

III. *Contributions to the Anatomy of Fishes.*—II. *The Air-bladder and Weberian Ossicles in the Siluroid Fishes.*

By T. W. BRIDGE, M.A., *Professor of Zoology in the Mason College, Birmingham,*  
and A. C. HADDON, M.A., *Professor of Zoology in the Royal College of  
Science, Dublin.*

*Communicated by Professor ALFRED NEWTON, F.R.S.*

Received June 9,—Read June 16, 1892.

[PLATES 11–19.]

CONTENTS.

	PAGE.
I. Introductory . . . . .	65
II. Historical . . . . .	67
III. Morphology . . . . .	67
IV. Morphological Summary . . . . .	224
V. Physiology . . . . .	261
VI. Concluding Remarks . . . . .	314
VII. List of Species described . . . . .	315
VIII. References . . . . .	322
IX. Description of Plates . . . . .	325
X. Reference Letters . . . . .	330

I. INTRODUCTORY.

WEBER, in his classical memoir entitled “*De aure et auditu Hominis et Animalium, Pars i., De aure Animalium aquatilium,*” published in 1820, was the first to show that in certain families of Physostomous Teleostei, viz., the Siluridæ and Cyprinidæ, there exists a peculiar connection between the auditory organ and the air-bladder, by means of a chain of movably interconnected ossicles. To these two families, and to three others, viz., the Characinidæ, Gymnotidæ, and Gymnarchidæ, in which this singular mechanism was subsequently discovered, SAGEMEHL (33) applied the collective name of Ostariophyseæ (*οσταριον*, ossicle; *φυση*, air-bladder), for the reason that the possession of this highly specialized mechanism implied community of descent. Since the publication of WEBER’S memoir, various contributions to this subject have been made, but deal for the most part either with special features, or with individual species, or with a very limited number of species in particular families. In no single family of Ostariophyseæ has any attempt at present been made to institute a systematic



and comparative examination of any considerable number of genera, and, at the same time, to deal with the various modifications which pertain to the air-bladder, auditory organ, and skeleton as correlated and mutually dependent factors. With regard to papers on such special points as the nature of the "complex" vertebra and the homologies of the Weberian ossicles, reference may be made to the contributions of BAUDELLOT (1), GRASSI (17), and NUSBAUM (29), and to a recently published and valuable paper by SÖRENSEN (37), which treats of certain skeletal modifications, not only in the Ostariophyseæ in general but in other Teleostei. Of papers dealing with other special points, the contributions of HASSE (19) and NUSBAUM (*loc. cit.*) to the anatomy of the auditory organ must also be mentioned. Of individual families, the Siluridæ have received but little attention. SAGEMEHL's paper deals mainly with the air-bladder of the Characinidæ. The papers of GRASSI, BAUDELLOT, and NUSBAUM relate almost exclusively to the Cyprinidæ. The valuable observations of SÖRENSEN, while more extensive as regards the families included within the range of his investigations, are nevertheless restricted to certain special features, and, apart from the development of ossifications in its walls, have but scanty reference to the air-bladder, or to the Weberian ossicles, or to the auditory organ in the relatively few Siluridæ described by him. WEBER (*loc. cit.*) himself only described the air-bladder and the ossicles which bear his name in a single species (*Silurus glanis*). JOHANNES MÜLLER, in his various contributions to the Berlin Academy during the years 1843-45, added somewhat to our knowledge of these structures, and notably by his discovery of the "elastic-spring" apparatus, but MÜLLER's attention was mainly directed to the grosser features in the anatomy of the air-bladder, to the entire exclusion of all but the slightest reference to the important skeletal modifications which are associated with the peculiar structure of that organ in the Siluridæ, or to the auditory ossicles. REISSNER (32) has given a fairly complete account of the singular bone-encapsuled air-bladder of *Rhinelepis*, but among the most valuable of recent contributions to this branch of vertebrate morphology are the papers by Professor RAMSAY WRIGHT relating to the aberrant Siluroid *Hypophthalmus* (44), and to the more normal North American species *Amiurus catus* (42, 43), to which reference will subsequently be made. In this connexion reference may also be made to the numerous scattered references to the air-bladder of the Indian-Siluridæ contained in the papers of the late Dr. FRANCIS DAY (9, 10), which, although often too brief, in several instances at any rate are valuable as throwing some light on the degenerate condition of that organ in certain rare abnormal forms.

It is remarkable that this important family of Fishes has so little occupied the attention of morphologists, especially when we take into consideration the interesting modifications which its various members have undergone, and the fact that in this family the air-bladder and "auditory" ossicles are subject to greater variations, and are more highly specialized than in any other group of Ostariophyseæ. Probably the main reason why the Siluridæ have been so much neglected is due to the fact that

they are principally tropical in habitat, or live in remote and inaccessible districts. Investigators at home are consequently dependent upon the exertions of collectors, who, as a rule, do not pay much attention to Fishes, and the relatively few species which do find their way to Europe are required for museum specimens. Fortunately for us we had the opportunity of purchasing the third series of the Siluroids collected by that eminent ichthyologist, the late Dr. BLEEKER, who had amassed a magnificent collection of East Indian Fishes, amongst which the Siluridæ were well represented. Subsequently we added to our collection what other specimens we were able to procure, especially African and South American species.

The object of the present communication is to give the results of a detailed study of the morphology of the air-bladder, and "auditory" ossicles, and the associated skeletal modifications in 100 species of Siluridæ, referable to 51 genera, and mainly belonging to Dr. GÜNTHER'S sub-families of Siluridæ Homalopterae, S. Heteropterae, S. Proteropterae, and S. Proteropodes.\* Most of the species examined and described by us have either not been the subject of any recorded observations, or the accounts already given are too brief to be of much value; in the few cases in which it is otherwise, references are given to what has previously been recorded.

The physiological significance of the so-called auditory ossicles is still an unsettled problem, and one of the objects of our investigations was to ascertain how far the morphological variations of the mechanism, and of the air-bladder and auditory organ, in a large series of forms were able to throw any light on this difficult question, and failing a satisfactory solution by such means, we shall be satisfied if our results are regarded as furnishing the experimental physiologist with a sufficiently wide and accurate basis of morphological data.

To our friend the late Dr. FRANCIS DAY, of Cheltenham, we are greatly indebted for the gift of numerous valuable specimens and for his kindness in identifying others. We greatly regret that he is not now living to receive this acknowledgment of our gratitude for his liberality and interest in our work. We are also indebted to Dr. GÜNTHER for the acquisition of one or two species, and for his courtesy in allowing us every facility in examining the collection committed to his care; and also to Dr. SIDNEY LAWRENCE, of Birmingham, for a small but valuable series of South American Siluroids collected by himself. We desire also to take this opportunity of thanking Professor J. H. POYNTING, F.R.S., and Dr. W. W. J. NICOL, of the Mason College, for information and valuable criticism on certain physical points, and the Council of the Royal Society for grants to one of us from the Government Research Fund in aid of these investigations.†

\* A preliminary abstract of this paper appeared in 'Roy. Soc. Proc.,' vol. 46, 1889. We may add as a personal explanation that this investigation was commenced by us several years ago, but for various unavoidable circumstances it had repeatedly to be laid on one side.

† The figures illustrating this Paper were drawn from nature by our draughtsman, Mr. HENRY BARNES, of Birmingham.

## II. HISTORICAL.

It is unnecessary for us to say anything under this head. Excellent historical summaries of the various views that have been held by different writers as to the modifications of the anterior vertebræ and the homologies of the "auditory" ossicles in the Ostariophyseæ generally, are to be found in the papers of BAUDELLOT (1) and SÖRENSEN (37).

## III. MORPHOLOGY.

In describing the morphology of the air-bladder and Weberian ossicles, and the nature of the modifications which the anterior vertebræ undergo in the various species of Siluridæ that we have had the opportunity of examining, we propose to follow the system of classification adopted by Dr. GÜNTHER in the British Museum Catalogue of this family (15) and to deal with the different species under the principal subdivisions to which they are referred in that work, commencing however with the sub-family Siluridæ Proteropteræ. A comparison of the species enumerated in the Catalogue with those described in our paper will to some extent indicate the range of our investigations. As we have followed Dr. GÜNTHER in the specific names, we have omitted the authorities for them in the text, but, in the few instances in which the species are not referred to in his Catalogue, the authority is given either in the text or in the index of species.

## SUB-FAMILY :—SILURIDÆ PROTEROPTERÆ.

## GROUP :—BAGRINA.

*Macrones nemurus.*

We select for detailed description, in the first place, the Javan species *Macrones nemurus*.

*The Vertebral Column.*—In this species certain of the anterior vertebræ, from the second to the seventh inclusive, are rigidly connected with one another, partly by the ankylosis of more or fewer of their centra, neural arches, and spinous processes, and partly, also, through the investment of the lateral surfaces of their centra by a continuous deposit of superficial bone. With the exception of those belonging to the second, third, and fourth vertebræ the distinctness of the different vertebral elements is, however, always more or less clearly indicated by the existence of well-marked intervertebral spaces between the centra, which are very obvious in a vertical longitudinal section of this region of the vertebral column, and by the presence of sutures between certain of the confluent neural arches. The neural spines, on the other hand (with the exception of those belonging to the third and fourth vertebræ which are fused, and the spine of the second vertebra which is absent), are distinct, although, for the most part they are firmly united together, but only by suture. Not only are the

anterior vertebræ inflexibly united together, but their connection with the skull is of an equally rigid character, and this is due to the firm articulation of the transverse processes of the fourth vertebra with the skull through the intervention of the post-temporal bones, to the articulation of the arch and spine of the third vertebra with the exoccipitals and supraoccipital, and to the development of strong, interlocking accessory articular processes on the basioccipital and the centra of the first and complex vertebræ.

We defer for the present any reference to the "auditory ossicles" as constituent elements of certain of the anterior vertebræ beyond remarking that in all probability the claustra and stapedes of WEBER respectively represent the neural spine and arch of the first vertebra, while the ossicles, termed incus and malleus by the same morphologist, respectively correspond to the arch of the second vertebra and the transverse process or rib of the third vertebra.

The centrum of the first vertebra (figs. 1, 2, 4, and 5, *v.*) is much smaller than any of the normal anterior vertebral centra, being represented by a thin discoidal and but slightly biconcave bone, wedged in between the concave posterior face of the basioccipital and the concave anterior face of the complex centrum. Its ventral surface is furnished with a pair of accessory articular processes which fit in between similar but much stronger paired processes developed from the ventral margin of the anterior extremity of the complex centrum, and also from the ventral surface of the posterior end of the basioccipital (figs. 4 and 5, *ac., p.*). On the dorsal surface of the centrum, near its lateral margins, there are two small cup-shaped sockets for the reception of the rounded condylar processes of the two "stapedes." The centrum is quite distinct from the basioccipital and complex centrum, although rigidly articulated to both.

The large vertebra which succeeds the first was regarded by WEBER (*loc. cit.*) as the second. BAUDELÔT (1), GRASSI (17), and NUSBAUM (29), however, subsequently showed that in the Cyprinidæ the apparent second vertebra is really formed by the complete coalescence of the centrum of the second vertebra with that of the third; and a precisely similar fusion was believed by them to have formed the "second" vertebra of WEBER in the Siluridæ; but more recently RAMSAY WRIGHT (42, 43) has demonstrated on developmental grounds that, in the latter family, this vertebra is even more complex, inasmuch as it represents, not only the elements already recognised by previous writers, but also, in addition, the centrum, arch, and spine of the fourth vertebra—or, in other words, the "second" vertebra of WEBER is formed by the complete coalescence of the third and fourth vertebræ with each other and with the centrum of the second. From RAMSAY WRIGHT'S account of the development of the anterior vertebræ in the North American Siluroid *Amiurus catus*, it would appear that the usual intervertebral growth of the notochord does not take place between the centra of the third and fourth vertebræ, so that the posterior concavity of the former and the anterior concavity of the latter are incompletely developed in the embryo and completely obliterated in the adult; and, further, that the second and third vertebral centra

become indistinguishably fused, with the final result that in the adult the three centra are ankylosed into one apparently simple centrum. Hence it follows that in *Amiurus* the first intervertebral enlargement of the notochord is between the basioccipital and the body of the first vertebra, the second between the latter and the second vertebral centrum, and the third enlargement between the centra of the fourth and fifth vertebræ. The same observer has also pointed out that the neural canal over this composite centrum is bounded by a continuous tube of membrane bone, which originates near, and apparently replaces in the adult, the rudimentary cartilaginous neural arches of the third and fourth vertebræ in the embryo. The neural spines of the two vertebræ, on the contrary, are free at their distal extremities, although proximally they are continuous with each other and with the tube of the membrane bone.

For convenience in descriptive anatomy we venture to propose for the confluent second, third, and fourth vertebræ the term "complex vertebra." The extent to which the second vertebral centrum enters into the composition of the complex centrum is not altogether clear. According to RAMSAY WRIGHT (42), it "serves apparently merely to deepen the anterior concavity of the third vertebra, although in horizontal sections through Fish of 3 to 4 cm. in length the second and third vertebræ appear of almost equal size." But, from the description and figures, it would seem that the second and third centra together form the anterior third of the complex centrum, the remaining two-thirds representing the body of the fourth vertebra. On similar grounds we may perhaps regard the anterior third of the continuous neural arch of the complex vertebra, which is perforated for the exit of the dorsal and ventral roots of the fourth pair of spinal nerves, as belonging to the third vertebra, and the posterior two-thirds, similarly perforated for the transmission of the fifth pair of nerves, as representing the neural arch of the fourth vertebra.

Returning to *Macrones nemurus*, we find that that the centrum of the complex vertebra is much larger than any of the normal centra, and has its posterior concavity much deeper than the anterior (figs. 2, 4, and 5, *c.c.*). On the ventral surface of the centrum, near its anterior extremity, there is a pair of nutrient foramina (figs. 2 and 5, *n.f.*). In some Siluridæ, but not in *Macrones*, there is a second pair behind the first, and in that case it is evident that the two pairs are the normal nutrient foramina for the third and fourth vertebræ. The anterior extremity of the complex centrum is provided on its ventral surface with a pair of stout accessory articular processes, which incline forwards towards the corresponding processes of the basioccipital, but remain separated from them by the more slender articular processes of the centrum of the first vertebra (fig. 5). The centrum of the fifth vertebra is of still greater length, being about equal in this respect to the complex and first centra taken together (fig. 2, *v.*<sup>5</sup>). Its anterior and posterior concavities are approximately equal in size, although the latter may sometimes be slightly the deeper of the two. Both the complex and fifth centra are not only greatly elongated but also laterally

compressed, so as to present the appearance of a median bony keel when viewed from the ventral surface. The sixth centrum is much smaller, but nevertheless somewhat larger than the normal or but little modified centra that succeed it (figs. 1 to 3, *v.*<sup>6</sup>). The body of the seventh vertebra (*v.*<sup>7</sup>) resembles the normal free vertebral centra, except that its ventro-lateral margins are over-lapped by the splint-like posterior prolongations of the superficial ossifications. The remaining vertebral centra are normal and free.

The neural arches of the third and fourth vertebræ form the continuous bony walls of the neural canal in the region of the complex centrum; posteriorly they appear to be completely ankylosed with the arch of the fifth vertebra, which in turn is partially confluent with the arch of the sixth vertebra, at all events only very faint indications of sutures can be detected between them (fig. 2). In young specimens the arches of the fifth and sixth vertebræ are readily separable from each other, and also as a rule from the arch of the complex vertebra, the completeness of the coalescence being largely dependent on the age of the particular specimen examined. The arch of the seventh vertebra is usually quite distinct from its fellows with which, like the normal free vertebræ, it articulates by means of pre- and post-zygapophyses, but in old specimens it also may become partially ankylosed to the arch in front.

In a vertical longitudinal section of this part of the vertebral column, the bony walls of the neural canal are seen to be perforated on each side by successive pairs of small foramina for the exit of the dorsal and ventral roots of the fourth to the eighth pairs of spinal nerves inclusive (figs. 2, 5, see also p. 98).

The second vertebra has no distinct neural spine. The spine of the third vertebra forms a thin vertical and much elongated lamina of bone, which, like its neural arch, is inclined forwards in front, and articulates with the exoccipitals and supraoccipital, and is also overlapped along the greater part of its free dorsal edge by a spine-like backwardly-projecting process, derived from the supraoccipital (figs. 1, 2, 4, and 5, *n.s.*<sup>3</sup>). The anterior margin of the lamina is much thickened, and, moreover, is slightly bifid, so as to clip, as it were, the posterior edge of the supraoccipital, at the junction of the latter with the two exoccipitals, but usually a small remnant of intercalated cartilage (fig. 5, *it.c.*) still persists between the two. The spine of the fourth vertebra is represented by a thickened spur of bone, of greater length than the foregoing, with which it is continuous anteriorly, and inclined obliquely backwards to such an extent as to overlap the much shorter and nearly vertical spines of the fifth and sixth vertebræ (fig. 2, *n.s.*<sup>4</sup>). Its distal extremity is free and deeply cleft, so as to clip, and thereby support, the central portions of the two anterior interspinous bones of the dorsal fin. The spinous processes of the fifth, sixth, and seventh vertebræ are much shorter, and so crowded together as to be with difficulty distinguishable as separate elements, although sutures exist between them as well as between the spines of the fifth and fourth vertebræ. Their distal extremities are bifid, and support the proximal extremities of

the first four interspinous bones (fig. 2). The succeeding spines are distinct and free from root to apex; they also are cleft to receive the remaining interspinous bones of the dorsal fin.

Between the forwardly inclined neural arch and spinous process of the third vertebra, behind and above, the body of the first vertebra below, and the posterior margin of the neural plate of the exoccipital in front, there is left on each side a somewhat triangular space where the lateral wall of the neural canal is formed only by a tough, fibrous membrane, in which the claustrum and the ascending processes of the "incus" and "stapes" are imbedded (figs. 1, 2, 4, and 5).

Neither the first nor the second vertebra has any trace of transverse processes, and in the third vertebra these structures may be represented by the two "mallei." The transverse processes of the fourth vertebra on the other hand are enormously developed, forming on each side of the complex vertebra an expanded wing-like lamina of bone, the flat root of which has its origin not from the centrum, but from the whole length of the continuous neural arches of the third and fourth vertebræ (figs. 1, 3, and 4, *t.p.*<sup>4</sup>). The under surface of each outgrowth is comparatively smooth, and slightly concave from before backwards, but its dorsal surface is traversed by one or two stout ridges radiating outwards from the neural arch. An oval cleft, near the anterior extremity of its distal margin, partially subdivides each lamina into an anterior and a posterior division, of which the former is somewhat the longer of the two (*t.p.*<sup>4a</sup>, *t.p.*<sup>4p</sup>). The anterior division (*t.p.*<sup>4a</sup>) has a thick root, continuous behind with the thinner and more lamellar posterior division, which bends slightly downwards towards its distal end, and is ultimately prolonged into a slender free process that curves sharply downwards and then outwards and a little backwards, the concavity of the curvature being directed outwards (fig. 3, *tp.*<sup>4a</sup>). At the extremity of the thickened proximal portion of the division, where the latter joins its crescentic distal prolongation, there is an oval facet which looks forwards and outwards, and articulates with a similar articular facet on the inferior limb of the post-temporal bone, near the ventral margin of the post-temporal plate (figs. 1 and 4, *pt.f.*). The posterior division (*tp.*<sup>4p</sup>) is broad and comparatively thin, except that its dorsal surface is strengthened by a stout oblique ridge extending outwards from the neural arch towards the distal margin of the process. Its posterior edge overlaps and is partially anchylosed to the proximal half of the succeeding transverse process, leaving however the distal portion as a broad, free process of bone (figs. 1 and 3). Unlike the anterior division, the posterior is horizontally disposed and bears a greater resemblance to a normal transverse process in being directed slightly upwards as well as outwards. Except for its greater length, and the width of its root, which, like that of its predecessor, springs from the arch of its vertebra, the transverse process of the fifth vertebra more nearly resembles an ordinary rib-bearing process. The distal end is free, being separated by an oval cleft from the process in front, but proximally the two are confluent (figs. 1 and 3, *tp.*<sup>5</sup>).



It will be obvious that the modified transverse processes of the fourth and fifth vertebræ combine to form on each side of the complex and fifth vertebræ an almost continuous bony plate, with a smooth and slightly concave ventral surface and a strongly deflected anterior margin, which is adapted and intimately applied to the convex dorsal and anterior walls of the anterior third of the air-bladder.

The transverse processes of the sixth vertebra are normal except for the slight coalescence of their roots with the corresponding processes of the fifth vertebra. Their origin is from the centrum and not from the neural arch, and their distal extremities carry the first pair of ribs (figs. 1 and 3, *tp.*<sup>6</sup>, *r.*').

Each of the lateral surfaces of the complex centrum is traversed close to its anterior margin by a faint ridge (fig. 4, *l.r.*), which, commencing at the base of the accessory articular processes, passes obliquely backwards and upwards, and apparently indicates the anterior limit of the superficial bony deposit which invests both sides of the centrum. To the dorsal portion of this ridge, which may be called the "lateral ridge" of the complex centrum, there is firmly attached, but except in old specimens not actually confluent with it, an elongated nodule of bone which terminates at its dorsal extremity in a thickened nodular prominence (figs. 3 and 4, *r.n.*). From the relations of this ossicle to the radial fibres of the malleus we shall in future refer to it as the "radial nodule." The radial nodule generally coincides with the junction of the anterior third of the complex centrum with the posterior two-thirds, and according to RAMSAY WRIGHT, by whom, in *Amiurus*, it is apparently referred to as the "oblique ridge," indicates the line of union of the third and fourth vertebral centra in the formation of the complex centrum. In young specimens the nodule is united by fibrous tissue only to the lateral ridge but in older forms appears to become firmly ankylosed thereto. From the thickened dorsal extremity of the radial nodule, but separated therefrom in young specimens by a well-marked suture, a thin, narrow strip of bone (fig. 3, *d.l.*) extends obliquely backwards and outwards ventrad to the cardinal groove, which, in consequence, becomes at this point a complete canal, and ultimately passes on to the ventral surface of the posterior division of the transverse process of the fourth vertebra, and blends therewith by its anterior margin and pointed distal extremity, leaving, however, its posterior edge projecting in the form of a faint ridge. In mature or old specimens this process, which we shall call the "dorsal lamina," and the lateral ridge, form a continuous obliquely-disposed ridge of bone stretching from the side of the complex centrum to the transverse process of the fourth vertebra, the radial nodule then appearing as a small nodular projection from its surface.

A thin but continuous superficial ossification more or less completely invests each side of the complex and fifth centra, and obscures all external indication of the intervertebral suture which separates them (figs. 1 and 3, *s.os.*). Each ossification is somewhat triangular in shape, with the broad base coincident with the ventro-lateral margins of the two centra, and its anterior and posterior margins converging towards the flattened root of the transverse process of the fourth vertebra, where the

apex terminates beneath the cardinal groove (*cd.g.*) by becoming suturally united with the oblique posterior or inner margin of the dorsal lamina (fig. 3). The anterior margin of each ossification coincides with, and indeed, appears to form, the oblique lateral ridge of the complex centrum. Traced posteriorly, each superficial ossification gradually contracts and partially exposes the lateral surface of the fifth vertebral centrum, but is, nevertheless, continued as a narrow splint of bone along the ventro-lateral edge of the succeeding centra as far as the seventh (fig. 3). The free ventral margins of the two ossifications and their splint-like prolongations project downwards beyond the ventral surfaces of the different vertebral centra with which they are in relation, so as to form the lateral boundaries of a deep but narrow median groove extending from the first to the seventh vertebra (figs. 3 and 23, *a.g.*). The lateral margins of the anterior extremity of the groove are formed by the paired accessory articular processes of the basioccipital and the centra of the first and complex vertebræ. The groove has a fibrous ventral wall, in part, at least, formed by the median portion of the dorsal wall of the anterior chamber of the air-bladder, and in the canal, so constituted the anterior section of the dorsal aorta is lodged. In the dry skeleton paired nutrient foramina may be seen in the dorsal wall of the groove, leading into the different vertebral centra; of these foramina one pair only belongs to the complex centrum (fig. 3). Between the dorsal edge of each superficial ossification and the root of the transverse process of the fourth vertebra, the lateral surface of the complex centrum is traversed by a deep groove which, anteriorly, is converted for a short distance into a complete canal by the extension of the dorsal lamina from the radial nodule to the ventral surface of the transverse process (fig. 3, *cd.g.*). Through this groove and short canal, the posterior cardinal vein passes forwards to its junction with the anterior cardinal in front, the union of the two veins to form the Cuvierian duct taking place in a somewhat triangular fossa situated immediately anterior to the radial nodule. The attenuated anterior lobes of the mesonephros accompany the posterior cardinal veins as they extend forwards to their terminal lymphoid enlargements in front of the air bladder. In correspondence with the asymmetrical development of these veins the left cardinal groove is much narrower than the right.

It will be noticed (fig. 3) that the dorsal edge of the posterior half of each superficial ossification forms the ventral lip of the cardinal groove of its side, and also, in conjunction with the hinder margin of the dorsal lamina, gives rise to a  $\Lambda$ -shaped ridge, the two arms of which converge from the ventro-lateral margins and sides of the fifth and sixth vertebral centra, and from the ventral surface of the transverse process of the fourth vertebra, eventually uniting on the root of the latter, near the junction of the body of the fifth vertebra with the complex centrum. These converging ridges coincide with the line of attachment of the dorsal margins of the primary transverse septum of the air-bladder to the skeleton.

It is mainly owing to the growth of the investing superficial ossification and their downward projection beyond the ventral margins of the anterior vertebral centra that

the vertebral column presents the appearance of a thin, laterally compressed, median bony keel, when viewed from the ventral surface.

*The Cranium.*—In common with all Siluroid Fishes the skull in *Macrones* exhibits not a few features wherein it differs considerably from the normal Teleostean type, but we shall here refer in detail only to such of its structural peculiarities as are more or less closely correlated with certain characteristic modifications of the membranous labyrinth of the internal ear.

The dorsal surface of the hinder part of the skull (figs. 1 and 4) is formed by the supraoccipital (*s.o.*), the epiotic (*ep.o.*), the pterotic (*pt.o.*), and the sphenotic (*sp.o.*) bones. In the absence of distinct parietal bones the supraoccipital is exceptionally large; anteriorly it is deeply cleft by the posterior cranial fontanelle, while posteriorly it is produced into a spine-like process which extends backwards dorsad to the confluent spines of the third and fourth vertebræ as far as the first interspinous bone of the dorsal fin (fig. 1, *so.*<sup>1</sup>). Laterally, the supraoccipital articulates with the epiotics, pterotics, and sphenotics; anteriorly with the frontals, and below with the exoccipitals. The posterior face of the bone, immediately over the foramen magnum, is traversed by a median ridge which, superiorly, is confluent with the horizontally flattened root of the supraoccipital spine (fig. 6), and on each side of the ridge, just beneath the root of the spine, there is a small foramen for the transmission of the lateral branch of the fifth cranial nerve (fig. 6, *V.*<sup>1</sup>).

Each exoccipital (figs. 1 to 7, *eo.*) consists of a thin, laterally compressed neural plate, which is situated at the side of the foramen magnum, and meets the supraoccipital above, and, in addition, is prolonged forwards into the cranial cavity as a vertical plate of bone, the free anterior edge of which forms the posterior boundary of a large aperture leading from the general cranial cavity into a spacious lateral recess in which the utricle and its semicircular canals are lodged (figs. 2 and 5, *eo.*<sup>1</sup>). From the outer surface of its neural plate each exoccipital gives off a posterior plate which extends outwards at right angles to the foregoing on to the hinder face of the skull and there articulates dorsally with the supraoccipital and the epiotic (fig. 6, *eo.*<sup>2</sup>). The posterior plate eventually extends round the postero-lateral angle of the cranium on to the lateral surface, where it occupies the place normally taken by the opisthotic in most other Teleostean Fishes, meeting the prootic in front, the lateral margin of the basioccipital below and the pterotic and epiotic bones above (figs. 3 to 5, *eo.*<sup>3</sup>). The opisthotic plate of the exoccipital is extremely thin, and, in the complete absence of a true opisthotic element, is in relation internally with the inferior part of the arch of the posterior vertical semicircular canal. A small foramen perforates the anterior margin of the plate, near its junction with the prootic, and transmits the glosso-pharyngeal nerve (fig. 4, *IX.*), and somewhat more posteriorly there is a much larger aperture for the exit of the vagus (*X.*). The hypoglossal or first spinal nerve emerges from the cranial cavity through a small foramen in the posterior plate, situated in the lower part of the angle which the latter makes with the neural plate (fig. 4, *sp.n.*<sup>1</sup>).

The basioccipital (figs. 1 to 8, *b.o.*) has a concave posterior face provided on its ventral margin with a pair of stout accessory articular processes for articulation with a pair of precisely similar processes on the adjacent ventral edge of the centrum of the first vertebra (figs. 4 to 6). Anteriorly to these and on each of its lateral surfaces the basioccipital is furnished with a pair of short but stout processes for articulation with the doubly-faceted inner extremity of the inferior limb of the post-temporal (figs. 1, 4, and 6). Midway between the two series of articular processes the ventral surface of the basioccipital is perforated by a single median nutrient foramen (fig. 3). Dorsally the bone suturally articulates with the inferior margins of all three exoccipital plates.

The superior or cranial surface of the basioccipital is deeply excavated to form the floor, and to some extent the side walls also, of three fossæ, one median, the "cavum sinus imparis" of WEBER, and two lateral, the "foveæ sacculi." Horizontal ingrowths from the inner surfaces of the exoccipitals meet over the dorsal surface of the basioccipital and either fuse or remain separated by a median suture, thereby forming a thin bony roof for the three fossæ, and, at the same time, a section of the cranial floor on which the medulla oblongata rests (figs. 6 to 8, *e.o.*<sup>4</sup>). The floor and side walls of the cavum sinus imparis are furnished by the basioccipital alone, and its roof by the horizontal exoccipital plates; the floor and inner walls of the foveæ sacculi are also supplied by the basioccipital, their thin roof by the exoccipitals, but the thin outer walls are mainly formed by the inferior margins of the opisthotic plates of the exoccipitals (figs. 5, 7 to 9, *c.s.i.*, *f.s.*). A comparison of these figures will sufficiently illustrate the mode of formation and mutual relations of the three fossæ. In fig. 8 the roof of the skull has been removed in order to show the floor of the cranial cavity and the horizontal plates of the exoccipitals *in situ* (*e.o.*<sup>4</sup>). In fig. 9 these plates have been partially removed so as to expose the cavum (*c.s.i.*) and foveæ (*f.s.*), and their respective contents the sinus endolymphaticus (*s.e.*) and the two sacculi (*s.*). Fig. 5 represents a vertical longitudinal section through the cranium, bisecting the cavum sinus imparis (*c.s.i.*); while fig. 7 was drawn from a transverse section through the hinder part of the skull of *Macrones aor*, and shows the cranial cavity separated from each utricular recess by the intracranial prolongation of the neural plate of the exoccipital (*e.o.*<sup>4</sup>), and also the relative positions of the cavum and the two foveæ (*c.s.i.*, *f.s.*). From fig. 7 it will be apparent that the cavum and the foveæ lie parallel to one another, but inasmuch as the latter are situated more towards the sides of the basioccipital they occupy a slightly lower level, and individually are, perhaps, somewhat smaller than the former.

The foveæ sacculi end blindly behind but in the dry skeleton the cavum sinus imparis communicates by means of a triangular and slightly constricted aperture with the neural canal over the hinder edge of the basioccipital (figs. 5, 6, and 8, *c.s.i.*). This aperture may be readily seen in a view of the posterior face of the skull, beneath the hinder margin of the roof of the cavum (figs. 6 and 8, *c.s.i.*). In the

fresh specimen, on the contrary, the aperture places the cavum in communication with two small laterally-situated cavities which lie on the dorsal surface of the hinder part of the basioccipital, behind the posterior edge of the bony roof of the cavum, and have partly osseous and partly thick fibrous walls—the “atria sinus imparis” of WEBER. In figs. 4, 5, and 8, it will be noticed that the posterior edge of each exoccipital, beneath the origin of its horizontal plates that roof in the cavum sinus imparis and foveæ sacculi, is deeply notched by a semicircular emargination; this notch forms the anterior half of the external atrial aperture, or “apertura externa atri” of WEBER, which normally is completely closed by the spoon-shaped process of the stapes of its side. Anteriorly the cavum and foveæ open into a deep transverse groove in the cranial surface of the basioccipital, situated just in front of the anterior margin of their bony roof (figs. 5 and 8, *t.g.*). The opening of the cavum is by means of a relatively small and somewhat triangular median aperture; the foveæ by two laterally situated, relatively large, and somewhat rounded orifices (fig. 5, *f.s.*) On each side the transverse groove communicates by a deep, but narrow, slit-like prolongation with the lateral recess of the cranial cavity (*ut.r.*) in which the utriculus and its semicircular canals are lodged (figs. 5 and 8, *l.g.*). The transversely disposed groove contains the ductus endolymphaticus, and its slit-like lateral prolongations, the ductus sacculo-utricularis of that side (fig. 9, *d.e., d.s.u.*). At the bottom of the transverse groove the dorsal surface of the basioccipital is raised into a sharp median ridge (fig. 8) which divides behind as it passes beneath the horizontal roofing plates of the exoccipitals into two divergent vertical ridges, and these by their union above with the exoccipital plates form the outer walls of the cavum sinus imparis and at the same time the inner walls of the two foveæ sacculi (fig. 7). Anteriorly also the ridge divides, but into two horizontally diverging arms which together form the anterior rim of the transverse groove (fig. 8). In front of the transverse groove the two prootics meet in a median suture in the floor of the cranial cavity. In close proximity to this suture the posterior margin of each prootic is produced into a slender, backward-projecting spur of bone which forms the anterior lip of the groove for the ductus sacculo-utricularis and also overlies the entrance to an excavation in the substance of the prootic into which the contracted anterior extremity of the sacculus penetrates.

As is the case in all Teleostei the inner wall of each auditory capsule is deficient and hence the latter appears as a deep lateral recess of the hinder part of the cranial cavity (figs. 5 and 8, *ut.r.*). Externally each recess is bounded by the prootic, sphenotic, pterotic, and epiotic bones, and also by the posterior opisthotic plates of the exoccipital; internally, each recess is in wide communication with the general cranial cavity. The entrance to each recess from the cranial cavity is bounded by two prominent ridges, one in front and the other behind, which slightly constrict the communication between the two cavities (fig. 5). The anterior ridge is developed from the inner surface of the prootic, and its free edge is directed obliquely backwards,

while the posterior ridge, which is really the intracranial prolongation of the neural plate of the exoccipital, looks directly forwards. Each recess is prolonged backwards to the outer side of this portion of the exoccipital until it becomes closed behind by the posterior plate of the same bone and by the epiotic. (See transverse section of this part of the skull in fig. 7.)

In places the outer walls of the auditory capsules are extremely thin, and this is notably the case where they are formed by the epiotic and prootic bones and by the opisthotic plates of the exoccipitals. Over definitely circumscribed areas these bones are almost transparent when the skull is held up to the light.

Although foreign to the subject of this paper, it may be mentioned that at each postero-lateral angle of the skull there is a deep fossa, closed internally but open externally, and formed by the opposition of correlated grooves in the pterotic and epiotic in front and behind respectively, and by the supraoccipital internally and superiorly (figs. 1, 4, and 6, *tp.f.*). RAMSAY WRIGHT (43), in his description of the skull of *Amiurus catus*, throws out the suggestion that these fossæ may be the atrophied rudiments of somewhat similar cavities described by SAGEMEHL\* as present in *Amia calva*, and by him termed the temporal fossæ. In *Macrones* each fossa fulfils the function of an articular cavity for the proximal extremity of the ascending process of the post-temporal (fig. 6).

*The Pectoral Girdle.*—The post-temporal (supra-clavicle of RAMSAY WRIGHT and others) is the only element of the shoulder-girdle that, for our purpose, requires any special description.

As in most other Teleostei, the post-temporal is somewhat V-shaped, its two divergent arms articulating with the postero-lateral angle of the skull and its stem with the proximal extremity of the clavicle (figs. 3 and 6). Of the two arms, one, the ascending process, is somewhat loosely inserted into the temporal fossa of its side (fig. 6, *pt.a.*), while the other, or inferior limb (*pt.i.*), articulates by a doubly-faceted step-like inner extremity with a pair of suitably modified processes on the lateral surface of the basioccipital. Externally the two processes converge, and eventually unite to form the post-temporal stem (fig. 6, *pt.s.*). The latter is a flattened process of bone continuous superiorly with the ascending process, and so superficially situated that its outline is readily seen on the external surface of the body behind the posterior edge of the operculum (fig. 15, *pt.*). From the inner surface of the stem, and also from the adjacent ventral margin of the inferior limb, a relatively thin, transversely-disposed plate of bone grows downwards, and is so arranged that its two surfaces look directly forwards and backwards respectively (figs. 3 and 6, *pt.p.*). The posterior face of each plate is comparatively smooth, and at the same time faintly concave, and, moreover, is so applied to the crescentic extremity of the anterior division of the transverse process of the fourth vertebra as to fill up the concavity of the latter, and

\* "Beiträge zur vergl. Anat. der Fische. Das Cranium von *Amia calva*." 'Morphol. Jahrbuch, vol. 9, 1883.

also project outwards beyond it (fig. 3). In fact, the outer portion of the post-temporal plate completes the circumference of a circular bony structure, of which the ventral and inner margins are furnished by the crescentic process. The latter also helps to slightly deepen the concavity of the posterior face of the plate by strengthening as it were its inner and ventral lips. Along the dorsal and inner margins of the posterior face of each plate there is a curved facet for articulation with a similarly shaped surface on the adjacent anterior edge of the root of the crescentic process (fig. 6, *f.*). The anterior face of the plate, which is greatly thickened towards the centre, is somewhat convex, and is also traversed by a groove continued dorsally into a deep tubular socket for the reception of the slender proximal extremity of the clavicle (fig. 6, *cl.s.*). Both the post-temporal plate and the stem of the bone are on each side firmly united to the crescentic extremity of the transverse process by ligamentous fibres, which, in turn, blend with the lateral margins of the transverse and aponeurotic membranes (*vide* p. 88). The union of each plate with the crescentic process is further strengthened by a strong ligament which passes between the concave margin of the latter and a slight depression near the inner edge of the posterior face of the former (fig. 3, *lgt.*). The post-temporal plates and the two crescentic processes combined form two slightly concave bony structures which are closely applied to the corresponding lateral portions of the anterior wall of the air-bladder (fig. 3).

The clavicle (fig. 3, *cl.*), in addition to a slender head articulating with the post-temporal in the manner described, has a well-marked posterior process projecting backwards dorsad to the articulation of the pectoral fin, but considerably ventrad to the distal extremities of the modified transverse processes of the fourth and fifth vertebræ (*cl.p.*).

The lateral line canal traverses a well-marked groove in the outer surface of the ascending process of the post-temporal as it passes forwards from the lateral surface of the trunk to the skull.

*The Auditory Organ.*—We are not acquainted with any recorded observations as to the structure and relations of the various parts of the membranous labyrinth in *Macrones*, and the results of our own dissections are such that we have but little to add that is not merely confirmatory of the investigations of previous observers in other Siluroids, but as so very few species have been examined a brief description of the internal ear of *Macrones* may not be altogether superfluous.

A comparison of figs. 8 and 9 will serve to indicate the relations of the different factors of the membranous labyrinth to one another and to the osseous chambers in which they severally lie. In fig. 9, the fibrous roof of the atria sinus imparis has been removed, and also the bony roof of the cavum sinus imparis and foveæ sacculi, so as to show the mutual relations of the two sacculi, the sinus endolymphaticus, and the ductus endolymphaticus to one another and to the rest of the internal ear, as well as the relations of the sinus endolymphaticus to its cavum and to the two atria into which the latter opens posteriorly.

The utriculus (fig. 9, *ut.*) is a somewhat oblong sac lying in, but without completely filling, the utricular recess (figs. 7 and 8, *ut.r.*), and sharply constricted off from the sacculus (fig. 9, *s.*) although connected with the latter by a short but comparatively narrow ductus sacculo-utricularis (*d.s.u.*). The three semicircular canals connected with each utriculus traverse the various periotic bones with which they are in relation for only a very limited portion of their extent, and for the most part lie free in the utricular recess. The arch of the posterior vertical canal (*p.v.c.*) traverses the supraoccipital and epiotic; the horizontal canal (*h.c.*) occupies a groove on the inner surface of the epiotic, and for the remainder of its course a short canal in the pterotic; the anterior vertical canal (*a.v.c.*) has its arch but slightly protected by a short canal in the prootic and a deep groove in the sphenotic. An oblique valve, similar to that described by RAMSAY WRIGHT (43) in the case of *Amiurus catus*, is also to be found in the narrow lumen of the ductus sacculo-utricularis of *Macrones*.

The sacculus (fig. 9, *s.*) is an elongated sac, expanded and somewhat pear-shaped behind, but tapering in front. Its narrow anterior extremity penetrates into a slight excavation in the hinder margin of the prootic, but the posterior portion, with its lagæna cochleæ, occupy a bony chamber of a similar shape—the fovea sacculi—the formation of which has already been described. From the inner surface of the sacculus, before the latter enters its fovea, a thin-walled transverse duct is given off, which extends inwards, and in the median line of the floor of the cranial cavity joins the corresponding duct of the opposite side, and the two together constitute the transversely disposed ductus endolymphaticus (*d.e.*). The ductus occupies the deep transverse groove in the cranial surface of the basioccipital (figs. 5 and 8, *t.g.*), while the ductus sacculo-utricularis traverses a slit-like groove leading from the transverse groove into each utricular recess (*l.g.*). At a point where the two canals unite the ductus endolymphaticus gives off a median, pear-shaped, and extremely thin-walled sinus endolymphaticus (the “sinus impar” of WEBER) which projects backwards into, and almost fills, the cavum sinus imparis (fig. 9, *s.e.*).

In our description of the mode in which the cavum sinus imparis and the foveæ sacculi are formed we stated that the latter were closed behind, but that the former in the dry skeleton, communicated freely with the neural canal over the dorsal surface of the hinder part of the basioccipital. In the fresh specimen, on the contrary, the cavum widens out round the blind posterior extremities of the two foveæ into two small, laterally-situated, and nearly spherical cavities (the “atria sinus imparis” of WEBER) which lie on the upper surface of the posterior part of the basioccipital, and have partly bony and partly fibrous walls (fig. 9, *at.*). The roof of the atria is formed anteriorly by an extension backwards of the bony roof of the cavum sinus imparis, and posteriorly by a prolongation forwards of the fibrous posterior wall. The posterior wall of the two atria is formed by a thick mass of fibrous tissue (*p.w.*) which rests on the dorsal surface of the centrum of the first vertebra, between the pit-like sockets for the reception of the two condylar processes of the stapedes, and



dorsally is continued forwards as a roof to the atria, as far as the hinder edge of the roof the cavum sinus imparis, where it apparently becomes continuous with the very thin layer of dura mater investing the inner surface of the cranial bones. In the anterior wall is the median foramen, through which the two atrial cavities freely communicate with the cavum sinus imparis, but on each side of this the anterior wall is formed by the concave posterior edge of the root of the exoccipital. The floor of the atria is formed by the basioccipital, while their outer walls coincide with two deep semicircular notches in the posterior margins of the exoccipitals. The notch in each exoccipital, with the adjacent dorso-lateral margin of the basioccipital, form the anterior, superior, and inferior boundaries of a lateral orifice (*at.a.*), the "apertura externa atri" of WEBER—by which each atrium would communicate with the exterior of the skull were it not that the aperture is completely closed by the spoon-shaped extremity of the "stapes" of its side (fig. 9, *sc.s.*, also figs. 4 and 5, *at.a.*). The posterior boundary of each external atrial aperture is formed by the same thick mass of fibrous tissue that forms the posterior atrial wall. The inwardly curved inferior extremities of the two claustra lie immediately over the external atrial apertures, and may help to strengthen their dorsal lips, and possibly also contribute to the support of the atrial roof. The two atrial cavities are in open communication with each other and with the cavum sinus imparis anteriorly; in fact, if it were not for a thick vertical ridge of fibrous tissue projecting inwards from the median line of their posterior wall (fig. 9), they might be regarded as constituting a single transversely-disposed chamber. Essentially, the two atria may be considered as forming a bilobed posterior prolongation of the cavum sinus imparis excavated in the substance of a thick mass of fibrous tissue which forms the floor of the neural canal over the body of the first vertebra and the contiguous dorsal surface of the basioccipital. The fibrous tissue forming the roof and posterior wall of the atrial cavities is continuous laterally with the fibrous walls of the neural canal between the arch of the third vertebra behind, and the exoccipitals in front.

In his account of these structures in *Amiurus*, RAMSAY WRIGHT (43) describes an anteriorly bilobed median excavation in the substance of the tissue overlying the medulla oblongata which is said to communicate on each side with the atrial cavities. This excavation or receptaculum dorsale is described as being "filled with the same fluid contents as the atria and cavum." A precisely similar receptaculum exists in *Macrones*, and communicates with the atrial cavities by an aperture, which, on each side, perforates their fibrous roof near the superior border of the spatulate portion of the "stapes."

From the position and relations of the various factors of the membranous labyrinth and of the bony chambers or recesses in which they lie, it will follow that the perilymph will not only surround the utriculus and semicircular canals, but also extend into the foveæ sacculi and cavum sinus imparis, and surround their

respective contents, the sacculi and sinus endolymphaticus, eventually filling the two atrial cavities and bathing the inner surfaces of the spoon-shaped processes of the "stapedes."

*The Weberian Ossicles.*—A series of moveably interconnected ossicles which, morphologically, are modified portions of the three anterior vertebræ, serve to connect the membranous labyrinth with the air-bladder and thereby establish close physiological relations between the two structures. As we have already pointed out, the most anterior of these in *Macrones* fits into and completely closes the external atrial aperture of its side and is therefore in contact by its inner surface with the perilymph; the most posterior of its ossicles has the hinder half imbedded in the dorsal wall of the anterior chamber of the air-bladder. Fig. 24 shows the general relations of the ossicles to one another, and to the membranous labyrinth and air-bladder, and in figs. 3 to 5 they are represented as they appear *in situ*.\*

In *Macrones* each claustrum (figs. 4, 5 and 10, *c.*) is imbedded in the fibrous wall of the neural canal between the arch of the third vertebra and the exoccipital, and lies at the side of the foramen magnum, immediately behind, and almost in contact with, the posterior edge of the neural plate of the exoccipital. It is a slender spicular bone, slightly curved at its lower extremity where it is received into the angle between the ascending and spatulate processes of the scaphium, and separated by the somewhat contracted root of the latter process from the body of the first vertebra (figs. 4 and 5, *c.*). The upper extremity of the ossicle is in contact with, and may even extend into, the intercalated cartilage between the spine of the third vertebra and the supraoccipital, while the inferior incurved extremity coincides with the level of the posterior margin of the roof of the cavum sinus imparis and extends into and helps to strengthen the roof of the atrial cavity of its side. Although in close contiguity with the scaphium by its lower extremity, the claustrum is not specially attached to it, nor does it appear that the claustrum can in any way control or influence the movements of the scaphium.

The scaphium (figs. 10 and 11, also figs. 4 and 5, *sc.*) lies just behind the claustrum, and consists of two processes united at a right angle, an ascending process (figs. 10 and 11, *sc.a.*) and a horizontal or spatulate process (*sc.s.*). The former is imbedded in the fibrous wall of the neural canal behind and parallel to the claustrum (figs. 4 and 5, *sc.a.*), and consists of a slender spicule of bone with a slight forward curvature and a pointed upper extremity; the latter, which has its origin from the inferior extremity of the ascending process by a somewhat contracted root, passes

\* For reasons already given (5), we have suggested that the names applied to three of these ossicles, by WEBER, viz., "malleus," "incus," and "stapes," may, with advantage, be replaced by "tripus," "intercalarium," and "scaphium," respectively, retaining, however, the term "claustrum" for the fourth ossicle, while for the ossicles collectively, we suggested the name "Weberian" in preference to "auditory."

horizontally forwards over the dorso-lateral edge of the centrum of the first vertebra and beneath the lower extremity of the claustrum, and finally terminates on the lateral margin of the dorsal surface of the basioccipital in a characteristic spoon-shaped expansion, which is concave on its inner surface and convex externally (figs. 4 and 5, *sc.s.*). The spatulate process is so adapted, as regards shape and size, as to accurately fit into and completely occupy the semicircular notch in the posterior margin of the exoccipital, and consequently to form by its inner concave surface the outer wall of the atrial cavity of its side, and completely close the corresponding external atrial aperture (figs. 4, 5, and 9, *sc.s.*). The margin of the concavo-convex portion of the spatulate process is attached by fibrous tissue to the lips of the atrial aperture, but the connection is nevertheless sufficiently loose to admit of the process undergoing a slight inward or outward movement, according to the direction in which the scaphium rotates on its condylar process, and any such movement will necessarily lead to a slight diminution or increase in the size of the atrial cavity. Enlargement of the atrial cavities will take the form of lateral extension round the concave posterior edge of the root of the exoccipital (*vide* fig. 8, *at.a.*). On the inferior side of the junction of the spatulate and ascending processes there is a small spherical cartilage-tipped condyle, which fits into a cup-shaped socket provided for it on the dorso-lateral surface of the centrum of the first vertebra (figs. 10 and 11, *sc.c.*; also fig. 5, *sc.*). The inner extremity of a stout tendinous interossicular ligament is attached to the outer surface of the spatulate process, and serves to connect the scaphium with the anterior extremity of the tripus (fig. 12, *i.lg.*, also figs. 9 and 4).

Like the scaphium the intercalarium consists of ascending and horizontal processes united at nearly a right angle (figs. 9 to 12, *in.*, also figs. 4 and 5). Both processes are extremely slender and brittle. The ascending process (fig. 10, *in.a.*) lies in the fibrous wall of the neural canal behind and parallel to the corresponding process of the scaphium and immediately in front of the arch of the third vertebra (figs. 4 and 5, *in.*). At its lower extremity the process becomes continuous by a slightly open curvature with the horizontal portion of the ossicle (figs. 10 and 12, *in.h.*). The latter process is directed outwards and a little forwards, and eventually terminates in a discoidal expansion imbedded in the substance of the interossicular ligament exactly midway between the insertion of the latter into the spatulate process of the scaphium and its external attachment to the anterior end of the tripus (fig. 12, *in.h.*). The intercalarium differs from both the tripus and scaphium in having no connection or articulation with any vertebral centrum or other part of the skeleton; nevertheless, its ascending process is capable of a limited amount of rotation on its own axis as the horizontal process moves backwards or forwards with the lateral motion of the tripus and the consequent pull of the interossicular ligament.

The interossicular ligament (figs. 9, 12, 21, and 22, *i.lg.*; also fig. 4) is a short but relatively to its length, extremely thick, transversely-disposed ligament, composed of glistening tendinous fibres of a yellowish colour, and stretching between its attach-

ment to the outer surface of the spatulate process of the scaphium internally and its insertion into the anterior extremity of the tripus externally. The insertion of the discoidal extremity of the horizontal process of the intercalarium into the middle of the ligament completely divides the latter into two portions, the fibres from the scaphium being inserted into the inner face of the disc, while those passing to the tripus have their origin from its external face.

The tripus (figs. 12 to 14, *tr.*) differs considerably in shape from both the scaphium and intercalarium, and is a much larger ossicle than either. In shape it is a thin flattened bone with its surfaces looking respectively upwards and downwards and its margins inwards and outwards. The whole extent of the outer margin is convex, but much more so posteriorly than anteriorly; its inner margin, on the other hand, presents two concavities, a very slight anterior one, but a much deeper one posteriorly. As the tripus passes forwards from its posterior insertion into the dorsal wall of the air-bladder to its ligamentous connection with the intercalarium and scaphium in front it lies along the lateral surfaces of the complex centrum and the body of the first vertebra, and for the hinder two-thirds of its extent is in close relation by its dorsal surface with the under side of the broad flat root of the transverse process of the fourth vertebra (figs. 3 and 4, *tr.a.*, *tr.c.*). The ossicle is divided into three well-marked and extremely characteristic processes which have much the same general relations to one another that the ramus, the condyle, and the angular process have in the Mammalian lower jaw. For reasons which will be sufficiently obvious we may designate them the anterior, articular, and crescentic processes. The anterior process (figs. 12 to 14, *tr.a.*) lies along, and parallel to, but by no means in contact with, the lateral surfaces of the body of the first vertebra and the anterior third of the complex centrum, or, more strictly speaking, in a line with the junction of the dorsal and lateral surfaces of those centra, but its anterior extremity projects so far in front of the centrum of the first vertebra as to be exactly opposite the external atrial aperture, and the convex outer surface of the spatulate process of the scaphium (figs. 4, 9, 21, and 22). The anterior process is a thin, flattened, lamina of bone, slightly convex along the outer margin, and as faintly concave on its inner border. The somewhat greater length of its outer as compared with the inner margin, gives to the truncated anterior extremity of the process a slightly thickened and nearly straight edge, which looks directly inwards towards the spatulate process of the scaphium, and it is to this thickened edge that the outer extremity of the interossicular ligament is attached. The crescentic process is a direct continuation backwards of the anterior process, and, like the latter, is thin and flattened, although much more slender. Normally, the whole of the process, with the exception, perhaps, of a small portion of its root, is imbedded in the tunica externa of the corresponding half of the dorsal wall of the anterior compartment of the air-bladder (figs. 18 and 19, *tr.c.*). The root of the crescentic process is in a line with the anterior process, but for the posterior two-thirds of its extent the process becomes more slender, and at the same time, rather

abruptly bent inwards upon itself, so that its posterior, or, more correctly, its inner extremity, which is slightly decurved, is in contact with the lateral surface of the complex centrum at a point behind and above the thickened dorsal extremity of the radial nodule (fig. 3). In shape the process greatly resembles a sickle, having its inner concave edge partially encircling the radial nodule, and its convex outer margin directed at first outwards, and then bent directly inwards. From the convex outer margin, and at the point where the process first commences to curve inwards towards the complex centrum, a slender heel-like process is given off which is directed outwards and a little forwards towards the antero-lateral angle of the air-bladder (figs. 12 to 14, *tr.h.*; also figs. 3, 18, and 19). Although not in actual contact, the crescentic process, the root of the transverse process of the fourth vertebra, is intimately related to its dorsal surface. The articular process of the tripus is a somewhat triangular outgrowth from the inner margin of the ossicle at the junction of its anterior and crescentic processes (figs. 12 to 14, *tr.ar.*). The process is flattened in a horizontal plane, and its upper and lower surfaces coincide in direction with those of the remainder of the ossicle. Near the anterior margin of its dorsal surface there is a thin vertical ridge, which slopes upwards towards the distal or inner extremity of the process, and then becomes a vertical elongated condyle (fig. 13, *dr.*). The condyle articulates with the lateral surface of the anterior third of the complex centrum, that is, the centrum of the third vertebra, at the bottom of the deep pit-like depression, situated immediately in front of, and dorsad to, the radial nodule. A vertical ridge also traverses the ventral surface of the crescentic process, commencing at the root of the heel-like process, and from thence extending obliquely forwards and inwards on to the ventral surface of the articular process (figs. 12 and 14, *v.r.*) The ridge lies much nearer to the inner than the outer margin of the crescentic process, and for a part of its course follows the curvature of the former. Only a slight interval separates the anterior end of the ridge from the thickened dorsal portion of the radial nodule, the two being exactly opposite each other (figs. 3 and 20). We shall call this ridge the ventral ridge of the tripus.

The tripus is freely moveable in a lateral plane on its articulation with the complex centrum by means of the articular process, and it is evident that its anterior and crescentic processes represent the two arms of a lever, the fulcrum of which is the vertebral connection of the articular process.

We append the following measurements of the Weberian ossicles of a specimen of *Macrones nemurus* eight inches in length, but it may be remarked that the dimensions of the ossicles are liable to considerable variation according to the size of the particular example examined :—

<i>Scaphium.</i>	mm.
Length of ascending process, including the condylar process . . . . .	3
Total length of the spatulate process, including its root . . . . .	2.5
Length of the stapulate process, not including its contracted root, but only the concavo-convex portion which closes the external atrial aperture . . . . .	2
Maximum width of the spatulate process . . . . .	1
<i>Interossicular Ligament.</i>	
Length . . . . .	1.2
<i>Intercalarium.</i>	
Length of the ascending process . . . . .	4
Length of the horizontal process . . . . .	3
<i>Tripus.</i>	
Total length not including curvature of the crescentic process . . . . .	8
Length of anterior process . . . . .	4
Length of the crescentic process, not including its curvature . . . . .	4
Length of the articular process . . . . .	2
<i>Claustrum.</i>	
Length . . . . .	3.5

*The Saccus Paravertebralis.*—The free portion of the tripus, that is to say, the articular and anterior processes, with the posterior half of the interossicular ligament, and the horizontal process of the intercalarium, are situated within the cavity of a thin-walled fibrous sac—the “saccus paravertebralis” of WEBER. The sac extends from near the external atrial aperture of its side along the lateral surfaces of the centrum of the first vertebra and the anterior third of the complex centrum as far backwards as the insertion of the crescentic process of the tripus into the dorsal wall of the air-bladder, at which point its walls blend with the dorsal edge of the transverse membrane. The anterior wall of the sac is perforated by the inter-ossicular ligament as the latter process passes inwards from the anterior extremity of the tripus to its connection with the scaphium. In the Cyprinoid Fishes the cavity of the sac is in open communication anteriorly with the cranial cavity through the external atrial aperture and the foramen occipitale laterale (hypoglossal foramen). In *Macrones*, and probably in all Siluroid Fishes, on the contrary, the small size of the hypoglossal foramen, which is but sufficiently large to transmit the hypoglossal or first spinal nerve, and the complete closure of the external atrial aperture by the spatulate process of the scaphium, effectually prevent any communication between the cranial cavity and the saccus.

The cavity of the sac is occupied by a semi-gelatinous fluid, often partly oleaginous from the presence of an abundance of oil-globules, and contained within the meshes of a delicate fibrous network. The jelly-like material is nevertheless sufficiently liquid not appreciably to hamper the grosser movements of the various ossicles that are imbedded in it.

The roots of the first four pairs of spinal nerves traverse the cavity of the saccus

where also their union to form the main trunks takes place. The ganglia on the dorsal roots of the nerves are likewise contained within the sac.

*The Air-Bladder.*—On examining the external surface of the body behind the pectoral girdle and dorsad to the origin of the pectoral fin a well-defined area of skin, generally slightly wrinkled or flaccid in spirit-preserved specimens, sometimes extremely tense, but always differing in appearance from the rest of the smooth scale-less skin, may be readily recognised on each side (fig. 15, *l.c.a.*). These areas we propose to call the lateral cutaneous areas. Each area is bounded by, and more or less firmly attached to, the stem of the post-temporal and the upper portion of the clavicle in front; the posterior process of the clavicle and the free dorsal edge of the ventro-lateral muscles below; and the distal margins of the expanded transverse processes, with the first rib, above and behind. The lateral line canal crosses the upper margin of each area a little below the dorsal attachment of the latter to the modified transverse processes. On reflecting either cutaneous area the great dorso-lateral and ventro-lateral muscles of the body wall are seen to diverge at its posterior boundary, the former passing upwards and forwards over the expanded transverse processes to their insertion anteriorly into the posterior face of the skull, the latter passing downwards and forwards to their insertion into the ventral moiety of the clavicle (fig. 16). Between these divergent muscles the lateral wall of the anterior third of the air-bladder bulges outwards, and, normally, is very closely applied to the inner surface of the lateral cutaneous area of its side. The cutaneous areas are somewhat thinner than the rest of the skin, and their flaccidity, due perhaps to their greater thinness, combined with their intimate relations to the thin-walled air-bladder, renders it, as a rule, an easy matter to localize these areas without having recourse to dissection. In not a few Siluroids, as we shall subsequently have occasion to point out, in which the body is greatly compressed, and the cutaneous areas and the adjacent lateral walls of the air-bladder exceptionally thin, this part of the body appears partially translucent when the fish is held up to the light.

When the ventral wall of the body with the stomach, liver, and intestines have been removed the air-bladder comes into view as a flattish conical organ, broad in front, but somewhat narrower and more rounded behind (fig. 17, *a.b.*). The dorsal surface of the anterior third of the bladder is closely moulded to the shape of the ventral surfaces of the modified transverse processes of the fourth and fifth vertebræ, and to the keeled ventral surfaces of the complex and fifth vertebral centra, but for the posterior two-thirds of its length the bladder is much less closely related to the succeeding vertebral centra, transverse processes, and ribs, and lies comparatively free in the abdominal cavity. In front the lateral portions of the anterior wall of the air-bladder are firmly buttressed by the concave posterior faces of the bony structures formed by the post-temporal plates in conjunction with the crescentic extremities of the modified transverse processes of the fourth vertebra (figs. 3, 17, 18, *pt.p.*, *tp.<sup>4a.</sup>*). The lateral walls of the anterior third of the bladder are in close relation with the

inner surfaces of the lateral cutaneous areas, but more posteriorly the side walls contract from the external skin and the lateral musculature of the trunk, and, with the posterior wall, become closely embraced by the lateral and median posterior lobes of the mesonephros (fig. 18, *mph.*).

Immediately in front of the air-bladder, and closely moulded to the convexity of its anterior wall, the so-called head-kidney,\* consisting of two lateral lobes and a thin transversely disposed connecting lobe, may be seen through the thin peritoneal layer which invests its ventral surface. Each lateral lobe occupies a recess between the inferior limb of the post-temporal in front, and the anterior division of the transverse process of the fourth vertebra behind, with its dorsal surface in contact with the floor of the membranous sac (*saccus paravertebralis*) in which certain of the Weberian ossicles are contained (figs. 17 and 18, *mph.r.*). The connecting lobe stretches transversely across the ventral surfaces of the body of the first vertebra and the adjacent portion of the basioccipital. The anterior surface of the gland is convex, and is closely invested by a strong transversely disposed aponeurotic membrane.

The peritoneum (fig. 23, *p.*) invests only the ventral surface of the air-bladder, extending laterally on to the side walls of the abdominal cavity, but in the medio-ventral line forms an incomplete mesentery, and is subsequently reflected on to the dorsal surface of the stomach; anteriorly, it is continued forwards from the ventral surface of the bladder over the corresponding surface of the "head kidney," and, after blending with what we shall subsequently refer to as the "aponeurotic membrane," is reflected backwards on to the dorsal surface of the œsophagus. Near the antero-lateral regions of the air-bladder the peritoneum by a characteristic reduplication forms on each side a deep cæcal pouch, with a somewhat restricted communication with the general peritoneal cavity, which extends outwards towards the inner surface of the proximal half of the clavicle and the root of its posterior process. These peritoneal cul-de-sacs exist in all Siluroid Fishes, and invariably contain prolongations of the lateral lobes of the liver. Their formation appears to be due to the unusual lateral extension of the anterior third of the air-bladder and the abutment of its outer walls against the inner surfaces of the lateral cutaneous areas, the partial displacement of the lateral hepatic lobes from their normal position between the air-bladder and the side walls of the body, which this modification involves, being compensated for by the outward and forward protrusion of a portion of each lobe into special peritoneal pouches. The position and relations of these pouches as well as the recesses for the "head kidney" are shewn in *Auchenoglanis biscutatus* (fig. 44, *p.c.s.*, and *mph.r.*).

Internally to its peritoneal coat the air-bladder is partially invested by a membrane which is obvious enough where it is in relation with what, for the present, we may call the proper anterior wall of the bladder, but in most instances is extremely difficult to trace elsewhere. In the former position it exists as a thin, but fairly

\* Otherwise the anterior lymphoid expansion formed by the fusion of the right and left halves of the mesonephros.



strong, inextensible, and transversely-disposed fibrous membrane which is co-extensive with, and closely applied to, the mesial portion of the anterior wall of the bladder between the two post-temporal plates, and, although intimately applied to both, separates the bladder from the "head-kidney" in front. Laterally, on each side, the membrane is firmly attached to the ventral and inner margins of the post-temporal plate, and to the crescentic distal extremity of the transverse process of the fourth vertebra, blending with the ligamentous fibres by which these skeletal elements are rigidly connected together. The dorsal edge of the membrane is firmly attached to nearly the whole length of the anterior margins of the transverse processes in question, and towards the median line blends with the floor of each saccus paravertebralis. In the median line the dorsal margin appears to be continuous posteriorly with the fibrous floor of the aortic canal, and, on each side of the complex centrum becomes firmly attached to its oblique lateral ridge and to the radial nodule, while posteriorly a slip of fibres curves upwards and backwards to an insertion into the anterior or inner extremity of the dorsal lamina. The latter slip and the fibrous floor of the aortic canal are all that we could definitely identify as representing this membrane on the dorsal surface of the air-bladder. Traced ventrally the membrane suddenly becomes extremely thin, but, nevertheless, may be detected as extending for a short distance on to the lateral and ventral walls of the anterior portion of the air-bladder, where, however, it soon becomes lost as a definite structure, either by blending with the proper wall of the bladder, or becoming indistinguishable from the connective tissue by which the latter is connected with its peritoneal investment.

In close relation with the anterior face of the "head-kidney" there is a second transversely disposed aponeurotic membrane which occupies the same transverse plane on the dorsal side of the œsophagus as the pericardial septum on the ventral side, and is also attached laterally to the distal ends of the modified transverse processes and to the adjacent margins of the post-temporal plates, blending with the ligamentous fibres by which the transverse processes and the post-temporals are firmly united together, and also with the corresponding attachments of the first-mentioned membrane, but remains separated from the latter mesially by the "head-kidney." Ventrally, the aponeurosis blends with the peritoneum as the latter is reflected backwards from the under surface of the "head-kidney" on to the dorsal surface of the œsophagus. Dorsally, the membrane extends backwards as an investment to the dorsal surface of the "head-kidney" and the ventral faces of the basioccipital, the inferior limb of the post-temporal, and the body of the first vertebra, finally becoming inserted into the anterior margins of the modified transverse processes of the fourth vertebra, and there to some extent blends with the similarly attached dorsal edge of the preceding membrane. The aponeurotic membrane has clearly no relation to the air-bladder, but may be regarded simply as a dorsal and backward extension of the same fibrous sheet which, ventrally, separates the pericardial and abdominal cavities.

With regard to the first-mentioned of the two membranes it is not easy to decide

in what light it should be regarded. In some respects it resembles a backward extension of the aponeurotic membrane. RAMSAY WRIGHT (43) in his description of the skeletal attachments of the anterior part of the air-bladder in *Amiurus catus*, evidently regards it as a portion of the proper anterior wall; at all events he describes the dorsal wall of the anterior chamber as being anteriorly attached to an oblique ridge on each side of the complex centrum, and to the thickened anterior margin of the transverse process of the fourth vertebra, and the only portion of the air-bladder that answers to this description is the transversely-disposed membrane in connection with the proper anterior wall. MCKENZIE (23) refers to it as an aponeurotic membrane separating the "head-kidney" from the air-bladder. On the other hand, we have but little doubt that the membrane described by SÖRENSEN (37) as more or less completely investing the air-bladder in certain Siluroids, and often becoming much thicker anteriorly than elsewhere, is identical with the one now under discussion. SÖRENSEN, however, apparently regards the membrane as constituting an inner layer of the peritoneal coat, although from his account it would seem to furnish a much more complete investment to the bladder than the outer layer, which carries the cœlomic epithelium, and is restricted solely to the ventral surface. For our own part we incline to the opinion that the membrane in question owes its existence as a definite structure to a delamination of the proper anterior wall of the air-bladder, which has also affected, but less obviously, the adjacent lateral, ventral, and dorsal walls, and ought, therefore, to be regarded as an integral portion of that organ. It is also more closely adherent to the proper wall of the air-bladder than to the investing peritoneum, and in some Siluridæ is much more obvious than in others, being traceable for a greater distance on to the lateral and ventral walls. In *Arius* and some other Siluridæ, in addition to the membrane now under consideration, which is also present, a second layer, anatomically and histologically undoubtedly a portion of the anterior wall of the bladder, may separate dorsally from the inner portion of the wall, and acquire skeletal attachments similar in almost every respect to those of the former. It is perhaps a matter of no great importance which view be taken, but from a physiological point of view the membrane is of some interest, inasmuch as its extensive attachments to rigid portions of the axial skeleton render it an efficient and unyielding buttress to the proper anterior wall of the bladder. As we shall frequently have occasion to refer to the extension of ossified deposit from adjacent skeletal structures into this membrane, more especially in the Siluridæ abnormales, we shall in future refer to it as the "superficial coat" of the air-bladder, distinguishing, however, that portion of it which specially buttresses the proper anterior wall as the "transverse membrane."

After the removal of its ventral wall the cavity of the air-bladder is seen to be divided by a characteristic T-shaped arrangement of two principal internal septa, one of which is transverse and the other longitudinal, into three main compartments. Of these compartments one is anterior and transversely disposed, and the other two

lateral or posterior in position, and longitudinally arranged (fig. 18). The anterior chamber (*a.c.*) forms about one-third, and the two lateral chambers (*l.c.*) the remaining two-thirds of the antero-posterior extent of the bladder. The transverse septum (*t.s.*) is much the thicker of the two principal septa and divides the anterior chamber from the two lateral compartments, which, in turn, are separated from each other by the median longitudinal septum (*l.s.*). The longitudinal septum is continuous in front with the posterior face of the transverse septum, and both are continuous by their dorsal and ventral edges with the corresponding walls of the air-bladder. The transverse septum is not quite vertical, but inclines forwards from its dorsal to its ventral margin, the latter being more anteriorly situated than the former, but this statement more especially applies to the mesial portion of the septum. Hence, as in fig. 18, the transverse septum has its ventral margin somewhat V-shaped, with the apex pointing forwards, while the obliquity of the septum causes the two lateral compartments to slightly overlap the anterior chamber when viewed from the ventral surface. Along its ventral edge the transverse septum is almost co-extensive with width of the air-bladder, but dorsally the septum contracts from the lateral walls, so as to leave on each side an arch-like opening through which the anterior chamber communicates with each of the two lateral compartments. There is no communication between the lateral chambers except indirectly through the anterior chamber. In addition to the principal transverse and longitudinal septa there are three or four secondary transverse septa in each of the lateral compartments, which gradually diminish in width from before backwards (fig. 18, *t.s.*). Each secondary septum, like the principal transverse septum, is of greater width dorsally than it is ventrally, and stretches from the longitudinal septum outwards towards the lateral or outer wall of the compartment, but before arriving at that point terminates in a deeply concave arch-like free margin. Dorsally as well as ventrally, the secondary septa are continuous with the corresponding walls of their respective compartments, and round their free margins the smaller cavities into which they subdivide each lateral chamber communicate with one another and with the anterior chamber. The principal transverse septum is really but the most anterior of these septa, although it differs from them in several important particulars, and notably in the firm attachment of its dorsal edge to the skeleton. In addition to the septa already mentioned, numerous buttress-like ridges of fibres arise from the dorsal and ventral margins of the longitudinal and the primary and secondary transverse septa and extend, root-like, into the adjacent roof and floor of the lateral compartments, thus still further adding to the sacculated or camerated structure of these chambers. With the exception of a few fibrous ridges that pass from the ventral margin of the anterior face of the primary transverse septum and blend with the adjacent ventral wall of the anterior chamber, the latter has perfectly smooth walls and is entirely devoid of ridges, sacculations, or septa.

The ductus pneumaticus (fig. 17, *d.p.*) communicates with the cavity of the anterior chamber by an opening situated in the median line of the ventral wall and close to

the ventral edge of the primary transverse septum. The duct is not straight but somewhat sigmoid, with secondary flexions near its junction with the œsophagus.

As we have previously pointed out, the dorsal wall of the anterior chamber is closely related to the under surfaces of the expanded transverse processes of the fourth and fifth vertebræ, and also to the subvertebral keel which the complex and fifth vertebral centra, with their investing superficial ossifications, combine to form (fig. 23, *a.b.*). In fact the median portion of the dorsal wall, as far posteriorly as the primary transverse septum, is deeply grooved externally by the impression of the subvertebral keel, and this inpushing of the dorsal wall, which is visible internally as a prominent medio-dorsal ridge, to some extent constricts the anterior chamber into two laterally bulging halves, while the vertex of the  $\Lambda$ -shaped transverse septum has the effect of continuing this constriction into the posterior wall of the chamber (figs. 18 and 23). On the other hand, the lateral compartments lie comparatively free in the abdominal cavity, or at all events are only related laterally and dorsally to the musculature of the body wall, the slender transverse processes and ribs, and to the mesonephros, but in no way are they attached to, or protected by, any special outgrowths or modifications of the skeleton as is the case with the anterior chamber.

The dorsal anterior and posterior walls of the anterior chamber are not only more or less intimately related to certain characteristic modifications of the axial skeleton but they are directly attached thereto at certain special points. But before referring to the skeletal attachments of the anterior chamber we may, with advantage, briefly describe the general arrangement of the principal sheets of fibres that form the walls of the air-bladder. Omitting the peritoneal investment on its ventral surface, and its superficial coat, the walls of the air-bladder are composed, as in all other Teleostei, of two principal layers of fibres, viz. :—the tunica interna and the tunica externa. The former consists of an extremely thin fibrous layer, supporting on its inner surface an epithelium of flattened cells, and furnishes a complete and continuous inner lining to the various primary and secondary cavities of the air-bladder, of uniform structure and thickness throughout. In specimens that have been preserved for any length of time in spirit, or have undergone maceration for a shorter period, the tunica interna readily separates from the tunica externa. In all the figures of the interior of the air-bladder which illustrate this paper the tunica interna has been removed so as to show the disposition and skeletal attachments of the fibres composing the outer tunic. After the removal of the inner tunic, and the exposure of the tunica externa, the free edge of the oblique ventral ridge of tripus, and the ventral surfaces of the heel-like process and of the posterior portion of the crescentic process of that ossicle, are clearly distinguishable on each side of the air-bladder, imbedded in the dorsal wall of the anterior chamber near its anterior extremity and a little to the outer side of the complex centrum (figs. 18 to 20). The tunica externa is always much thicker and consequently more rigid than the tunica interna ; it is, in fact, entirely owing to the thickness and strength of the former coat, combined with its more or less extensive

attachments to the skeleton, that the air-bladder never collapses, even after its walls have been perforated, or portions removed, but invariably retains its normal shape and outline.

The tunica externa consists of two principal strata of fibres, an outer in which the general direction of the fibres is in the main longitudinal without being constant for all parts of their course; and an inner stratum composed of fibres with a general tendency to a transverse arrangement. The fibres composing either stratum, although they may vary their course and direction in different portions of the air-bladder, from longitudinal becoming oblique or nearly transverse, and *vice versa*, and may describe various curves, very rarely coincide in direction at any one point, the fibres of one stratum crossing those of the other at more or less of a right angle. This characteristic arrangement is always fairly obvious in the anterior, lateral, and dorsal walls of the anterior chamber, and in the dorsal and lateral walls of the lateral compartments, where the two strata can be readily separated and the component fibres traced, but becomes more obscure in the ventral wall; there the fibres of the outer stratum pursue a somewhat irregular course and betray a tendency to interlace with one another, so as to be only traceable with some difficulty. As a rule it is only when the two strata approach their common attachments to rigid or moveable parts of the skeleton that their respective fibres exhibit a tendency to coincide in direction. In the walls of the lateral compartments, at all events in so far as the dorsal and ventral walls are concerned, the fundamental disposition of their fibres is to some extent obscured by the extension into them of the fibres composing the longitudinal septum, the primary and secondary transverse septa and their buttress-like ridges. In the septa themselves the component fibres are always vertical.

The series of semi-diagrammatic figures, 19–22 inclusive, are intended to illustrate the arrangement and skeletal attachments of the physiologically more important fibres of the outer and inner strata of the dorsal wall of the anterior chamber as seen from the interior, and also to some extent the corresponding features of the anterior, posterior, and lateral walls. In all cases it may be presumed that the ventral wall of the bladder and the whole of the tunica interna have been removed. In figs. 19 and 20, the inner stratum of the tunica externa is shown on the right side, and the fibres forming the outer stratum on the left side. In figs. 21 and 22 the insertions of the fibres of the outer and inner strata, respectively, into the crescentic processes of the tripodes are represented.

The disposition of the principal sheets of fibres in the tunica externa of the anterior chamber and their respective attachments to fixed or moveable portions of the skeleton are as follows:—

(1.) *Attachments to rigid portions of the skeleton.*

(a.) The posterior wall of the chamber, that is, the primary transverse septum, is composed of two vertically arranged strata of fibres, a posterior thin stratum, which dorsally and ventrally is continued into the dorsal and ventral walls respectively of the two lateral compartments, and a much thicker anterior stratum. Traced dorsally

the component fibres of the latter stratum separate on the ventral face of the fifth vertebral centrum into two thick diverging sheets which pass dorsally, one on each side of the centrum, and, at the same time, curve slightly forwards into the dorsal wall of the anterior chamber; eventually, after separating from the rest of the dorsal wall, the fibres of each sheet become firmly inserted, from the median line outwards, into the ventral surface and obliquely along the sides of the centrum in question, and into the ventral surface of the transverse process of the fourth vertebra (figs. 19-20, *p.p.*). The line of attachment of each sheet coincides with the ridge-like dorsal margin of each superficial ossification and the posterior margin of the dorsal lamina, which, as we have previously described, form by their convergence anteriorly a characteristic  $\Lambda$ -shaped ridge (fig. 3). As these divergent sheets of fibres firmly attach the whole extent of the dorsal margin of the posterior wall to the axial skeleton, and physiologically must have the effect of preventing any distension or contraction of the anterior chamber in the posterior direction, they may not inaptly be termed its "posterior pillars."

(*b.*) If the fibres of the anterior layer of the transverse septum which form the posterior pillars by their dorsal attachment to the skeleton are traced ventrally instead of dorsally, they will be found to curve forwards into the ventral wall of the anterior chamber, where they assume a direction which varies according as they are mesially or more laterally situated, and, at the same time, represent the inner stratum of the tunica externa of this region. The more mesial fibres pursue a straight course forwards in the median line of the ventral wall, and ultimately curve upwards into the mesial portion of the anterior wall, where they form a vertically disposed stratum of fibres, and also blend with the corresponding portion of the outer stratum of the tunica externa, the fibres of which are also more or less vertically arranged. Beneath the anterior third of the complex centrum the confluent mesial portions of the two strata split into two slightly divergent bundles of fibres, which pass dorsally, one on each side of the centrum, to the ventral surface and sides of which, and to the radial nodules, they become closely adherent, leaving, however, a slip of fibres from each bundle to be continued dorsally to an insertion into the ventral ridge of the tripus (figs. 19 and 20, *a.p.*). As these bundles probably have much the same physiological significance with regard to the anterior wall that the posterior pillars bear to the posterior wall, and, by reason of their attachments to the complex centrum, render the anterior wall incapable of partaking in any enlargement or contraction of the anterior chamber, they may be designated the "anterior pillars." Their rigid skeletal attachments are not so extensive as in some other Siluridæ (*e.g.*, *Arius*), but, taken in conjunction with the transverse membrane and the post-temporal plates, they are obviously competent to prevent any forward bulging of the anterior wall. As we shall subsequently point out, the more laterally situated fibres of the inner stratum of the tunica externa of the ventral wall pursue an oblique course forwards, outwards, and upwards, and are then traceable into the antero-lateral and lateral wall of each half

of the chamber; from thence they converge in the corresponding half of the dorsal wall, in the form of a broad triangular sheet, to their ultimate attachment to the tripus. The fibres of the *outer* stratum of the tunica externa in the mesial portion of the anterior wall, if traced ventrally from the anterior pillars and their skeletal attachments, become easily separable from those of the inner stratum, and ultimately extend into the ventral wall, where they assume a direction which, in the main, is longitudinal or oblique; but this arrangement is somewhat modified by their tendency to describe curves and loops, and to become interwoven with one another. It is worthy of note that the attachments of the anterior and posterior pillars to rigid portions of the skeleton will not only render the anterior chamber inexpandible in the direction of its antero-posterior axis, but will also tend to limit, even if it does not entirely prevent, any expansion ventrally, inasmuch as the longitudinally-arranged fibres which form the inner layer of the tunica externa in the mesial portion of the ventral wall are directly continuous between the two pillars, and also share their respective skeletal attachments. In not a few Siluroids (*e.g.*, *Arius*) these longitudinal fibres are unusually strongly developed, and form either a single ridge or a pair of ridges, which project from the median line of the ventral wall into the cavity of the chamber, and anteriorly and posteriorly are directly continuous with the anterior and posterior pillars.

(c.) Over a somewhat lozenge-shaped area in the median portion of the dorsal wall of the anterior chamber, bounded in front and behind respectively by the anterior and posterior pillars, and laterally by the oblique posterior margins of the two triangular sheets which constitute the lateral portions of the dorsal wall, the tunica externa becomes so extremely thin as to allow the subvertebral keel to be readily seen through it when the tunica interna has been removed (figs. 19 and 20). Although extremely thin in this region the tunica externa is not free, but, on the contrary, is firmly adherent, like a periosteum, to the under surface and sides of the complex centrum and part of the body of the fifth vertebra, its area of attachment exactly coinciding with the extent of the superficial ossifications that invest the centra. It is scarcely necessary to mention that apart from the adhesion of the medio-dorsal portion of the anterior chamber to the skeleton, the close investment of the lateral portions of the dorsal wall by the expanded transverse processes of the fourth and fifth vertebræ must preclude all possibility of expansion or contraction in that direction.

(2.) *Attachments to moveable ossicles.*

(a.) The fibres forming both strata of the tunica externa in the lateral and antero-lateral walls of the anterior chamber converge as they pass into their respective halves of the dorsal wall towards the point a little to the outer side of the complex centrum, and there become inserted into the crescentic process of the tripus. The fibres constituting the inner stratum in these regions are vertically arranged; traced thence into the ventral wall they pass more or less obliquely backwards, and eventually are traceable into continuity with the more laterally situated of the

fibres which form the posterior pillars, and consequently have the same rigid skeletal attachments as the latter. Traced dorsally from the antero-lateral and lateral walls the fibres converge in each half of the dorsal wall towards the crescentic process of the tripus (figs. 18, 20, 21, *in.st.*). The fibres derived from each antero-lateral wall are inserted, at first into the outer margin of the ventral ridge of the tripus, and more posteriorly into the outer margin of the crescentic process and the apex of its heel-like projection. The fibres derived solely from each lateral wall have their final insertions from before backwards into the hinder margin of the heel-like process, and into the whole extent of the posterior margin of the crescentic process. From an inspection of figs. 18 and 19 it will be apparent that the convergence of these transversely or rather obliquely arranged fibres in each half of the dorsal wall to their connection with the corresponding tripus causes the greater part of the dorsal wall of the chamber to present the appearance of being formed of two broad and well-defined triangular sheets of fibres, with the apex of each sheet connected with the tripus of its side, and the broad base continued outwards into the antero-lateral and lateral walls. Reference to the same figures will also show that the oblique posterior margins of the two sheets slightly overlap the skeletal insertions of the posterior pillars into the dorsal lamina.

The fibres forming the outer stratum of the tunica externa in the lateral and antero-lateral walls (figs. 19, 20, 22, *o.st.*) if traced into the dorsal wall also converge towards the corresponding tripus, and, in so doing, form the outer of the two strata of which each triangular sheet is composed. For the latter part of their course, that is, as they approach the tripus, these fibres coincide in direction with the corresponding fibres of the inner stratum (compare figs. 19 and 20, *o.st.*, *in.st.*). Eventually their inner extremities, like the analogous fibres of the inner stratum are successively inserted from before backwards into the oblique ventral ridge, the heel-like projection, and the posterior margin of the crescentic process of the tripus (figs. 20, 22, *o.st.*). The insertion of these fibres into the different regions of the crescentic process, although practically identical with the corresponding insertions of the fibres of the inner stratum, is, of course, external to the latter. Traced outwards from either tripus the precise course which the fibres of the outer stratum pursue varies somewhat according to their points of insertion into that ossicle. The most anterior fibres, that is, those starting from the anterior end of the ventral ridge, after traversing the anterior part of the dorsal wall curve downwards into the antero-lateral wall, and finally extend into the ventral wall, where their disposition is mainly longitudinal or oblique (fig. 19). The bulk of the fibres, however, as they successively pass from the regions of the tripus already indicated, on reaching the antero-lateral and lateral walls loop backwards, and in doing so describe a characteristic curvature, the convexity of which is directed towards the ventral surface, and the concavity towards the dorsal surface, and then, as they are traced backwards, extend into the lateral, and finally into the dorsal wall of the lateral compartment of



that side (fig. 19, *o.st.*). The most posterior of the fibres, that is, those that are attached to the posterior margin of the crescentic process, describe a very similar curvature, but in this instance, in the dorsal wall itself, the convexity of the curve being directed outwards and the concavity inwards, and subsequently pass into the dorsal wall of the neighbouring lateral compartment, there becoming obliquely arranged with regard to the long axis of the chamber (fig. 19). In nearly all parts of their course the curvilinear fibres of the outer stratum cross those of the inner stratum at a greater or less angle, and only coincide with the latter in direction as they both approach their attachments to the tripodes. It is obvious that all fibres that ultimately become inserted into the moveable tripodes at one extremity of their course are at the opposite extremity absolutely or relatively fixed, either as is the case with those forming the inner stratum of the tunica externa, through their direct continuity with the posterior pillars, or, as with those forming the outer stratum, through their extension into the walls of the inexpandible posterior or lateral chambers of the air-bladder. The specialisation of the dorsal wall of the anterior chamber to form special tracts of fibres in the form of two broad and stout triangular sheets, separated from each other by a thin skeletally attached medio-dorsal area, each of which is composed of two intersecting strata of fibres, and extends outwards from its attachment to the tripus to form the lateral and antero-lateral walls, where it becomes intimately related to the inner surface of the adjacent lateral cutaneous area, is extremely characteristic not of *Macrones* only but of nearly all other normal Siluridæ.

(*b.*) That portion of the tunica externa which occupies the concavity of the crescentic process of each tripus is specialized to form a series of tightly stretched fibres connecting that process with the radial nodule. The fibres are firmly inserted into the nodular prominence at the dorsal extremity of the radial nodule, and from that point radiate outwards and are eventually attached to the inner margin of the ventral ridge and the whole extent of the inner concave edge of the crescentic process (figs. 19 to 22, *r.f.*). The prominence on the radial nodule occupies, as it were, the centre of a circle of which the crescentic process itself forms a large arc, and the fibres in question, like the radii of a circle, converge from the process to the nodule. For these fibres we would suggest the term "radial fibres." A thin layer of tunica interna invests the ventral surface of the crescentic process as well as the inner surface of the nodular prominence, but without forming any special attachment to either; the removal of the layer, which can be readily effected, at once exposes the surfaces of both ossicles.

Although, as we have previously pointed out, the typical disposition of the fibres of the two strata of the tunica externa is transverse or circular for the inner stratum and longitudinal for the outer, it is obvious that this arrangement has been widely departed from in particular portions of the bladder. Thus, while the disposition of the fibres of the inner stratum in the lateral and anterior walls of the anterior chamber

exhibits but a slight modification of the transverse arrangement, in the dorsal wall, on the contrary, the fibres become more or less oblique, and in the ventral wall oblique or even longitudinal. On the other hand, the fibres of the outer stratum, although somewhat irregular in their course, are mainly longitudinal in the ventral wall, but oblique in the dorsal and anterior walls, and curvilinear in the lateral. It is the specialization of particular tracts of fibres for the attachment of the walls of the air-bladder to fixed or moveable skeletal elements that is mainly responsible for the many marked deviations from the normal arrangement.

Broadly speaking, it may be concluded that in *Macrones* the air-bladder consists of two physiologically distinct portions, a posterior, including the two lateral compartments, which from its septate or camerated structure can have but little capacity for change of volume in the way of distension, and an anterior chamber which is obviously capable of such volumetric variations. And also that any variations in the capacity of the anterior chamber can only be produced by lateral bulging or contraction in which the anterior, posterior, dorsal, and ventral walls have no share. It may further be concluded that as the fibres of the lateral and antero-lateral walls of the chamber are directly inserted into the tripodes at one extremity while remaining actually or relatively fixed at the other, any lateral variations of its internal capacity must impart corresponding movements to the tripodes and to the remaining Weberian ossicles.

As regards the histological structure of the air-bladder we have nothing to add to MACULLUM'S description of *Amiurus* (24), which agrees substantially with that previously given by LEYDIG (22) for other Siluridæ. We can also confirm in the case of *Macrones* MACULLUM'S statement as to the absence of muscular fibres in the walls of the bladder of *Amiurus*.

In many Teleostei specially developed retia mirabilia or "vaso-ganglia," invested by a special modification of the epithelium of the tunica interna, are present, usually in the form of conspicuous flesh-coloured projections into the cavity of the air-bladder. Neither in *Macrones* nor in any other Siluroid that we examined were these structures present; and we are able to confirm MACULLUM'S statement (*loc. cit.*) that the epithelium presents no special or local modifications where it invests the capillary plexuses.

*The Relations of the Spinal Nerves to the Anterior Vertebrae and the Weberian Ossicles.*—The mode of exit of the anterior spinal nerves from the neural canal, as well as their peripheral distribution, are substantially the same as described by RAMSAY WRIGHT in the case of *Amiurus catus* (42), but on one interesting point with reference to the relations of the roots of the third spinal nerve to the intercalarium, which has an important bearing on the exact homology of that ossicle, *Macrones* differs from *Amiurus*. Owing to the absence of an ascending process in the intercalarium and the generally reduced condition of that ossicle in the latter Siluroid, RAMSAY WRIGHT was unable to satisfy himself as to its exact relations to the nerve in question, and consequently missed an important item of confirmatory evidence in support of the view originally suggested by BAUDELLOT, and subsequently adopted by

NUSBAUM, GRASSI, and himself, that the intercalarium is identical with the neural arch of the second vertebra.

The foramen for the first spinal, or "hypoglossal" nerve, traverses the exoccipital, and is seen internally just over the roof of the cavum sinus imparis (fig 5, *sp.n.*<sup>1</sup>), but externally is visible immediately in front of the external atrial aperture (figs. 1, 4, and 9, *sp.n.*<sup>1</sup>). The dorsal and ventral roots of the second and third spinal nerves traverse distinct paired foramina in the fibrous wall of the neural canal between the neural plate of the exoccipital in front and the arch of the third vertebra behind. The roots of the second nerve pass outwards between the ascending processes of the scaphium and intercalarium, the foramen for the dorsal root being situated near and a little behind the upper extremity of the scaphium, and the one for the ventral root at a much lower level (figs. 4 and 5). The foramina for the roots of the third nerve lie comparatively close together between the ascending process of the intercalarium and the arch of the third vertebra (figs. 4 and 5). The roots of the fourth spinal nerve pass outwards from the neural canal through a single foramen in the anterior part of the arch of the third vertebra (*sp.n.*<sup>4</sup>); those of the fifth nerve through a pair of foramina near the posterior margin of the arch of the fourth vertebra (*sp.n.*<sup>5</sup>); and similarly the roots of the sixth nerve through a pair of apertures in the posterior part of the arch of the next vertebra; and so on with the succeeding anterior spinal nerves (fig. 2).

As the roots of the first to the fourth spinal nerves, inclusive, emerge from the neural canal to pass to their peripheral distribution, they traverse the cavity of the saccus paravertebralis on the dorsal side of certain of the Weberian ossicles. The hypoglossal nerve crosses the interossicular ligament, and emerges from the saccus between the inferior limb of the post-temporal and the opisthotic plate of the exoccipital, and immediately behind the vagus. The second and third nerves cross the anterior process of the tripus, and leave the saccus between the inferior limb of the post-temporal and the anterior division of the transverse process of the fourth vertebra. The fourth nerve emerges from the posterior extremity of the saccus, and, after passing dorsad to the crescentic process of the tripus, is continued by its ramus ventralis along the ventral surface of the transverse process of the fourth vertebra. The rami ventrales of the two succeeding spinal nerves traverse the dorsal surfaces of the transverse processes of the fourth and fifth vertebræ respectively. As the rami ventrales of the fourth to the sixth spinal nerves, inclusive, pass to their peripheral distribution, they curve round the dorsal and lateral surfaces of the anterior chamber of the air-bladder, and, in the latter part of their course, lie on each side between the lateral cutaneous area and the lateral wall of the bladder.

The ventral divisions of the first to the fourth spinal nerves, inclusive, are distributed to the muscles of the pectoral arch and fin, and those of the fifth and sixth to the lateral musculature of the trunk.

SAGEMEHL (33) has described an additional spinal nerve as emerging from the

neural canal between the claustrum and the ascending process of the scaphium in *Silurus glanis*. On this point we can only say that after a most careful examination we have utterly failed to satisfy ourselves that any such nerve exists in *Macrones*. RAMSAY WRIGHT (44) states that he has been equally unsuccessful in detecting this nerve in *Amiurus catus*.

#### *Other Species of Macrones.*

Of the remaining species of *Macrones* recorded in the 'British Museum Catalogue,' we have examined the following :—*M. planiceps*, *M. nigriceps*, *M. gulio*, *M. tengara*, *M. Wolffii*, *M. micracanthus*, *M. Hoevenii*, and *M. aor*. We also dissected a species labelled *M. armatus*,\* but which we were unable to identify with certainty as belonging to any of the species referred to in the 'British Museum Catalogue,' or elsewhere. With the exception of the last-mentioned, the locality of which was unknown, all these species are East Indian, collectively ranging from India eastwards through Burmah, Siam, Java, Sumatra, and Borneo.

With the exception of *Macrones aor* the variations met with in the structure of the air-bladder are perhaps of no great importance, but nevertheless merit a brief reference from the fact that they illustrate the nature and extent of the modifications that may occur in the normal species of the same genus, and *Macrones* is one of the very few genera of which we have been able to examine a fairly representative series of species.

*M. planiceps* and *M. armatus* very closely resemble *M. nemurus*. The same remark applies also to *M. nigriceps*, *M. gulio*, *M. tengara*, and *M. Wolffii*, except that the lateral compartments of the air-bladder in these species have comparatively undivided cavities, there being but slight rudiments of two or three secondary transverse septa in each. The post-temporal plates may also vary slightly in the depth of their posterior concavities. In *M. micracanthus* all traces of secondary transverse septa have entirely disappeared. In *M. tengara* the lateral cutaneous areas are rendered very evident externally by circular patches of black pigment, and, as GÜNTHER (15) remarks, these ocellus-like patches are more conspicuous in young than in old specimens. In *M. Wolffii* the walls of the bladder are somewhat thicker than in any other species of *Macrones*, and the lateral compartments relatively smaller. In *M. Hoevenii* the post-temporal plates are unusually expanded, and form rounded or somewhat oval laminæ of bone, thin, brittle, and cancellous at their edges, but much thickened towards the centre of their anterior faces, where each is perforated by a tubular socket for the head of the clavicle. The posterior face of each plate is much more concave than is the case with any of the preceding species, and, as in *M. nemurus*, the concavity is still further deepened round its inner and ventral margins by the unusually long and slender crescentic portion of the transverse process of the fourth

\* This specimen was given to us by Dr. DAY.

vertebra, the two structures together forming on each side a concave bony surface, which is closely applied to the adjacent antero-lateral wall of the bladder. The latter organ is proportionally larger than in other species of the genus, but the cavities of its lateral compartments are much more broken up and sub-divided through the greater development of secondary transverse septa and their buttress-like ridges.

The modifications initiated in *M. Hoevenii* are carried to an extreme degree in *M. aor*. In this species each post-temporal plate instead of being merely concave on its posterior face, as in *M. Hoevenii*, becomes curiously bullate and goblet-shaped, with the mouth directed backwards and the much contracted stem continuous with the inferior limb (fig. 25, *pt.p.*). Although the mouth of the bulla is directed backwards, its cavity, which gradually contracts, seems to extend inwards as an excavation in the inferior limb, nearly as far as the articulation of the latter with the basioccipital. The crescentic distal extremity of the modified transverse process encircles and strengthens the ventral and inner lips of the mouth of the bulla, and is firmly attached thereto by ligament. From the antero-lateral angles of the anterior chamber of the air-bladder two caecal diverticula are given off, which are just sufficiently large to extend into and fill the cavities of the two bullæ. The diverticula are composed of both tunics of the bladder, but the tunica externa is extremely thin. With the exception of the antero-lateral cæca the walls of the air-bladder are much thicker than is usual in *Macrones*. The ventro-lateral margins of the anterior chamber are curiously thickened internally by strong rib-like aggregations of the vertical fibres of the inner stratum of the tunica externa, which separate a series of small slit-like sacculi. The cavities of the lateral compartments are partially obliterated by the excessive development of the secondary transverse septa and their buttress-like bundles of fibres, as well as by the growth of vertically disposed fibrous columns extending between their dorsal and ventral walls. Marginal bundles of fibres are also developed in connection with the lateral walls of these compartments, and extend inwards in the form of incomplete septa; the latter, with the smaller buttresses which they give off, to a large extent obliterate the lateral passages by which the compartments normally communicate in front with the anterior chamber. The lateral walls of the anterior chamber are not in direct contact with the superficial skin, the two structures being more or less completely separated by the anterior lobes of the mesonephros, but in general structure, and in the relations and attachments of its fibres to fixed or moveable portions of the skeleton, this section of the air-bladder presents no special peculiarities. The Weberian ossicles are almost precisely similar to those of *M. nemurus*. The ascending process of the intercalarium, relatively to the horizontal process, is rather stouter than usual, the latter being extremely thin and slender, and, moreover, is forked at its outer extremity where imbedded in the interossicular ligament. As in several other Siluroids, the posterior wall of the atrial cavities is strengthened by a small median process of bone, apparently derived from the posterior and dorsal margin of the basioccipital, but more probably due to the ossification of the median portion of the fibrous wall itself. The process is

grooved on its posterior face, and the groove receives the vertical ridge of fibrous tissue which imperfectly separates the two cavities.

*Bagrus bayad.*

In the structure of the air-bladder and in the general details of its osteology this African Siluroid differs in no essential respect from *Macrones nemurus*. Relatively to the size of the body the air-bladder is somewhat smaller than in the latter species, and, with the exception of a single short but stout secondary transverse septum in each of its lateral compartments, has smooth walls and undivided cavities. The walls of the bladder are moderately thick, but somewhat thinner in the lateral and antero-lateral regions than elsewhere. The tripus has no heel-like process, and the intercalarium has a well-developed ascending process in addition to a horizontal one.

*Bagrus docmac.*

In a skeleton of this species in the British Museum we noticed that the post-temporal plates were incompletely ossified, a deep cleft extending inwards from their outer margins.

*Chrysichthys macrops.*

In a skeleton of this Siluroid in the British Museum collection the anterior margin of each of the transverse processes of the fourth vertebræ was bent sharply downwards so as to form a vertical, transversely disposed plate which must have excluded the post-temporal plate from contact with the anterior wall of the air-bladder.

*Pseudobagrus brachysoma.*

In this Siluroid there are several noteworthy peculiarities of the skeleton in which it differs from most of the preceding species.

The stem and inferior limb of the post-temporal (fig. 26, *pt.s.*, *pt.i.*) are no way modified to form the post-temporal plate which is so characteristic of the various species of *Macrones* and *Bagrus*. On the contrary the stem is vertically cleft into an inner and an outer process, and the cleft with its groove-like prolongation forms an articular cavity (*cl.s.*) for the proximal extremity of the clavicle, the latter being retained in position by strong ligamentous fibres which convert the groove into a tubular socket. The transverse process of the fourth vertebra is so deeply cleft that its divergent anterior and posterior divisions (*t.p.<sup>4a.</sup>*, *t.p.<sup>4p.</sup>*) are but slightly united at their roots, and would resemble normal transverse processes but for their greater length and thickness. The posterior division (*t.p.<sup>4p.</sup>*) is directed obliquely backwards, and has its root connected by a thin lamina of bone with the corresponding portion of

the succeeding transverse process. The anterior division (*t.p.<sup>4a</sup>*) is unusually stout, with a broad flat root, which is in relation by its ventral surface with the tripus, but flattened from before backwards for the remainder of its length. It has but a slight downward curvature, and, instead of being prolonged into a crescentic distal portion, as in *Macrones*, has its thick truncated extremity firmly applied to the inner moiety of the cleft post-temporal stem in such a way as to deepen the articular groove for the clavicle by strengthening its inner margin, and at the same time entirely excludes the post-temporal from contact with any portion of the anterior wall of the air-bladder. From this arrangement it will follow that the transverse processes alone furnish the usual bony buttresses for the antero-lateral regions of the bladder, in addition to affording a firm and rigid support to the pectoral girdle. At their junction the post-temporal and transverse process are firmly united together by ligament. A transverse membrane stretches between the distal extremities of the anterior divisions of the modified transverse processes, in close relation with the proper anterior wall of the bladder, and elsewhere has the same skeletal attachments as in *Macrones*.

The air-bladder has fairly thick walls, and is subdivided in the usual way into an anterior and two lateral compartments. Relatively to the anterior chamber, the lateral compartments are somewhat larger than is usually the case, and extend backwards in the abdominal cavity as far as the origin of the seventh pair of ribs. The primary transverse septum is exceptionally narrow, and forms a stout column of vertically disposed fibres. The longitudinal septum is incomplete posteriorly, so that the two lateral chambers communicate with each other directly, as well as indirectly, through the anterior compartment. There are no secondary transverse septa, and both the anterior and lateral compartments have smooth non-sacculated walls. In all other points the air-bladder closely resembles that of *Macrones nemurus*.

The outer surface of each lateral cutaneous area is rendered very conspicuous by a large circular patch of black pigment, surrounded by a white margin.

The Weberian ossicles are also very similar to those of *Macrones*; the tripus, however, has no heel-like process. The relative lengths of the anterior and crescentic processes of this ossicle are 8 mm. and 6 mm. respectively, instead of being approximately equal.

The posterior wall of the atria sinus imparis is strengthened by a spicular upgrowth from the dorsal margin of the hinder face of the basioccipital, as in *Macrones aor*.

#### *Pseudobagrus fulvi-draco*.

The skeleton, air-bladder and Weberian ossicles of this species are precisely similar to those of *P. brachysoma*.

#### *Liocassis micropogon*.

In this and the next species (*Bagroides melanopterus*) we meet with a reversion to the *Macrones* type.

In *Liocassis* there is a well developed post-temporal plate, with a concave posterior face, and a thickened and convex anterior surface. To the ventral and inner margins of each plate the crescentic extremity of the anterior division of the transverse process of the fourth vertebra is applied, precisely as in *Macrones*. The air-bladder closely resembles that of *Pseudobagrus*, but relatively to the size of the body, is, perhaps, somewhat smaller, the reduction, however, being mainly at the expense of the lateral compartments. Both the anterior and lateral chambers have undivided cavities and perfectly smooth walls. The primary transverse septum is represented by a stout vertical column of fibres, continuous behind with the longitudinal septum, and having its dorsal margin attached to the skeleton in the usual fashion. The longitudinal septum is complete posteriorly.

The tripus has but the barest rudiment of a heel-like process, but in all other points the Weberian ossicles are in close agreement with those of the type form.

*Bagroides melanopterus.*

This species is to some extent intermediate between *Liocassis micropogon* and *Macrones Hoevenii*. In the nature of its skeletal modifications *Bagroides* closely resembles the latter, but as regards its air-bladder the agreement is with *Liocassis*; nevertheless, *Bagroides* has one or two noteworthy peculiarities of its own.

Each post-temporal plate is unusually large, and extends inwards along the lower border of the inferior limb—with which, of course, it is continuous—nearly as far as the articulation of the latter with the basioccipital. In shape the plate is a somewhat irregular oval, the long axis of which is directed from within outwards and downwards. The posterior face of the plate is deeply concave, resembling a shallow cup; its peripheral margins are extremely thin and brittle, but towards the centre of its anterior face the plate becomes greatly thickened, and is at the same place perforated by a tubular and vertically-disposed socket for the proximal end of the clavicle. The crescentic distal extremity of the modified transverse process is much shorter than in *Macrones*, but has the same relations to the ventral and inner margins of the correlated post-temporal plate as in the latter Siluroid, or, more particularly, as in *M. Hoevenii*. At the junction of the crescentic process with the much thicker root of the transverse process there is a deep groove, which is concave from above downwards, and looks forwards and a little outwards; and into this groove is received a rounded articular ridge on the posterior face of the inferior limb of the post-temporal, near the junction of the latter with the post-temporal plate. The interlocking articulation of the two structures enables the transverse process to afford an exceptionally firm support to the shoulder-girdle. The ligament described and figured in *Macrones nemurus* as passing between the transverse process and the post-temporal plate, although present in most of the species so far described, is absent in *Bagroides*.

The air-bladder is somewhat pyriform in shape, with the broad end directed for-



wards, and has thicker and more rigid walls than usual. In the smoothness of its inner surface, and in the total absence of all trace of secondary transverse septa, as well as in the narrow column-like shape of the primary transverse septum, the air-bladder very closely resembles that of *Liocassis*. A short tubular cæcum is attached to the posterior end of the bladder, and has its cavity subdivided into two lateral canals by a corresponding backward prolongation of the longitudinal septum, which separates the two lateral compartments anteriorly. The two canals are distinct from each other, but communicate with their respective lateral chambers in front. In the general structure of the walls of the anterior chamber, and in the relations and attachments of their principal sheets of fibres to fixed parts of the skeleton and to the tripodes, *Bagroides* exhibits no perceptible difference from *Macrones*. We have described the walls of the air-bladder as being thicker and more rigid than usual, but this statement does not accurately apply to the antero-lateral regions of the anterior chamber, for there the walls are extremely thin over definitely circumscribed areas exactly co-extensive with the post-temporal plates. In each area the wall of the bladder appears to be formed mainly, if not exclusively, by the vertically disposed fibres of the inner stratum of the tunica externa, with the addition of the extremely thin tunica interna. Both areas bulge forwards into the concavities of their respective post-temporal plates.

The Weberian ossicles are very similar to those of *Macrones*, except that the heel-like process of the tripus is of unusual length, being, in fact, as long as the posterior or inwardly-curved segment of the crescentic process. The intercalarium has tolerably stout ascending and horizontal processes.

#### *Rita crucigera.*

This species, so remarkable for the enormous size of its pectoral and dorsal spines, which in a specimen less than twelve inches long were four and a half and three inches in length, respectively, and proportionally massive, very closely resembles *Pseudobagrus brachysoma* in most of the osteological details with which we are now concerned.

The decurved anterior division of the transverse process of the fourth vertebra is somewhat shorter than usual but very massive. Its distal half is flattened from before backwards, and, anteriorly, is firmly applied to the relatively slender inferior limb of the post-temporal, to the entire exclusion of the latter from contact with any portion of the anterior wall of the air-bladder. The distal portion of the process is not produced into a crescentic prolongation but somewhat abruptly ceases at the point where it forms the inner margin of the articular groove for the clavicle. The altogether exceptional thickness of these processes is obviously correlated with the equally exceptional development of the pectoral spines and the girdle which supports them. The superficial ossifications investing the complex and fifth vertebral centra

agree in the extent of their growth with those of *Macrones nemurus*. The oblique lateral ridges of the complex centrum are but feebly developed, and each ridge is directly continuous with the dorsal lamina of its side. The radial nodule is a short but thick ossification, firmly attached, but not ankylosed, to about the centre of the confluent lateral ridge and dorsal lamina. The stem and ascending process of the post-temporal together form a broad granulated plate which is freely exposed on the surface of the body, near the postero-lateral angle of the skull. The posterior process of the clavicle (fig. 27, *cl.p.*) is unusually long and broad, and extends backwards to about the level of the second rib; its upper margin is slightly concave, and coincides with the inferior limit of the lateral cutaneous areas of its side.

The anterior chamber of the air-bladder (fig. 27, *a.c.*) has the normal size relatively to that of the body, but the lateral compartments (*l.c.*) are very imperfectly developed, although they have the usual relations to the former, and are separated from each other by a short, stout, longitudinal septum (*l.s.*). The primary transverse septum (*t.s.*) is somewhat contracted but extremely thick, and its dorsal edge has an extensive attachment to the lateral surfaces of the centrum of the fifth vertebra and to the ventral surfaces of its transverse processes. The anterior wall of the bladder is firmly buttressed by the anterior divisions of the modified transverse processes (*t.p.<sup>4a.</sup>*), and externally to this, in the antero-lateral regions, by the concave inner surfaces of the clavicle and its posterior process. Apparently by way of compensation for the small size of the lateral chambers, two comparatively thin-walled cæcal diverticula are given off from the postero-lateral regions of the anterior chamber, which extend backwards, one on each side of the abdominal cavity nearly as far as the anus (fig. 27, *c.dv.*). These diverticula are simple cæca, tubular in shape, and of fairly uniform calibre throughout, but communicating with the anterior chamber by wide funnel-shaped mouths, situated at the outer side of the apertures whereby the same compartment opens into the two rudimentary lateral chambers. The cavities of the cæca are simple and undivided. In a brief reference to the air-bladder of this species, DAY (9) describes the right cæcal diverticulum as usually passing over to the left side, and then curving across the commencement of the left one, while the latter at first passes backwards and is then sometimes curved on itself, but in the only specimen at our disposal the cæca pursued a fairly straight course backwards towards the anus, and finally bent slightly inwards towards each other. With the exception of these cæcal outgrowths the walls of the air-bladder are exceptionally thick, but nevertheless retain their normal attachments both to fixed portions of the skeleton and to the moveable tripodes. It will be noticed, however, that the dorsal attachments of the lateral portions of the primary transverse septum are to the ventral surfaces of the transverse processes of the fifth vertebra, instead of, as in *Macrones*, to those of the fourth vertebra, and it is apparently due to the backward shifting of these attachments that the posterior pillars lose their direct insertion into the posterior margins of the dorsal laminae.

Of the Weberian ossicles, the tripus and the scaphium are for the most part perfectly normal; the intercalarium, however, has neither ascending nor horizontal processes, and, in fact, is represented only by a small nodule of bone imbedded in the middle of the interossicular ligament. The tripus (*tr.c.*) has no heel-like process, and its anterior extremity is somewhat thickened for the attachment of the stout interossicular ligament. In correlation with the exceptional thickness of the walls of the air-bladder the crescentic process, and its ventral ridge, are more stoutly developed than in most of the preceding types.

*Akysis variegatus.*

We have only been able to examine solitary examples of the two rare species, *Akysis variegatus* and *Acrochordonichthys pleurostigma*, and it unfortunately happened that both specimens were too badly preserved to admit of our results being otherwise than incomplete. We regret this the more because it is obvious that in these species both the air-bladder and the skeleton, and especially the former, differ considerably from the more normal types of those structures that we have so far described. As our specimen of *Akysis* was slightly the better preserved of the two, we shall deal with it first.

The centrum of the first vertebra is a thin discoidal bone completely excluded from view on the ventral surface by the forward extension of the superficial ossifications. The complex and fifth vertebræ are rigidly connected together, and as firmly united to the skull by the superficial ossifications, which not only invest the lateral surfaces of their centra, but also extend forwards on to the ventral surface of the body of the first vertebra, and even slightly overlap the basioccipital. The sixth vertebra is quite free, and its transverse processes carry the first pair of ribs. The spine of the third vertebra is represented by a thin lamina of bone, the dorsal margin of which slopes downwards towards the skull, and articulates by a serrated suture with a descending process derived from the supraoccipital spine. The spinous process of the fourth vertebra is exceptionally massive, and cleft distally for the support of the first two interspinous bones of the dorsal fin. The transverse process of the fourth vertebra is not only greatly expanded, but its anterior and posterior margins are somewhat decurved so as to form the anterior and posterior boundaries of a shallow concave recess on the ventral side of the process (fig. 29, *t.p.*<sup>4</sup>). The anterior margin is much thicker and more strongly decurved than the posterior, especially towards its outer extremity, where, in addition, it curves slightly backwards. The remainder of the process is comparatively thin and somewhat triangular in shape, with the apex directed outwards. The decurved anterior portion, and the thin triangular lamina respectively represent the usual anterior and posterior divisions into which this transverse process is normally divided. The corresponding process of the fifth vertebra is more strongly developed than its successors, with a slight forward inclination and a

pointed distal extremity, but confluent at its broad base with the root of the preceding process (*t.p.* 5).

Superficial ossifications greatly thicken the ventro-lateral margins of the complex and fifth vertebral centra, and there form well-marked longitudinal ridges; they are also produced ventrally and enclose between them a fairly conspicuous groove for the dorsal aorta (fig. 29, *a.g.*). Near the hinder extremity of the complex centrum each longitudinal ridge is produced slightly outwards into a short triangular process (fig. 29), which is clearly a rudimentary representative of the very similar, but much more pronounced ventral process of *Bagarius* and *Glyptosternum*, and, like the latter, has its origin from a ridge-like thickening of the superficial ossification. We could detect no trace of an oblique lateral ridge in connection with the complex centrum, but a dorsal lamina is on each side represented by a thin slender spicule of bone which becomes detached from the ventral surface of the modified transverse process at a point a little behind, and to the inner side of, the distant extremity of the crescentic process of the tripus, and, after passing downwards, inwards, and a little forwards, ventrad to the cardinal groove, terminates in a free extremity close to the lateral surface of the complex centrum, or rather is connected with the latter by a fibrous extension only (fig. 29, *d.l.*). The groove for the posterior cardinal vein is very evident on the right side, between the thickened ventro-lateral edges of the complex and fifth centra and the ventral surfaces of the roots of the contiguous transverse processes. In the region of the dorsal lamina, it is obvious that, as usual, the groove is almost completely encircled by bone. On the left side the groove is inconspicuous.

The ascending process, and the stem of the post-temporal (*p.t.*) together form an expanded plate of bone at each of the postero-lateral angles of the skull, which covers the epiotic and articulates in the usual way with the pterotic in front, and the supra-occipital above. The inferior limb (*pt. i.*) is very slender, and has but a slight forward inclination as it passes inwards to join the basioccipital (*b.o.*). Its outer extremity firmly articulates with the recurved distal end of the anterior division of the modified transverse process, and the two, in conjunction with the inner surface of the post-temporal stem, combine to form a deep articular groove for the proximal extremity of the clavicle (*cl.*).

The air-bladder is represented by two laterally-situated and somewhat ovoid, thin-walled sacs, each of which occupies the concavity of the bony recess, formed by the modified transverse process of its side\* (fig. 30, *a.s.*). There is no trace of lateral compartments, or of any connection between the two sacs otherwise than by a thin solid stratum of fibres, which extends transversely between the two, and in the median line is firmly adherent to the ventral surface of the complex centrum; neither could we detect any trace of a ductus pneumaticus. The anterior and

\* In a specimen three and a half inches in length, each air-sac was 3.5 mm. long and 2.7 mm. in width.

posterior walls of each sac seemed to be closely attached to the corresponding margins of the bony recess, in which the sac itself is partially enclosed, while the inner wall is similarly adherent to the lateral surface of the complex centrum, to the triangular ventral process, and to the dorsal lamina. The rigid skeletal attachments of the two air-sacs are substantially similar to those of the similarly modified air-bladders of *Bagarius* and *Glyptosternum*, and, probably, as we shall point out more particularly in our description of the last-mentioned genus, are capable of strict comparison with the attachments of a normal anterior chamber, or, at least, present only such differences as are necessitated by the constriction of the bladder into two distinct lateral divisions. Although obvious enough elsewhere, we could detect no definite disposition of fibres in the dorsal wall of either of the two air-sacs, neither could we trace the usual convergence of fibres from the antero-lateral and outer walls towards the crescentic process of the tripus; in fact the dorsal wall of both sacs appeared to be represented solely by an extremely thin stratum of connective tissue. We are inclined to regard this stratum as belonging to the inner tunic, the tunica externa of the dorsal wall having completely atrophied. We were unable to discover any trace of an investing epithelium, but failure in this respect was probably due to the ill-preserved condition of the specimen. It is, of course, possible that the apparent degeneration of the proper fibrous portion of the dorsal wall may also be the result of the same cause, but from the undoubted existence of similar structural lesions in other abnormal Siluridæ we prefer, provisionally at any rate, to regard this condition as normal so far as *Akysis* is concerned.

The possibility that structural defects in the connection of the walls of the air-bladder with the tripodes might be correlated with the existence of similar retrogressive modifications in those portions of the internal ear which are specially associated with the Weberian mechanism, induced us to make a careful examination of the cavum sinus imparis and its contents. The cavum itself and its atrial diverticula appeared to be perfectly normal, but relatively small in point of size. A ductus endolymphaticus was present, but of a sinus endolymphaticus we could find no trace whatever. How far our inability to discover the latter structure was due to the condition of the specimen, or to its real absence, we are unable to say, but while admitting the possibility of the former alternative, we must point out that the latter receives some support from the almost certain suppression of the sinus in other and in many respects similarly abnormal Siluridæ.

Of the Weberian ossicles the scaphium has no ascending process, but is otherwise normal; its condyle is at the hinder extremity of the spatulate process, which, anteriorly, has the usual relations to the external atrial aperture of its side. The intercalarium is reduced to a very small nodule, imbedded in the interossicular ligament, having lost both its ascending and horizontal processes. We could find no trace of claustra. The tripus is a triradiate and very slender ossicle (fig. 29, *tr.*). The anterior process is directed forwards and a little inwards as it passes to its

connection with the scaphium; the crescentic process, on the contrary, is directed backwards and slightly outwards, and, instead of curving inwards towards the complex centrum, remains in a straight line with the anterior process, and rapidly tapers to an acutely pointed distal extremity. At the junction of the two processes, and on the inner side of the ossicle, a long and slender articular process is given off, which also tapers to a point and ultimately fits into a deep pit on the lateral surface of the anterior portion of the complex centrum. The crescentic process of each tripus occupies the same relative position with regard to the inner portion of the degenerate dorsal wall of the corresponding air-sac that it does in each of the lateral halves of the anterior chamber of a normal air-bladder, with its inner margin directed towards the ligamentous connection of the dorsal lamina with the side of the complex centrum. The radial fibres of the tripus appear to be represented by a few scattered fibres derived from the dorsal edge of the inner wall of each air-sac and inserted into the inner margin of the crescentic process.

*Akysis Kurzii*, DAY.

DAY (9, pp. 703-4) describes a new species of *Akysis* from Pegue Yomas under this name. The air-bladder is said to be "small, in the abdominal cavity, not enclosed in bone," but the description is obviously too brief to allow of any comparison with *A. variegatus*.

*Acrochordonichthys pleurostigma*.

The only example of this interesting Javan species that we have been able to examine was about two inches in length, and, unfortunately, in an even worse state of preservation than our solitary specimen of *Akysis*. So far, however, as we were able to determine, *Acrochordonichthys* closely resembles *Akysis*, both in the condition of the air-bladder, and in the nature of the modifications which the anterior vertebræ and their processes undergo.

The transverse processes of the fourth vertebra (fig. 28, *t.p.*<sup>4</sup>) are greatly expanded and enclose on each side on their ventral surfaces shallow concave recesses, each of which is separated from its fellow of the opposite side by the somewhat compressed centrum of the complex vertebra. The anterior margin of each recess is strongly decurved, the posterior and other margins but very slightly so. The free distal extremity of the anterior margin is somewhat produced and recurved. The transverse process of the fifth vertebra (*t.p.*<sup>5</sup>) resembles those of the succeeding rib-bearing vertebræ, and forms no part of the bony recesses for the air-sacs. The lateral ridge of the complex centrum and the corresponding dorsal lamina form a feebly developed but continuous ridge extending along the side of the centrum obliquely upwards, backwards, and outwards towards the ventral surface of the root of the modified transverse process. We could find no trace of the usual lateral grooves for the

posterior cardinal veins, or of the ventral outgrowths from the superficial ossifications which are so conspicuous a feature in *Bagarius* and *Glyptosternum*, and to a less extent in *Akysis* also.

The stem and ascending process of the post-temporal are very similar to those of *Akysis*. The inner surface of the stem forms the outer boundary, and the recurved distal portion of the modified transverse process the inner and anterior walls, of the socket for the head of the clavicle (*cl.*). There is no trace of an inferior limb, in fact, this process seems, as it were, to have been crowded out by the abutment of the anterior margin of the transverse process against the posterior and opisthotic plates of the exoccipital.

The air-bladder differs in no essential feature from that of *Akysis*, and, as in the latter Siluroid, is completely constricted into two small laterally placed air-sacs, which occupy the concavities of the modified transverse processes of the fourth vertebra (fig. 30, *a.s.*)\* There is no communication between the two sacs, neither is there a ductus pneumaticus. As regards the skeletal attachments of the air-bladder, the degenerate condition of its dorsal wall, and the apparent atrophy of the sinus endolymphaticus, there is also an extremely close resemblance between the two genera, and this agreement further extends in almost every detail to the condition of the Weberian ossicles.

It must be admitted that while there are several features in connection with the air-bladder in *Acrochordonichthys* and *Akysis* which favour the belief that its structural peculiarities are due to the degeneration of an originally normal bladder, our results are not quite conclusive on this point. Mere reduction in the size of the air-bladder is obviously not sufficient to prove the uselessness of its connection with the auditory organ through the Weberian mechanism, but structural imperfections in either organ, or in the connecting ossicles, would be decisive. That the two air-sacs are distinct we have no doubt, and the total atrophy of the ductus pneumaticus seems equally certain, but more definite information as to the presence or absence of the sinus endolymphaticus, and as to the condition of the dorsal walls of the air-sacs and their relations to the tripodes, is desirable before it can be positively affirmed that the air-bladder and Weberian mechanism are physiologically useless in these genera. Our failure to find a sinus endolymphaticus may be due, as we have already pointed out, either to its absence, as we suggest, or to the imperfect preservation of our specimens, but if the former alternative be true, our tentative conclusions on other uncertain points would receive strong support, for if the physiological connection of the Weberian ossicles and the air-bladder were lost through the partial or complete atrophy of the dorsal walls of the air-sacs, it would be reasonable to anticipate the existence of similar retrogressive changes in that part of the auditory organ which is specially related to those structures. In subsequently dealing with two other abnormal Siluroids (*Bagarius* and *Glyptosternum*) we shall point out that they

\* The dimensions of each sac were : length, 2.33 mm., width, 1.5 mm.

furnish strong confirmatory evidence in support of our provisional conclusions with regard to *Acrochordonichthys* and *Akysis*.

*Olyra burmanica*, DAY.

The air-bladder in this species is said by DAY (10, p. 711) to be "large, thin, and not enclosed by bone." Brief as this description is, it may be legitimately inferred that the air-bladder is of the normal Siluroid type.

*Amiurus catus*.

RAMSAY WRIGHT (41 and 42) has described not only the condition of the anterior vertebræ in the adult, but also their development in very young examples of this species. These vertebræ are figured as seen in a ventral view and in longitudinal vertical section (42, Plate IV., figs. 7-8). Various sections, horizontal and transverse, through the cranium, auditory organ, and the anterior vertebræ of young specimens (3-4 cm. in length) are also represented (*loc. cit.*, figs. 9-15), but no figures of the air-bladder or of its various skeletal attachments are given. We have dissected several examples of the species, and can confirm the accuracy of RAMSAY WRIGHT'S account so far as the adult Fish is concerned.

Both as regards its skeletal modifications and the structure of the air-bladder, *Amiurus* exhibits a general resemblance to *Pseudobagrus brachysoma*. The two species differ, however, in certain minor features. In *Amiurus* the centrum of the first vertebra is said to be provided with a pair of rudimentary transverse processes. The transverse processes of the fourth vertebra are somewhat more expanded than in *Pseudobagrus*, and their anterior and posterior divisions are less obviously distinct. The sixth vertebral centrum is not invested by superficial ossifications, and is therefore free. As is *Pseudobagrus*, there are no post-temporal plates.

The air-bladder is normal. The primary transverse septum is wider than in *Pseudobagrus*. There are no secondary transverse septa, and unlike *Pseudobagrus*, the longitudinal septum is complete posteriorly. The skeletal attachments of the bladder are essentially similar to those of *Macrones*. RAMSAY WRIGHT (*loc. cit.*) describes the anterior wall as attached dorsally to the ventral edge of the transverse process of the fourth vertebra; this attachment, however, is really the dorsal insertion of what we have hitherto called the transverse membrane into the anterior margin of the process, and does not implicate the proper anterior wall as in *Arius* and its allies.

The scaphium is normal, but the intercalarium has neither ascending nor horizontal processes, and is represented by a small osseous nodule in the interossicular ligament. The tripus is also normal, but is without the heel-like process so characteristic of this ossicle in *Macrones*, and many of the preceding types.



## GROUP—PIMELODINA.

*Platystoma tigrinum.*

We have been able to examine two examples of this interesting South American form, one, a skeleton, about  $2\frac{1}{2}$  feet in length, now in the Zoological Museum of the Mason College, and the other a spirit-preserved specimen about 15 inches long. Our description of the skeleton applies more particularly to the larger of the two examples.

The series of rigidly interconnected anterior vertebræ includes the first, the complex and the fifth and sixth vertebræ, but the articulation of these vertebræ with the skull is of a somewhat more flexible character than is the case with most other Siluridæ. As compared with those of the normal free vertebræ which succeed them, the centra of the modified vertebræ, with the exception of that belonging to the first vertebra, are all greatly elongated, but less in girth, and more compressed than the former.

The centrum of the first vertebra (figs. 31 and 32, *v.*<sup>1</sup>) is exceptionally well developed, being nearly as large as any of the free centra, from which, however, it differs in the greater depth of its posterior concavity as compared with the shallow anterior concavity. It has no trace of transverse or of accessory articular processes. The complex centrum (*c.c.*) is greatly elongated and compressed laterally. Its anterior concavity is funnel-shaped, and the posterior almost tubular through its unusual depth. In the dry skeleton a cleft extends from the floor of the neural canal to about the centre of the anterior third of the complex centrum, and partially separates the anterior from the posterior tubular concavity (fig. 31); superiorly the cleft is continuous with a large foramen in the adjacent neural arch, through which the dorsal and ventral roots of the fourth spinal nerve emerge from the neural canal (*sp.n.*<sup>4</sup>). We can hardly doubt that this cleft results from the imperfect coalescence of the bodies of the third and fourth vertebræ, and serves to indicate the line of union of the anterior concavity of the latter with the posterior concavity of the former. Neither the basioccipital nor the complex centrum develop accessory articular processes, but remain widely separated by the well-developed body of the first vertebra. The centrum of the fifth vertebra is a trifle longer than the complex centrum, but, like the latter, is much compressed; the condition of its anterior and posterior surfaces is, however, reversed, the anterior being deep and tubular, and the latter funnel-shaped and relatively shallow (fig. 31, *v.*<sup>5</sup>). The centrum of the sixth vertebra is much shorter, although longer than the normal centra; anteriorly it is somewhat contracted, but widening behind it equals in the size the body of the seventh vertebra with which it articulates, like its predecessor it has the anterior cavity deeper than the posterior (*v.*<sup>6</sup>). The seventh vertebra (*v.*<sup>7</sup>) is normal and free. Although closely and firmly articulated together, no ankylosis takes place between the neural

arches of any of the modified anterior vertebræ (fig. 31). The spinous processes of the third and fourth vertebræ are distinct and divergent, the former being directed obliquely forwards to its connection with the exoccipitals and supraoccipital, while the latter which is much the longer inclines obliquely backwards (fig. 31, *n.s.*<sup>3</sup>, *n.s.*<sup>4</sup>). The spine of the fifth vertebra is much shorter and inclines forwards and may abut against the posterior margin of the preceding spine (*n.s.*<sup>5</sup>). The remaining spines are bifid and normal.

The transverse processes of the fourth, fifth, and sixth vertebræ are all more or less flattened and expanded, suturally articulating with one another by slightly serrated margins; their distal extremities are free, being separated by wide clefts. By the expansion and sutural union of these processes an unusually extensive wing-like lamina of bone is formed on each side of the anterior vertebræ, which is somewhat concave from before backwards and also from side to side, in conformity with the convex dorsal wall of the anterior chamber of the air-bladder (fig. 32). The transverse process of the fourth vertebra is the largest of the three, and distally is cleft into the usual anterior and posterior divisions (*t.p.*<sup>4a</sup>, *t.p.*<sup>4p</sup>). The anterior division (*t.p.*<sup>4a</sup>) is much thickened and, in addition, is slightly decurved at its free extremity so as to form a partial support to the lateral portions of the anterior wall of the bladder; anteriorly, the distal end of the process articulates by means of a roughened facet with the outer extremity of the inferior limb of the post-temporal, and also with the cleft stem of that bone, thus forming an incomplete posterior boundary to the socket for the head of the clavicle (fig. 34, *t.p.*<sup>4a</sup>). The posterior division is a broad thin horizontally disposed lamina. The transverse process of the fifth vertebra (fig. 32, *t.p.*<sup>5</sup>) is nearly as large as the preceding process, the posterior division of which it very closely resembles. The transverse process of the sixth vertebra (*t.p.*<sup>6</sup>), though more expanded than any which succeed it, is by far the smallest of the modified processes and carries the first rib (*r.*<sup>1</sup>).

A thick layer of superficial ossified deposit appears to invest the lateral and ventral surfaces of the anterior vertebral centra from the first to the sixth, inclusive, and also to extend laterally on to the adjacent ventral surfaces of the roots of all the modified transverse processes, thus converting the lateral grooves for the posterior cardinal veins into canals of exceptional length (fig. 32, *cd.c.*). Apparently as the result of the ventral growth of the ossifications round the dorsal aorta, the artery in this part of its course is completely enclosed within a bony canal (figs. 31 and 32, *a.c.*) which appears to burrow its way through the different centra, and opens anteriorly on the body of the first vertebra and posteriorly on the centrum of the sixth. The sutural lines between the modified transverse processes may be traced inwards on the superficial ossifications investing the different vertebral centra in the form of irregular wavy lines, which roughly indicate the position of the intervertebral sutures but without precisely coinciding therewith (fig. 32). The dorsal laminæ are represented on each side by a thin narrow process of bone (fig. 32, *d.l.*) which extends from the

lateral surface of the anterior third of the complex centrum obliquely outwards and upwards to blend with the ventral surface of the root of the first of the modified transverse processes. Each lamina is situated ventrad to the corresponding posterior cardinal vein and indeed forms the inferior lip of the anterior opening of the bony canal through which the vein passes. At the ventral and anterior extremity of each dorsal lamina, and but partially confluent therewith, there is a large crescent-shaped radial nodule (*r.n.*). The lateral surface of the body of the fifth vertebra is traversed by a stout ridge which, commencing near the anterior end of the centrum, extends obliquely backwards and upwards, and eventually bends directly outwards on to the ventral surface of the transverse process (fig. 32). This ridge receives the dorsal insertion of the primary transverse septum of the air-bladder.

In the skull of *Platystoma* the neural plates of the exoccipitals are undeveloped, the lateral boundaries of the transversely oval foramen magnum being formed by the concave inner margins of the posterior plates. A stout process of bone projects directly backwards from each posterior plate, and from this process one of the two great compressor muscles of the air-bladder takes its origin. The posterior wall of the atria sinus imparis is strengthened in the median line by a small vertical column of bone which extends upwards from the dorsal edge of the posterior face of the basioccipital and nearly meets the hinder margin of the roof of the cavum sinus imparis.

The air-bladder is well developed and extends backwards as far as the origin of the eighth pair of ribs (fig. 33, *a.b.*). In shape it is somewhat ovoid, being but slightly broader in front than behind. The lateral portions of its anterior wall are partially supported by the anterior divisions of the first pair of transverse processes (fig. 34, *tp.*<sup>4</sup>, *a.*); posteriorly to this the outer walls are at first in contact for a limited extent with the lateral cutaneous areas, but subsequently separate from the skin and the lateral musculature of the body wall as they contract to enclose the relatively narrower posterior section of the bladder. A remarkably strong muscle has its insertion into nearly the whole extent of each half of the ventral wall of the anterior third of the bladder, and its fibres, gradually converging as they are traced forwards, curve round the anterior wall and pass dorsally between the inferior limb of the post-temporal and the transverse process of the fourth vertebra to their origin on the posterior plate of the exoccipital a little to the outer side of the foramen magnum (fig. 33, *cp.*, *m.*). As the contraction of these muscles must necessarily lead to the forcible compression of the anterior chamber of the bladder, and possibly to the expulsion of its gaseous contents, we shall in future refer to them as the "compressor muscles." A much smaller and hitherto undescribed muscle (*t.t.*) occupies the recess on each side of the centrum of the first vertebra, between the latter and the corresponding compressor muscle. This muscle also arises from the posterior plate of the exoccipital, but its fibres pass directly backwards, and are prolonged into a long and slender tendon, which is ultimately inserted into the anterior wall of the bladder in close proximity to the attachments of the latter to each radial nodule (figs. 33, 34, *t.t.*).

Internally the bladder is divided into spacious anterior and lateral chambers by strong primary transverse and longitudinal septa (fig. 34, *ts.*, *ls.*), while each lateral compartment is also sub-divided into a series of transversely arranged inter-communicating cavities by six incomplete secondary transverse septa (fig. 34, *ts.'*). Strong root-like bundles of fibres radiate from the dorsal edges of the secondary septa into the dorsal wall of the bladder, and still further contribute to the peculiar camerated structure of that organ. The lateral portions of the primary transverse septum remain nearly vertical, but its mesial part is inclined obliquely forwards before it finally becomes continuous with the ventral wall; hence the ventral edge of the septum is somewhat V-shaped, with the apex directed forwards, while the lateral compartments and the longitudinal septum which separates them are prolonged forwards for some distance ventrad to the inclined septum and to the anterior chamber.\* The dorsal edge of the transverse septum is firmly inserted into the oblique ridges on the lateral surfaces of the centrum of the fifth vertebra, and also into their prolongations on to the ventral surfaces of the contiguous transverse processes (fig. 32).

The tunica externa of the anterior wall of the bladder is divisible into two strata, of which the outer and thicker is attached in the median line by its dorsal edge to the ventral and lateral surfaces of the anterior portion of the complex centrum, and also to the radial nodules and dorsal laminæ, but externally to this on each side the outer stratum, instead of extending into the dorsal wall and becoming connected with the corresponding tripus, separates from the inner and is inserted by its dorsal margin into the anterior edge and distal extremity of the transverse process of the fourth vertebra. In the lateral walls of the anterior chamber the fibres composing this stratum pursue the usual curvilinear course as they are traced into the dorsal wall, where they converge in the form of triangular sheets to their insertion into the convex outer margins of the crescentic processes of the tripodes (fig. 34, *tr.c.*, *o.st.*). The sheets are somewhat narrower than usual, and have a slightly concave inner margin, while the thin medio-dorsal area of the tunica externa, which invests and is attached to the ventral and lateral surfaces of the complex and fifth vertebral centra, is relatively much wider than in most other Siluroids; hence the surfaces of these centra and the roots of their transverse processes are readily seen through the thin area when the tunica interna has been removed. The inner and much thinner of the two strata of the tunica externa of the anterior wall divides in the median line beneath the complex centrum, and on each side the more mesially situated fibres are inserted dorsally into the inner margin and ventral surface of the root of the crescentic process of the tripus; laterally to this point the fibres of the inner stratum, which are vertically disposed, describe an inward curvature towards the tripus as they extend into the dorsal wall, and eventually become inserted into the convexity of its crescentic process (fig. 34, *in.st.*). From the antero-lateral and lateral walls of

\* In fig. 34 the right half of the transverse septum has been partially removed.

the anterior chamber the fibres of the same stratum may be traced into the dorsal wall, where they form a thin layer on the inner surface of the curvilinear fibres of the outer stratum but, instead of extending inwards to their usual insertion into the tripodes, thin away near the inner edges of the triangular sheets. The insertion of the tendon of each of the small extrinsic muscles of the bladder into the anterior wall of the anterior chamber exactly coincides with the position of those fibres of the inner stratum of the tunica externa, which are dorsally inserted into the inner margin of the root of the crescentic process of the tripus, and is in close contiguity with the similar insertion of the radial fibres of that ossicle. As the contraction of these muscles would probably have the effect of tightening such fibres, and, therefore, restrict the lateral movements of the tripodes, we venture to suggest for each the name of "tensor tripodis." The radial fibres of the tripus are strongly developed, but otherwise are normal.

Apart from the outer stratum of the anterior wall of the bladder, which is dorsally attached to the complex centrum, to the radial nodules and to the dorsal laminæ, as well as to the transverse processes of the fourth vertebra, we could detect no equivalent to the transverse membrane of other Siluroids. It is possible, however, that the outer stratum includes, not only a portion of the tunica externa of the anterior wall, but the transverse membrane as well; at all events, such an explanation is suggested by the fact that the outer stratum has the characteristic attachment of the transverse membrane to the dorsal laminæ, which is, apparently, never the case with any portion of the proper tunica externa in other Siluroids. All the normal Pimelodinae that we have examined resemble *Platystoma* in this respect.

A small cæcal appendage is closely attached to each of the lateral walls of the anterior chamber, and is partially overlapped by the great compressor muscle of its side (figs. 33 and 34, *al.c.*). The cavity of this curious appendage communicates with that of the anterior chamber by means of a number of slit-like apertures in the outer wall of the latter (fig. 34). Anteriorly, each cæcum separates from the wall of the bladder, and expands into a pear-shaped enlargement, which is in contact with the inner surface of the dorsal extremity of the clavicle. The cavity of the appendage is broken up into a series of intercommunicating spaces by a network of fibrous bundles, and the tunica interna is prolonged outwards from the anterior chamber through the slit-like orifices in its outer wall, so as to line the interior of the cæcum and the spaces enclosed by the fibrous network.

The claustra are well developed and lie one on each side of the foramen magnum; each ossicle is strongly curved in conformity with the shape of the aperture which it partially encircles. The scaphium has the usual shape, but its spatulate process is relatively small and greatly thickened; the ascending process is short and very slender. The intercalarium is represented by a thick nodule in the inter-ossicular ligament. The tripus also is normal in shape; its anterior process, however, is slightly longer than the crescentic process. The latter portion of the ossicle has a

well-marked oblique ridge on the ventral surface of its root, and, in the larger of our two specimens was greatly thickened in addition to having its posterior margin traversed by a deep groove for the insertion of the fibres of the dorsal wall of the anterior chamber.

Excluding *Auchenoglanis*, *Platystoma* is a fairly representative type of the more normal Pimelodinae, and for this reason a detailed account of the structure and relations of its air-bladder has been given. From this point of view the more noteworthy features in *Platystoma* are :—

(a.) The laxity of the articulation of the anterior vertebræ with the skull through the absence of accessory articular or subvertebral processes.

(b.) The presence of two pairs of extrinsic compressor and tensor tripodis muscles in connection with the air-bladder.

(c.) The absence of any definitely recognisable transverse membrane distinct from the skeletally attached outer strata of the lateral portions of the anterior wall of the bladder.

(d.) The tendency of the air-bladder to develop antero-lateral cæcal appendages.

In the extensive development of the superficial ossifications, and in the extent and character of the skeletal attachments of the anterior wall, as well as in some other minor features, *Platystoma* closely resembles the Arioid type, to which reference will subsequently be made.

#### *Platystoma fasciatum* and *P. coruscans*.

JOHANNES MÜLLER (28,\* Plate 4, figs. 8, 9) has noted the presence of antero-lateral cæcal appendages in *P. fasciatum* similar to those of *P. tigrinum*, but in *P. coruscans*, if we rightly interpret his brief description of this Siluroid, such appendages are entirely wanting. The anterior vertebræ of *P. fasciatum* have been figured and described by SÖRENSEN (37, Plate 2, figs. 13, 14) from whose account it would seem that they do not in any important respect differ from those of *P. tigrinum*.

#### *Sorubim lima*.

Under the name of *Platystoma lima*, JOHANNES MÜLLER (*loc. cit.*) briefly refers to this Siluroid as not possessing the cæcal appendages so characteristic of the anterior chamber of the air-bladder in *P. tigrinum* and *P. fasciatum*.

#### *Piramutana piramuta*.

The anterior vertebræ and their modified transverse processes in this species are very similar to the corresponding structures in *Platystoma*. As in the latter genus

\* See section entitled "Zellige Schwimmblasen bei einigen Siluroiden."

the transverse processes of the fourth and fifth vertebræ on each side combine to form an extensive wing-like outgrowth with a decurved anterior margin which closely envelopes the dorsal wall of the anterior compartment of the air-bladder, and at the same time buttresses the anterior wall (fig. 35, *t.p.*<sup>4a</sup>. and *t.p.*<sup>4p</sup>).

The air-bladder itself is more distinctly cordate than in *Platystoma*, and its walls are extremely thin (*a.b.*). The ventral wall of the anterior chamber is almost completely invested by powerful compressor muscles. A tensor tripodis is also present on each side, and has the same origin and insertion as in *Platystoma*. No antero-lateral or other cæcal appendages are present. Two rudimentary secondary transverse septa only are present in each lateral compartment (*t.s.*'). In the general structure of the walls of the anterior chamber, and in their relations and attachments to the transverse processes of the fourth vertebra and to the tripodes *Piramutana* differs in no essential respect from *Platystoma*. The lateral walls of the anterior chamber are in close and extensive contact with the lateral cutaneous areas.

*Piramutana Blochii.*

Under the name of *Pseudariodes clarias* (BLEEK.) SÖRENSEN (36) figures and describes the air-bladder of this species. His figure (*l.c.*, Plate 3, fig. 45) shows the left compressor muscle and on the right side the cavity of the bladder and its internal septa.

*Piratinga filamentosa.*

JOHANNES MÜLLER (28) has figured and described the air-bladder of this Siluroid under the name of *Pimelodus filamentosa* (LICHTENST.). The organ is said to consist of two entirely distinct flat sacs lying one behind the other and both cellular throughout. The ductus pneumaticus is connected with the anterior sac. The posterior sac is said not to contain the usual central cavity, the whole of the interior being occupied by small air-cells. Later on (p. 141) in alluding to the same species, MÜLLER says, "in which there is a second cellular air-bladder, without any union with the first, without connecting duct, and without communication with a respirable medium."

*Pimelodus maculatus.*

In this species the air-bladder differs but little from that of *Piramutana*, and the same may be said of the skeletal modifications.

The air-bladder has rather thick walls, and, in addition to the primary transverse and longitudinal septa, there is a rudiment of a single secondary transverse septum in each lateral compartment. The lateral portions of the primary transverse septum are nearly vertical, and have their dorsal margins attached to the ventral surfaces of the transverse processes of the sixth vertebra, but, as they approach the median line,

they become inclined obliquely forwards towards the ventral surface of the bladder, while their dorsal margins curve forwards parallel to each other along the sides; and eventually along the ventral surface of the fifth vertebral centrum, to which they become firmly attached. Near the anterior end of the centrum the lateral halves of the septum unite at an acute angle in the median line, and form a forwardly inclined keel projecting into the cavity of the anterior chamber, and partially subdividing it into two lateral divisions. The anterior portion of the longitudinal septum makes a slight deviation from the median line, and unites with the posterior face of the left half of the primary transverse septum; hence it is that the right lateral compartment extends forwards between the opposed faces of the converging lateral halves of the transverse septum until the latter finally unite in the median line anteriorly. These features are more or less characteristic of other species of *Pimelodus* with normal air-bladders (*vide P. ornatus*, fig. 36) and of *Piramutana*, but they are particularly well marked in *P. maculatus*.

The divergence of the dorso-lateral and ventro-lateral muscles of the trunk is so slight that scarcely any portion of the lateral walls of the anterior chamber is in contact with the external skin, and the two structures are further separated by a considerable amount of fatty tissue.

In an immature specimen of this species about 4 inches in length, the air-bladder had extremely thin walls, and its anterior chamber was in close and extensive relations with lateral cutaneous areas, which externally presented the appearance of superficial blisters of the skin. The longitudinal septum was attached in front to the right half of the primary transverse septum instead of the left, and hence the right lateral compartment was prolonged forwards on the dorsal or posterior face of the inclined septum, between its converging lateral halves.

A compressor and a tensor tripodis muscle were present in relation with each half of the anterior chamber.

#### *Pimelodus ornatus.*

In this species also the air-bladder and anterior vertebræ are essentially similar to those of *Piramutana*.

The anterior wall of the bladder (fig. 36) is somewhat emarginate in the median line, and consequently the anterior chamber presents the appearance of two sub-globose sacs continuous with each other across the median line, and with the two lateral compartments posteriorly. Relatively to its length and width, the bladder, and especially its anterior chamber, are somewhat deeper than in *Piramutana*. Its walls are extremely thin. Two pairs of secondary transverse septa (*t.s.*) are present, as also are compressor and tensor tripodis muscles.



*Pimelodus pulcher*, BOUL.

Our examples of this species formed part of the collection of Fishes made by the late Mr. CLARENCE BUCKLEY, at Canelos, in Western Ecuador, and subsequently described by Mr. G. A. BOULENGER in the 'Proc. Zool. Soc. of London,' for 1887, p. 274. As both the air-bladder and certain portions of the skeleton exhibit some interesting deviations from the normal type, a more detailed notice of this species will be given.

The first, the complex, and the fifth vertebræ are more or less rigidly connected together by the usual means, the sixth being the first that is freely moveable (fig. 39, *v.*<sup>1</sup>, *c.c.*, *v.*<sup>5</sup>, and *v.*<sup>6</sup>). The body of the first vertebra is very small. The complex centrum is nearly twice the length of the fifth centrum, and this again is somewhat larger than any that follow. The ventro-lateral edges of the complex and fifth centra are thickened by a continuous deposit of superficial bone, which, however, does not extend ventrally or laterally so as to convert the grooves for the dorsal aorta (*a.g.*) and posterior cardinal veins into complete bony canals. The cardinal grooves are rather deep and, as usual, that on the right side is more conspicuous than the left one. Radial nodules are attached to the lateral surfaces of the complex centrum, and from each nodule a slender dorsal lamina (*d.l.*) is continued obliquely backwards and upwards, ventrad to the corresponding cardinal groove, along the posterior margin of the transverse process of the fourth vertebra, with which the lamina eventually fuses.

The expanded transverse processes of the fourth vertebra (*t.p.*<sup>4</sup>) have broad flat roots, but are strongly decurved along their anterior margins and produced distally into slender recurved processes, which form the inner walls of the sockets for the clavicles; to the decurved anterior margin of each process the inferior limb of the post-temporal (*pt.i.*) is closely applied. The posterior portion of the process is nearly flat, but terminates distally in a pointed projection. The ventral surface of each transverse process will therefore form a shallow, transversely-disposed recess, which is slightly concave from before backwards, except for a short distance at its root. The transverse process of the fifth vertebra (*t.p.*<sup>5</sup>) is quite free, and much longer than the normal rib-bearing processes.

The air-bladder is partially constricted into two ovoid, laterally-situated sacs (figs. 39 and 40, *a.s.*), which occupy the concave recesses furnished by the modified transverse processes of the fourth vertebra (*t.p.*<sup>4</sup>*a.*), and are in free communication with each other through a narrow tubular portion passing from one to the other across the ventral surface of the complex centrum.\* This intermediate tubular portion is connected by a persistent ductus pneumaticus with the œsophagus. There is no trace of lateral compartments. As regards its rigid skeletal attachments and the

\* In a specimen three inches long the antero-posterior extent of each sac was 3.5 mm., and the transverse 4 mm.

relations of its component fibres to the tripus, each air-sac is strictly comparable to the lateral half of an anterior chamber in a normal bladder. The posterior wall of the intermediate tubular portion and the adjacent inner portion of the posterior wall of each sac are continuously thickened by the development of a thick mass of vertically disposed fibres (fig. 40, *p.p.*). On the ventral surface of the hinder part of the complex centrum these fibres separate into two bundles which pass dorsally one on each side of the centrum, and ultimately after curving slightly forwards become firmly inserted by their dorsal edges into the lateral surfaces of the complex centrum, and into the posterior margins of the dorsal laminae (fig. 39, *d.l.*). It is evident that these skeletally attached fibres almost precisely resemble the posterior pillars of a normal anterior chamber. In addition, the anterior wall of each air-sac is attached to the anterior margin of the modified transverse process by a superficial stratum of fibres which separates from the rest of the wall and is inserted into the process in question. More internally the same stratum is attached to the lateral surface of the complex centrum and to the corresponding dorsal lamina. The crescentic process of each tripus (fig. 40, *tr.c.*) is imbedded in the dorsal wall of the contiguous air-sac, near the antero-internal angle of the latter. The relations of the process to the principal sheets of fibres in the dorsal wall appear to be perfectly normal. Thus, the fibres constituting the inner stratum of the mesial part of the anterior wall have the usual insertion into the radial nodule and ventral surface of the tripus, but from this point outwards the fibres forming the inner stratum, as well as those of both the inner and outer strata of the lateral wall, and the outer portion of the posterior wall of each sac, extend into the dorsal wall and finally converge to their insertion into the convexity of the crescentic process (fig. 40). It will be obvious, therefore, that but for the insertion of the fibres of the inner stratum of the tunica externa of the lateral and dorsal walls of each air-sac directly into the tripus the skeletal attachments of the anterior and lateral walls are almost precisely the same as in the anterior chamber of *Platystoma* and other Pimelodinæ with normal bladders.

The most interesting feature in connection with the air-bladder of this species is, that while its small size and partial constriction into two lateral air-sacs would suggest that it represents an incipient stage in the kind of retrogressive modification of which *Bagarius* and *Glyptosternum* are extreme examples, it nevertheless retains its normal attachments both to rigid portions of the skeleton and to the tripodes, as well as the structural integrity of its walls, and the usual connection with the alimentary canal.

The ventral surfaces of the two air-sacs are invested by an unusually large mesonephros, which also extends laterally and, in conjunction with the peritoneal hepatic pouches and their contents, separates each sac from the adjacent lateral cutaneous area. The mesonephros of the right side only accompanies the corresponding posterior cardinal vein to join its anterior lymphoid portion. The latter part of

the gland occupies on each side a recess between the inferior limb of the post-temporal and the transverse process of the fourth vertebra, and is in contact dorsally with the floor of the saccus paravertebralis and continuous with its fellow by a slender connecting lobe which crosses the ventral surface of the body of the first vertebra.

A fairly stout ligament stretches transversely between the recurved distal extremities of the modified transverse processes, in contact with the proper anterior walls of the two air-sacs, but is firmly attached in the median line to the body of the first vertebra.

Neither compressor nor tensor tripodis muscles are present in this species.

The Weberian ossicles differ but little from those of the more normal species of *Pimelodinae*. The crescentic process of the tripus (fig. 41, *tr.c.*), however, has but a slight inward curvature. Claustra are present.

#### *Pimelodus sapo.*

Both in the structure of its air-bladder and in the modifications of the anterior vertebræ and their processes this species presents a singular and somewhat unexpected contrast to the more normally constituted species of the genus.

The complex, the fifth, and the sixth vertebræ are rigidly connected together by the growth of superficial ossifications and the partial anchylosis of their neural arches and spines. The centrum of the first vertebra (fig. 37, *v*<sup>1</sup>) is a comparatively thin, biconcave disc, firmly united to the anterior end of the complex centrum. The complex and fifth centra are about equal in size, and each is but a little longer than the centrum of the sixth vertebra (*c.c.*, *v*<sup>5</sup>, and *v*<sup>6</sup>). Superficial bony deposit has considerably thickened the lateral surfaces of the complex and fifth centra, and, to a slight extent, the centrum of the sixth vertebra also, so that these centra appear much wider as well as shorter than the corresponding elements in the more normal species of *Pimelodus*. By the ventral and lateral extension of this superficial ossification, the grooves for the dorsal aorta and posterior cardinal veins become converted into bony canals (*a.c.*, *cd.c.*). Immediately behind the anterior opening of the aortic canal, the ventral and lateral surfaces of the complex centrum are encircled by an obliquely disposed crescentic thickening, in the form of a ridge, which constitutes the anterior boundary of a deep but narrow groove, opening laterally on each side into the recess enclosed by the modified transverse processes of the fourth vertebra, and receiving the anterior margins of the mesial and inner lateral portions of the air-bladder. Small radial nodules are suturally attached to the lateral surfaces of the complex centrum, and each nodule is in fibrous continuity with a slender spicular dorsal lamina having the usual relations to the anterior opening of the cardinal canal and to the transverse process of the fourth vertebra.

Not only is the transverse process of the fourth vertebra (*t.p.*<sup>4</sup>) greatly expanded, but for the proximal third of its extent the anterior margin is bent downwards, and

for the distal two-thirds not only downwards but also backwards towards the posterior margin. The posterior edge of the process is also decurved, but to a somewhat less extent than the former. By these modifications each process forms the outer walls of a flask-shaped recess which is open posteriorly and distally in the dry skeleton, but closed behind by a tough fibrous membrane, and at the distal extremity by the lateral cutaneous area of its side in the fresh specimen. The recess is slightly expanded distally, somewhat contracted towards the centre, and again expanded at the root of the process into a relatively spacious cavity for the reception of the inner lateral cæcal portion of the air-bladder. The decurved anterior margin of the process articulates by means of a facet on its anterior face with the inferior limb of the post-temporal (*pt.i.*), while the distal edge of its recurved portion forms part of the inner wall of the socket for the clavicle (*cl.s.*), the outer wall being formed by the greatly elongated post-temporal stem (*pt.s.*). The recurved portion also forms the lower lip of the distal opening of the enclosed recess. The transverse process of the fifth vertebra is much larger than any of the normal processes, and for the whole extent of its anterior margin is suturally united to the preceding process (*tp.*<sup>5</sup>). The transverse process of the next vertebra (*tp.*<sup>6</sup>), which is much shorter and thicker, is widely separated from the foregoing and carries the first rib (*r.*').

As the result of its extremely degenerate condition the air-bladder is very curiously modified. It consists of a median portion (*a.b.*) which is flattened, leaf-like, and apparently solid, and of two lateral out-growths on each side. Of these out-growths the outer lateral one (*o.l.*) is also thin and solid, and, after curving forwards and inwards like a broad crescent, ultimately contracts rather abruptly into a slender tubular portion which bends upwards and inwards and ends blindly near the ventral wall of the saccus paravertebralis in the substance of the anterior lymphoid portion of mesonephros.\* The inner lateral out-growth (*in.l.*), on the contrary, is a hollow and relatively spacious cæcum, with fairly thick walls, which, after leaving the median part of the bladder, curves round the lateral surface of the complex centrum in the oblique groove to which reference has already been made, and finally enters the deep bony recess on the ventral side of the root of the modified transverse process where it slightly expands and becomes connected by its dorsal and inner walls with the tripus and the radial nodule respectively. No portion of the air-bladder extends into the distal two-thirds of either recess. At its blind anterior extremity the walls of the inner lateral cæcum are much thinner than elsewhere, but its cavity is practically distinct from that of its fellow of the opposite side. With the exceptions above mentioned, the whole of the air-bladder is apparently solid although denser externally than internally. The solidity of the organ is, however, really due to the almost complete obliteration of its original cavity by the development of a dense internal reticulum of anastomosing fibrous bundles. The median portion of the bladder, and especially the

\* It is possible that the outer lateral cæcum is a degenerate remnant of the antero-lateral cæca of other Siluridæ (e.g., *Platystoma*).

anterior part of it, is closely adherent to the ventral and lateral surfaces of the complex centrum. We could discover no trace of a ductus pneumaticus unless a slender solid fibrous cord extending from the flattened median part of the bladder to the dorsal wall of the œsophagus may be regarded as a vestige of it.

The mesonephros accompanies the right posterior cardinal vein through the cardinal canal, and at the anterior extremity of the latter expands into its usual lymphoid portion. The latter part of the gland surrounds the anterior extremity of the inner lateral cæcum, and also the tubular portion of the outer lateral diverticulum, and, in addition, extends into the contracted median part of each flask-shaped recess.

Except for its relatively small size the tripus is fairly normal (fig. 38, *tr.*). Compared with the anterior process (*tr.a.*) the crescentic section of the ossicle (*tr.c.*) is rather short, with a sharp hooked curvature. The articular process (*tr.ar.*) tapers to a point at its distal extremity. The crescentic process is imbedded in the dorsal wall of the anterior extremity of the inner lateral cæcum. The convergence of the fibres of the inner stratum of the tunica externa to their insertion into the convexity of the crescentic process is very obvious, as also is the attachment of the concavity of the same process to the radial nodule by means of radial fibres, but the disposition of the usual curvilinear fibres of the outer stratum is not so easily traceable, although there is no doubt as to their insertion into the tripus. The intercalarium is a very small bony nodule in the interossicular ligament. Except that it has no ascending process the scaphium is normal. The claustra are slender spicular ossicles in the usual position.

It need scarcely be added that there is no trace of compressor or tensor tripodis muscles.

The cavum sinus imparis and the atrial cavities are normal, but we could not with certainty satisfy ourselves as to the presence or absence of a sinus endolymphaticus.

#### *Callophysus macropterus.*

Under the name of *Pimelodus macropterus*, JOHANNES MÜLLER (28, Plate 4, fig. 7) figures and briefly describes the air-bladder of this species. The organ is said to be small, heart-shaped, and flat, and to be surrounded along its sides and at the hinder end by an elegant wreath of small blindly ending diverticula. Anteriorly, where in *Platystoma fasciatum* a single pair of cæcal appendages is present, MÜLLER found, on each side a very long, wide, blind diverticulum.

#### *Auchenoglanis biscutatus.*

With one exception (*Pimelodus platychir*), *Auchenoglanis* is the only African representative of the essentially South American group of Pimelodina, and, in so far as its air-bladder and skeleton are concerned, has but little in common with the other normal members of the group.

As regards the modifications of the anterior vertebræ and their processes, *Auchenoglanis* somewhat closely resembles *Pseudobagrus* or *Rita*. The first eight vertebræ are rigidly connected together, the ninth being the first of the flexibly articulated series. The body of the first vertebra is a thin slightly biconcave discoidal bone. The anterior face of the complex centrum (fig. 42, *c.c.*) is also discoidal with a relatively shallow concavity, but for the rest of its extent the centrum is laterally compressed, its posterior concavity being deep and almost tubular. The complex centrum is about half as long again as the centrum of the fifth vertebra. The latter (*v.*<sup>5</sup>) is similarly unsymmetrical in the relative depths of its concave surfaces, and nearly twice the length of any of the succeeding centra. Instead of the arch of the complex vertebra forming, as it almost invariably does, a continuous lamina of bone on each side of the neural canal, its anterior third is separated from the posterior two-thirds by a well-marked irregularly shaped cleft, which not only indicates the distinctness of the usually confluent arches of the third and fourth vertebræ, but also extends dorsalwards and is evident as a suture separating the large spinous process of the third from the rudimentary spine of the fourth vertebra.

A continuous deposit of superficial bone thickens the lateral surfaces of the compressed centra of the complex and fifth vertebræ, and is also continued posteriorly in the form of stout ventro-lateral ridges as far as the seventh centrum. There is a deep median aortic groove on the ventral surfaces of these centra bounded by prominent lateral ridges. The posterior cardinal vein traverses, not a canal, but a deep groove (fig. 42, *cd.g.*) on the sides of the complex and fifth centra, between the dorsal edge of the superficial ossification and the roots of the adjacent transverse processes, and only for a short distance in the region of the dorsal lamina (*d.l.*) does the vein become completely surrounded by bone. The ventral margin of the anterior face of the complex centrum is produced downwards and laterally into a somewhat fan-shaped, transversely disposed, plate of bone (*sv.p.*) which is cleft in the median line for the passage of the dorsal aorta. Two similar but smaller processes (*sv.p.*<sup>1</sup>) are developed from the corresponding margin of the body of the first vertebra and become suturally applied to, without anchylosing with, the former pair. These paired bony outgrowths may, in part, represent the accessory articular processes of the complex and fifth vertebræ, but if this be so, there can be little doubt that they have been greatly strengthened by the extension of the superficial ossifications from the complex centrum into the mesial portion of the outer stratum of the tunica externa of the anterior wall of the air-bladder.

The anterior division of the transverse process of the fourth vertebra (*t.p.*<sup>4a</sup>) is very stout, slightly decurved, and flattened antero-posteriorly towards its distal extremity, where it is applied to the expanded outer extremity of the inferior limb of the post-temporal. The posterior division is broad and flat (*t.p.*<sup>4p</sup>), continuous for the most part with the anterior division, but separated therefrom at its distal extremity by a wide cleft. The transverse process of the fifth vertebra (*t.p.*<sup>5</sup>) is both longer and

broader than any that follow, and partially confluent at its root with the preceding process. The transverse processes of the sixth vertebra carry the first pair of ribs and are quite free.

The radial nodule (*r.n.*) is a somewhat elongated ossification, loosely attached by fibrous tissue to the lateral surface of the complex centrum, and by the same means connected also with the slender dorsal lamina (*d.l.*), which, after passing beneath the posterior cardinal vein blends with the ventral surface of the transverse process of the fourth vertebra.

The air-bladder (fig. 44) has no extrinsic muscles comparable to the compressor and tensor tripodis muscles of the South American *Pimelodina*. Its walls are fairly thick, and its lateral compartments devoid of any trace of secondary transverse septa. The primary transverse septum (*t.s.*) stretches completely across the bladder, but two large circular apertures place the anterior and lateral compartments in free communication with one another. The skeletal attachments of the anterior wall are similar to those of *Platystoma*, except that the median portion of its outer stratum is firmly attached to and supported by the fan-shaped sub-vertebral processes. The attachments of the converging fibres of the antero-lateral, lateral, and dorsal walls of the anterior chamber to the tripodes are normal. Fig. 44 shows the outer stratum of the tunica externa of the anterior wall (*o.st.*), and incidentally also, the lateral peritoneal cul-de-sacs (*p.c.s.*), in which the small lateral lobes of the liver are lodged, the recesses which contained the anterior lymphoid lobes of the mesonephros (*mph.r.*), and the aponeurotic membrane bounding these recesses anteriorly and dorsally (*ap.m.*).

The Weberian ossicles require no special description. The anterior process of the tripus (fig. 43, *tr.a.*) is very broad in proportion to its length, and has its anterior extremity greatly thickened for the attachment of the stout interossicular ligament. The crescentic process (figs. 43, 44, *tr.c.*) is rather stout, with a relatively slight and somewhat open curvature, and a decurved inner extremity. The intercalarium is a stout nodule in the interossicular ligament. The scaphium has a comparatively small spatulate process.

The more noteworthy features in which *Auchenoglanis* differs from the majority of other normal *Pimelodina* are (*a*) the restricted extent of the superficial ossifications, which consequently fail to extend laterally on to the modified transverse processes, or ventrally round the dorsal aorta, so that the channels both for the dorsal aorta and the posterior cardinal veins remain as open grooves, instead of complete bony canals; (*b*) the presence of paired sub-vertebral processes for the support and attachment of the anterior wall of the bladder; (*c*) the absence of lateral caecal outgrowths, of secondary transverse septa, and of compressor or tensor tripodis muscles.

## GROUP—ARIINA.

*Arius pidada.*

As the genus *Arius*, of all the genera of Siluroid Fishes the most cosmopolitan in its geographical distribution, not only includes a considerable number of species, but is also fairly typical of several other genera in so far as the modifications of the anterior vertebræ and the structure of the air-bladder are concerned, we venture to give a detailed account of these structures in the Javan species, *Arius pidada*.

The series of rigidly interconnected anterior vertebræ includes the first, the complex, and the fifth, sixth, and seventh vertebræ, all of which are also firmly connected with the skull, partly by reason of the anchylosis of the accessory articular processes of the basioccipital and complex centrum, and partly by the extension of a pair of bony laminae between the supraoccipital and the modified transverse processes of the fourth vertebra.

Relatively to the normal centra the body of the first vertebra is very small, and though visible in the floor of the neural canal, of which its dorsal surface forms a part, is hidden ventrally by the coalescence of the accessory articular processes of the basioccipital and complex centrum; laterally, it is to a slight extent visible on the exterior, wedged in between the complex centrum and the base of the skull (figs. 45 and 46, *v.*<sup>1</sup>). The complex centrum is much elongated and has its posterior concavity deeper than the anterior (fig. 46, *c.c.*). Two pairs of nutrient foramina are visible on its ventral surface, in the roof of the aortic canal, which belong to the third and fourth vertebræ respectively (fig. 46). The body of the fifth vertebra (*v.*<sup>5</sup>) is smaller than the complex centrum which, however, it resembles in having the posterior concavity much deeper than the anterior. The sixth centrum is somewhat larger than the seventh but both are normal, except that their lateral surfaces are invested by the superficial ossifications (*v.*<sup>6</sup>, *v.*<sup>7</sup>). The eighth vertebra is normal and free (figs. 45 to 47, *v.*<sup>8</sup>).

The neural arches of all the anterior vertebræ from the complex to the seventh inclusive, are partially anchylosed together, only faint indications of sutures being observable between them (fig. 46).

The neural spines of the third and fourth vertebræ are long and stout; the former is inclined forwards over the neural canal in the region of the first vertebra, and abuts against the supraoccipital and exoccipitals, but a small amount of intercalated cartilage still persists in a cleft in its anterior margin (fig. 46, *n.s.*<sup>3</sup>); the latter, on the contrary, is directed obliquely backwards and cleft at its distal extremity, and grooved along its posterior margin for the support of the two large anterior inter-spinous bones of the dorsal fin (*n.s.*<sup>4</sup>). The spines of the four succeeding vertebræ are obsolete. The ninth vertebra has a pair of rudimentary spines and the tenth and following vertebræ large spines, which are bifid in the region of the dorsal fin (fig. 46).



A very characteristic feature in *Arius pidada*, and in all the Arioid genera and species that came under our notice, is the existence of a stout conical subvertebral process of bone which grows downwards from the ventral surfaces of the anterior portion of the complex centrum, the body of the first vertebra, and the hinder part of the basioccipital (figs. 45 to 48, *sv.p.*). All three bones apparently take part in its formation, but the basioccipital to a much greater extent than the others. The process is broad at its origin, somewhat laterally compressed for the greater part of its extent, but flattened from before backwards at its free ventral extremity. Its base is perforated by the commencement of the aortic canal. The subvertebral process is closely applied to the mesial portion of the anterior wall of the air-bladder, but, except at its distal extremity, there is no fibrous connection between the two (fig. 48, *sv.p.*). The formation of the process seems to have been due to the enormous enlargement of the accessory articular processes of the basioccipital and the centra of the first and complex vertebræ (see *Macrones*, p. 76, figs. 4 and 5), but if this be so their original paired arrangement is now completely obscured by ventral coalescence beneath the dorsal aorta. There can, however, be little doubt that the superficial ossifications by their extension into the median portion of the transverse membrane, and possibly also into that part of the aponeurotic membrane which invests the ventral surface of the basioccipital, combined with their subsequent fusion with the processes in question, have largely contributed to the growth of the subvertebral process. A somewhat intermediate condition between the ordinary accessory articular processes of *Macrones* and the subvertebral process of *Arius* and its allies is to be found in *Auchenoglanis* and one or two other genera, where the articular processes retain their usual paired arrangement, but those belonging to the complex centrum, and to a lesser extent those of the first vertebra also, obviously owe their lateral growth to an extension of bony deposit from the superficial ossifications into the outer layer of the tunica externa of the anterior wall of the air-bladder.

As in *Platystoma*, the superficial ossifications are very strongly developed (figs. 45 and 47, *so.s.*). Not only do they continuously invest the lateral surfaces of the anterior vertebræ from the complex to the seventh, inclusive, but, by their extension downwards and subsequent fusion in the medio-ventral line, they convert what is ordinarily a groove for the dorsal aorta into a complete aortic canal (figs. 46 and 47, *a.c.*). Laterally, the ossifications extend outwards from the sides of the centra and extensively invest the ventral surfaces of the transverse processes of the fourth and fifth vertebræ, and, in addition, slightly overlap the roots of the corresponding processes of the sixth and seventh vertebræ (fig. 47, *so.s.*). Anteriorly, the ossifications extends downwards towards the median line, and would seem to blend with the posterior face of the subvertebral process. At the posterior aperture of the aortic canal the confluent ossifications are deeply emarginate in the mid-ventral line. The shape of each ossification as it extends outwards from the vertebral centra to blend with the transverse processes is somewhat triangular, with the apex directed

outwards and confluent with the transverse process of the fourth vertebra (fig. 47). The oblique anterior and posterior margins of the ossifications are nearly straight, but the posterior is much the longer of the two. As in *Platystoma*, the lateral extension of the ossifications from the sides of the vertebral centra on to the contiguous transverse processes converts the cardinal grooves into complete canals, the length of which nearly coincides with that of the series of modified and rigidly articulated vertebræ, but unlike *Platystoma*, the ossifications are not traversed by wavy or other lines indicative of intervertebral sutures.

A stout radial nodule is firmly attached to each of the lateral surfaces of the complex centrum near its anterior extremity, and at the base of the subvertebral process (fig. 47, *r.n.*). A faint oblique lateral ridge traverses each of the anterolateral margins of the subvertebral process but scarcely reaches the radial nodule. The dorsal lamina (fig. 47, *d.l.*) is represented by a thin slender process of bone, which is prolonged from the radial nodule obliquely backwards and upwards, ventrad to the posterior cardinal vein, and finally blends with the ventral surface of the transverse process of the fourth vertebra. The posterior margin of the lamina is sutureally joined to the anterior margin of the superficial ossification of the same side, and, consequently, to a slight extent, lengthens the corresponding cardinal canal.

The presence of transverse processes in connection with the centrum of the first vertebra is very exceptional in the Siluridæ. RAMSAY WRIGHT (42), however, has described a pair of very rudimentary processes in *Amiurus catus*, and a pair of short spicular outgrowths from the first vertebra in *Arius pidada* may possibly have a like significance, but that they correspond to those carried by the succeeding vertebræ is, to say the least, very doubtful. The transverse processes of the fourth vertebra are greatly developed. Each is somewhat fan-shaped, with a flattened and contracted root, and an expanded distal portion (figs. 45 and 47, *t.p.*<sup>4</sup>). The anterior portion, representing the anterior division of the process (*t.p.*<sup>4a</sup>), is slightly thickened and strongly decurved, and, moreover, is produced distally into a pointed process which is applied to the cleft stem of the post-temporal so as to form, completely or partially, the posterior boundary of the socket for the clavicle. The posterior portion of the transverse process, which is much thickened, inclines obliquely backwards as well as outwards, and represents the usual posterior division of the process (*t.p.*<sup>4p</sup>). An extremely thin, curved, and apparently somewhat flexible lamina of bone extends between and connects the thickened anterior and posterior divisions. The relative thinness of this lamina, combined with the existence of a deep notch between the decurved anterior division and the complex centrum for the reception of the posterior section of the tripus, renders the anterior division slightly flexible and apparently capable of a limited amount of motion in an upward and forward direction. The transverse process of the fifth vertebra (*t.p.*<sup>5</sup>) is much smaller but longer and more expanded than any that follow. Its distal extremity is free, but for the greater part

of its extent the anterior margin of the process is suturally united to the posterior edge of the preceding process. The transverse process of the sixth vertebra (*t.p.*<sup>6</sup>) is long and slender, free distally, but slightly overlapped proximally by the posterior edge of its predecessor. Its distal extremity carries the first rib (*r.*<sup>1</sup>).

The expanded and otherwise modified transverse processes of the fourth, fifth, and sixth vertebræ, together with the superficial ossifications, form on each side a smooth, bony surface, concave from before backwards, and closely moulded to the convexity of the anterior and dorsal walls of the anterior compartment of the air-bladder. The strong development of the superficial ossifications and their median and ventral coalescence to form an aortic canal renders the subvertebral keel unusually prominent, and its groove-like impression in the medio-dorsal line of the anterior chamber exceptionally deep.

Except for the large size of the accessory articular processes of the basioccipital and their union with those of the complex centrum to form the subvertebral process, the structure of the hinder part of the skull substantially agrees with that of *Macrones*. The cranial recesses for the utriculi are unusually spacious, and are visible externally as prominent rounded bullæ on the surfaces of the auditory capsules near the postero-lateral angles of the skull. The cavum sinus imparis (fig. 46, *c.s.i.*) contracts towards its hinder extremity and communicates with the two atria by a comparatively small aperture. The posterior edge of its roof is produced downwards into a median process, which nearly meets the slightly upturned posterior margin of the basioccipital and strengthens the otherwise fibrous roof and posterior wall of the atrial cavities. The posterior face of the skull is firmly united to the anterior vertebræ by two broad shelving plates of bone which extend downwards from the lateral portions of the supraoccipital and suturally articulate with stout ridges on the dorsal surfaces of the transverse processes of the fourth vertebra (figs. 45, 46, *so.*<sup>2</sup>). The supraoccipital spine (*so.*<sup>1</sup>) is very strongly developed and extends backwards over the interspace between the divergent spines of the third and fourth vertebræ to its sutural union with the first interspinous bone or nuchal plate (*i.s.*). A thin lamina of bone is given off from the posterior plate of the exoccipital between the two foramina for the passage of the pneumogastric and hypoglossal nerves, and extends backwards towards the root of the first of the modified transverse processes; this plate forms the outer wall of a recess in which the saccus paravertebralis is lodged, the inner wall being formed by the adjacent lateral surfaces of the first vertebral centrum and the anterior portion of the complex centrum (fig. 47).

It will be observed that the union of the skull with the anterior vertebræ is unusually intimate in *Arius*. Apart from the partial ankylosis of the accessory articular processes of the basioccipital and complex centrum in the formation of the characteristic subvertebral process, the union of the paired supraoccipital laminæ and the median supraoccipital spine with the transverse processes of the fourth vertebra

and the expanded first interspinous bone, respectively, renders the connection between the two structures exceptionally rigid.

The post-temporal is normal in shape, and in its relations to the skull and to the transverse processes of the fourth vertebra. The inferior limb of the bone articulates with a stout projection from the lateral surface of the basioccipital (fig. 47, *pt.i.*). The cleft in the stem of the post-temporal to form the clavicular socket is unusually deep (*cl.s.*). There are no post-temporal plates.

The air-bladder has the usual cordate shape, but its walls are exceptionally stout and rigid (fig. 48). Its anterior wall is traversed by a deep median vertical groove, due to the impression of the subvertebral process (*sv.p.*). As in most other normal Siluridæ, the cavity of the bladder is subdivided into an anterior (*a.c.*) and two lateral chambers (*l.c.*) by the usual  $\Lambda$ -shaped disposition of the primary transverse (*t.s.*) and longitudinal (*l.s.*) septa; and the cavity of each lateral compartment is further subdivided by several secondary transverse septa (*t.s.'*). Strong buttresses of fibres pass from both faces of the secondary septa, and also from the posterior face of the principal transverse septum, and extend into the adjacent portions of the ventral wall of the two lateral compartments. The primary transverse septum (*t.s.*) is very thick, and inclines obliquely downwards and forwards from its dorsal attachment to the skeleton to its junction with the ventral wall of the bladder. Here, as in *Platystoma*, the obliquity of the septum has the effect of causing the lateral compartments to extend forwards for some little distance beneath the anterior chamber. The dorsal margin of the septum is firmly attached to the posterior and lateral edges of the superficial ossifications where the latter invest the body of the fifth vertebra, and, externally to this, to the ventral surfaces of the transverse processes of the same vertebra. The mesial portion of the anterior face of the septum is thickened into two stout, forwardly projecting, parallel ridges, which are continued dorsally to the skeletal attachments of the septum; ventrally the ridges extend downwards, and, at the same time, curve forwards along the inner surface of the ventral wall of the anterior chamber, while still retaining their parallel relations (*r.s.*)\*; from the ventral wall the two ridges again extend dorsalwards on the posterior face of the anterior wall, where the fibres of which they are composed, with the addition of the remaining fibres of the median portion of the anterior wall, diverge in the form of two bundles (anterior pillars), and pass, one on each side of the complex centrum, to the lateral surfaces of which and to the radial nodules they eventually become attached. In the anterior wall the vertically disposed ridges are evidently the result of a special concentration of the vertical fibres, which normally, as in *Macrones*, form the inner stratum of the tunica externa in that region, while the

\* In fig. 48 only the lateral portions of the ventral wall of the anterior chamber have been removed, the median portion remaining intact, except that an oval window has been cut in it in order to show the parallel ridges on its inner surface. The same figure also shows the obliquity of the primary transverse septum, and the forward extension of the two lateral compartments.

parallel ridges of the ventral wall as clearly owe their existence to an excessive thickening of the inner stratum of longitudinal fibres, which continuously extends between the anterior wall and the primary transverse septum and their respective attachments to the skeleton. The special development of these fibres, and their concentration into strong inwardly projecting ridges, is probably to be correlated with the greater thickness of the walls of the anterior chamber in *Arius*. Functionally, the ridges may be compared to a more or less rigid skeletal structure, arch-like in shape, and with the convexity of the arch directed towards the ventral surface, thus rendering the anterior, posterior, and ventral walls of the anterior chamber rigid and unyielding, and therefore necessarily causing any increase or diminution in the internal capacity of the chamber to depend mainly, and probably solely, on the movements of its lateral walls. The projection of these ridges into the cavity of the chamber, combined with the strong median ridge which the impression of the subvertebral keel gives rise to in the dorsal wall, has the effect of reducing the communication between the lateral halves of the chamber to a relatively small oval foramen. (See *Ketengus typus*, fig. 50.) The walls of the compartment are perfectly smooth internally, and, laterally, are in contact with the cutaneous areas (fig. 48, *l.c.a.*).

In the arrangement and skeletal attachments of the fibrous sheets forming the walls of the anterior chamber, *Arius* exhibits several features in which it differs from *Macrones*, and many other normal Siluroids that we have so far described. In the proper anterior wall the fibres forming the median portions of both the inner and outer strata of the tunica externa are closely coherent, and on the ventral surface of the anterior end of the complex centrum split into two diverging bundles, which pass dorsally, one on each side of the median line, and at their dorsal margins have the usual insertions into the lateral surfaces of the centrum, the radial nodules, and the ventral ridges on the crescentic processes of the tripodes. (See *Batrachocephalus mino*, fig. 52, *a.p.*) Externally to these skeletal attachments, on either side, the two strata become more easily separable, although still connected by scattered fibres passing from one to the other, but the fibres of the outer stratum, instead of extending into the dorsal wall and becoming attached to the tripodes, are inserted by their dorsal edges into the whole extent of the decurved anterior margins of the transverse processes of the fourth vertebra, including the distal extremities of the two processes, the insertion being posterior to the dorsal attachment of the transverse membrane (fig. 52, *t.p.<sup>4a.</sup>, o.st.*). Traced from the anterior wall into either lateral wall the fibres of the outer stratum acquire the characteristic curvilinear disposition, and, if traced thence into the dorsal wall, converge in the form of thick triangular sheets to their ultimate insertion into the crescentic processes of the tripodes (*o.st.*). The fibres forming the inner stratum of the tunica externa of the anterior wall on either side of the median skeletally attached portion have the normal vertical disposition, but become longitudinal, or slightly oblique, if traced thence into the dorsal wall, where they cross at right angles the converging fibres of the outer

stratum to the outer side of each tripus, with which, however, they are in no way directly connected (fig. 48, *in.st.*). Traced from the anterior into the antero-lateral and lateral walls the fibres of the same stratum are still vertical, but in the dorsal wall become transverse, or at all events oblique, and nearly, if not quite, coincident in direction with the fibres of the outer stratum; nevertheless, none of these fibres appear to reach the tripodes, or become directly attached thereto, but thin away before reaching the crescentic processes of those ossicles. The inner stratum is relatively thin, and hence the triangular sheets which form the greater part of the dorsal wall of the anterior chamber are mainly composed of the converging fibres of the outer stratum. We have already pointed out that the subvertebral process is so closely applied to the anterior wall of the bladder as to produce in it a deep median groove, and we may add that the distal extremity of the process is attached thereto by fibrous tissue.

From a comparison of *Arius* and *Macrones* it will be obvious that the extent to which the anterior wall of the air-bladder is attached to the axial skeleton varies greatly in different Siluroids. In most of the genera with normal air-bladders that we have so far described, as for example in *Macrones*, the whole thickness of the mesial portion of the wall is attached dorsally to the lateral surfaces of the complex centrum, to the radial nodules, and to the ventral ridges of the tripodes, but laterally to this point, on each side, the inner and outer strata of the tunica externa behave differently in different genera. In *Macrones* and its allies both strata are continued into the dorsal wall, and eventually become inserted into the anterior part of the convexity of the crescentic process of each tripus. In *Arius*, on the contrary, the outer stratum in this region becomes disassociated, as it were, both from the tripus and the inner stratum, and firmly inserted by its dorsal margin into the anterior edge of the transverse process of the fourth vertebra. Variations may also be noted in the extent to which the fibres of the interior chamber are inserted into the tripodes. Thus in *Macrones*, all the fibres of the inner stratum in the lateral portions of the anterior wall, as well as those of the same stratum in the lateral walls, are prolonged into the dorsal wall and eventually become inserted into the tripodes; but in *Arius* the corresponding fibres, although traceable into the dorsal wall, thin away and disappear as a definite stratum without reaching or becoming directly attached to these ossicles. Hence it is that in the latter genus, the only fibres directly inserted into the tripodes are those which form the outer stratum of the tunica externa of the lateral walls and are subsequently prolonged into the dorsal wall in the form of stout triangular sheets, whereas in the former genus the fibres of both strata in the anterior as well as in the lateral walls, with the exception of the skeletally attached mesial part of the anterior wall, converge in the dorsal wall to the tripodes and are directly attached thereto. With reference to these variations it may be pointed out that *Platystoma* and other normal Pimelodinæ more closely approach the Arioid than the *Macrones* type in the extent and nature of the skeletal

attachments of the anterior wall of the air-bladder, but while agreeing with *Arius* in the insertion of the dorsal edge of the outer stratum of the tunica externa into the anterior margins of the modified transverse processes of the fourth vertebra, *Platystoma* differs from that genus in having the fibres of the inner stratum of the lateral portions of the anterior wall connected dorsally with the tripodes, even though, as in *Arius*, the fibres of the same stratum in the lateral walls fail to reach the ossicles in question; and, consequently, in this respect *Platystoma* occupies an intermediate position between *Arius* and *Macrones*.

The more extensive attachment of the anterior wall of the bladder to immoveable portions of the axial skeleton is evidently a further provision to counteract any tendency on its part to participate in the distension or contraction of the anterior chamber, and consequently helps to restrict any diminution or increase in the capacity of that compartment to movements of the lateral walls which alone can influence the Weberian ossicles.

Unlike *Platystoma* a transverse membrane can be readily recognized in *Arius* as a thin but tough and inextensible layer of transversely or obliquely arranged fibres divided into two lateral halves by the subvertebral process. Each half is attached by its inner edge to the lateral surface of the process, and dorsally to the corresponding radial nodule and dorsal lamina, and in addition to the whole extent of the ventral margin of the decurved anterior edge of the transverse process of the fourth vertebra, from its root to its pointed distal extremity. At the antero-lateral angles of the air-bladder the fibres of this membrane pass from the extremities of the transverse processes and blend with the adjacent portions of the ventral wall.

The existence in *Arius* of a transverse membrane distinct from that layer of the tunica externa of the proper anterior wall of the bladder, which is also dorsally attached to the anterior margins of the modified transverse processes, removes one difficulty as to the exact nature of these structures in some Siluridæ. In the case of *Platystoma fasciatum*, which, in this respect, agrees with the species dissected by us (*P. tigrinum*), that part of the anterior wall which is attached to the transverse processes is regarded by SÖRENSEN (37) as representing the greatly thickened inner stratum of the peritoneal coat ("la plèvre"), and is therefore the equivalent of that special portion of the superficial coat of the bladder hitherto referred to by us as the transverse membrane.\* In *P. tigrinum*, and presumably in *P. fasciatum* also, there is no transverse membrane distinct from the apparent proper anterior wall, and therefore, so far as these species are concerned, it is possible that the skeletally-attached outer stratum of the latter may be the equivalent of SÖRENSEN'S "la plèvre" and our transverse membrane. But in *Arius* a skeletally-attached outer stratum of the anterior wall and a transverse membrane coexist, and consequently the one can scarcely be an equivalent to the other in cases where either is absent. Hence to us it seems more reasonable to assume that the skeletally-attached stratum of the

\* See *Macrones nemurus*, p. 90.

anterior wall has much the same value both in *Arius* and *Platystoma*, and in each case is wholly or partially a portion of the tunica externa; and further, that the transverse membrane as a separable and distinct structure is entirely wanting in *Platystoma*—a fact which may possibly be associated with the extensive insertion of the great compressor muscles into the walls of the bladder. We have elsewhere, in our description of *Macrones*, given reasons for believing that even the transverse membrane is merely a special portion of the superficial coat of the air-bladder, which, for physiological purposes, has acquired certain fixed skeletal attachments, and with a similar object it is readily conceivable that, in addition, even a stratum of fibres belonging to the tunica externa of the anterior wall may also acquire a similar connection with rigid portions of the axial skeleton, such, in fact, as we have shown to be the case in *Arius* and in *Platystoma*, and other normal Pimelodinae.

On the whole the Weberian ossicles in *Arius pidada* are very similar to those of *Platystoma*. The anterior process of the tripus (fig. 49, *tr.a.*) is somewhat shorter and of greater width than in most other Siluroids. The crescentic process (*tr.c.*) is rather thicker than usual, apparently in accordance with the greater thickness of the stratum of fibres attached to it, but on the ventral surface of its root the thickening abruptly ceases, leaving at that point a slight ridge, which, like the ventral ridge in *Macrones*, receives the insertion of a slip of fibres derived from the median portion of the anterior wall of the bladder. The crescentic process has no heel-like projection as in *Macrones*, nor is its posterior margin deeply grooved as in *Platystoma*. Claustra are present in the form of elongated spicular ossicles, slightly curved at their inferior extremities, and situated one on each side of the foramen magnum in contact with the posterior margins of the exoccipitals.

The more important characteristics of the Arioid type as exemplified by *Arius pidada* may be summarized as follows:—

(*a.*) The exceptionally firm ankylosis of the skull with certain of the anterior vertebræ, through the fusion of the greatly developed accessory articular processes of the basioccipital and complex centrum to form a stout subvertebral process, and the sutural union of the transverse processes of the fourth vertebra with the supra-occipital by the extension of a pair of strong osseous laminae between the two structures.

(*b.*) The more extensive development of the superficial ossifications and their ventral and lateral extension to form complete bony canals for the dorsal aorta and the posterior cardinal veins.

(*c.*) The absence of post-temporal plates and the exclusion of the post-temporal bones from contact with the air-bladder, the modified transverse processes of the fourth vertebra, and the subvertebral process alone forming an effective bony support for its anterior wall.

(*d.*) The absence of compressor and tensor tripodis muscles, and of any tendency to



the development of antero-lateral or other cæcal appendages in connection with the air-bladder.

(e.) The more extensive attachment of the lateral portions of the tunica externa of the anterior wall of the bladder to the skeleton by the separation of their thick outer strata from the inner, and the dorsal insertion of the former into the transverse processes of the fourth vertebra.

(f.) The existence of a distinct transverse membrane in addition to the skeletally attached outer stratum of the proper anterior wall of the bladder.

(g.) The concentration of the inner stratum of longitudinal fibres in the median portion of the ventral wall of the anterior chamber into two stout, inwardly projecting parallel ridges, and their extension into the anterior and posterior walls to the skeletal attachments of the anterior and posterior pillars respectively.

(h.) The failure of the fibres of the inner stratum of the tunica externa in the antero-lateral and lateral walls of the anterior chamber to reach their usual insertions into the crescentic processes of the tripodes.

(i.) The suppression of the ascending and horizontal processes of the intercalarium and the reduction of that ossicle to a small nodule of bone imbedded in the inter-ossicular ligament.

It may be remarked that as regards the features indicated in paragraphs *b*, *c*, *e*, *h*, and *i*, *Arius* more or less closely resembles *Platystoma* and the other normal Pimelodinae; but the distinctness of the Arioid type is, nevertheless, sufficiently emphasized by the facts referred to under *a*, *d*, and *f*.

In addition to *Arius pidada*, we have dissected the following Indian and Malayan species of the genus:—

<i>A. sagor.</i>	<i>A. argyroleuron.</i>
<i>A. truncatus.</i>	<i>A. maculatus.</i>
<i>A. cælatus.</i>	<i>A. thalassinus.</i>
<i>A. venosus.</i>	<i>A. arioides.</i>
<i>A. utik.</i>	<i>A. australis.</i>

Of the African species, we have only been able to examine one example, viz., *Arius laticutatus*; and of the South American representatives of this widely-distributed genus, a solitary example of *A. assimilis*.

All these species very closely resemble one another and *Arius pidada* in the structure of the air-bladder and the nature of the correlated skeletal modifications. Whatever variations do exist, appear to relate mainly to the relative thickness of the walls of the bladder, the greater or less number of the secondary transverse septa in the lateral compartments, or the relative size of the lateral chambers as compared with the anterior chamber. As a general rule, and as in most other normal Siluroids, the size of the air-bladder is approximately proportional to that of the Fish; and in cases where it is otherwise, any diminution in its capacity takes place at the

expense of the lateral compartments; or, in other words, variations in the relative size of the anterior chamber in comparison with the bulk of the Fish are confined within narrower limits than is the case with corresponding variations in the size of the lateral chambers. The relation of such variations, and others of a similarly minor character, to particular species may be briefly noted.

In *Arius sagor* the subvertebral process is somewhat spatulate at its free distal extremity. The lateral walls of the anterior chamber are extremely thin over definitely circumscribed oval areas, which are in close relation externally with the lateral cutaneous areas.

In *Arius venosus* the walls of the bladder are not only very thick, but the component fibres of the tunica externa are so densely interlaced and matted together that their course can scarcely be traced beyond the triangular sheets of the dorsal wall of the anterior chamber.

In *Arius caelatus*, and in one or two other species, the outer wall of each lateral chamber is strengthened internally by numerous vertically-disposed rib-like aggregations of fibres, separated by narrow intervening slits, and these may even extend forwards into the outer wall of the anterior chamber.

In *Arius australis* the air-bladder has particularly stout and rigid walls, and the obliquity of the primary transverse septum, especially of its mesial portion, is so great that its ventral edge extends nearly as far forwards as the anterior wall of the bladder before coalescing with the ventral wall; hence, the lateral compartments are prolonged as gradually contracting cavities on the ventral side of the inclined septum, nearly as far forwards as the anterior wall of the anterior chamber, but nevertheless remain separated from each other by a corresponding extension of the longitudinal septum. To a greater or less extent, this feature is characteristic of most species of *Arius*, but it is exceptionally well marked in this particular species.

In *Arius latiscutatus* there is but one secondary transverse septum in each lateral compartment.

*Arius assimilis* differs in no essential respect from its East Indian and African allies. The walls of the air-bladder, however, are extremely thin. Two short rudimentary secondary transverse septa are present in each lateral compartment.

In CUVIER and VALENCIENNES' great work (8) the air-bladder in several species of *Arius* is said to be provided with thick extrinsic muscles, as, for example, in *Arius caelatus* and *A. milberti*. The latter species we have had no opportunity of dissecting, but certainly no such muscles are present in *A. caelatus*, or in any other species of the genus that we examined.

If Dr. TAYLOR'S account (38) of the air-bladder of *Arius gagora* be correct, this species must possess a bladder of a very different type from any that we have met with in other species of the genus. According to this observer, there are two air-bladders, one on each side, enclosed in an osseous cup attached by a narrow stalk to the body of the "first" vertebra, close to its junction with the cranium. The mouth

of each cup is said to be covered over by the common integument which, at this point, is extremely thin and adheres to the surface of the bladder, presenting, when the latter is distended with air, an "external elastic tumour" of an oval figure. The two air-bladders, which have no communication with each other, or with the alimentary canal, apparently derive their supply of air from a vascular tissue placed between the two cups where they are attached to the spine. The external coat is of a thin texture and argentine colour, and has a layer of fine adipose tissue interposed between it and the internal surface of the cup.

This description is so different from anything met with in other species of *Arius* that we are not at all surprised at DAY's statement (9, p. 708) that the air-bladder TAYLOR examined "could not have been in *Arius gagora*." From an examination of an example of this species taken at Mandalay, in Upper Burmah, DAY (*loc. cit.*) gives the following description of its air-bladder:—"Air-vessel large and somewhat heart-shaped, with a moderately thick external fibrous coat. On removing its front wall a longitudinal partition becomes apparent, but is not extended to its anterior portion. It has three transverse subdivisions forming it into five cavities, owing to the longitudinal partition commencing at the first transverse subdivision. These lateral cavities freely communicate with one another on the same side and with the opposite ones by means of the anterior chamber which does not possess any subdivision." From this account it is obvious that TAYLOR's description cannot apply to the air-bladder of a genuine *Arius gagora*, and, further, that this species possesses a perfectly normal bladder, subdivided internally by a primary transverse and a longitudinal septum, and, in addition, by two or more secondary transverse septa. It is not improbable that the species examined by TAYLOR was really *Callomystax gagata*; at any rate his description agrees fairly well with what we found in an example of the latter species.\*

According to JOHANNES MÜLLER (28) the air-bladder of *Bagrus (Sciades) emphysetus* (MÜLL. and TROSCH.) (= *Arius emphysetus*, GÜNTHER) is very long, and consists of three bladders disposed in a longitudinal series, and communicating through their connecting constrictions.

#### *Hemipimelodus borneensis.*

In almost every respect the skeleton and air-bladder of this species closely conform to the Arioid type as illustrated by *Arius pidada*.

The walls of the air-bladder are very thick, but somewhat thinner in the antero-lateral and lateral regions of the anterior compartment than elsewhere. The primary transverse septum is also very stout, and its width such as to render the orifices whereby the lateral and anterior chambers intercommunicate comparatively small. Three stout secondary transverse septa are present in each of the two lateral chambers.

\* See p. 171.

DAY (9) briefly refers to the air-bladder in what he then regarded as examples of two Indian species of this genus, viz., *H. cenia*, HAM. BUCH., and *H. viridescens*, HAM. BUCH., in the following terms:—"The air-vessel is placed transversely across the body of the anterior vertebra. It has an expanded globular portion on either side enclosed in a bony capsule, and with a transverse connecting tube." This account is so greatly at variance with what we found in *H. borneensis* that we were not surprised to learn that DAY ('Proc. Zool. Soc.,' 1876, p. 794) subsequently admitted that the specimens he examined were species of *Gagata* (= *Callomystax*).

*Ketengus typus.*

In this species also both the air-bladder and skeletal modifications are very similar to those of *Arius pidada*.

Owing to the prominence of the sub-vertebral keel, and the extent to which the parallel ridges from the anterior, ventral, and posterior walls project inwards, the communication between the lateral halves of the anterior chamber is reduced to a relatively small and somewhat triangular foramen. Three pairs of secondary transverse septa sub-divide the cavities of the two lateral compartments.

A lateral view of the air-bladder with the outer wall of the right side removed, showing the dorsal ridge formed by the impression of the subvertebral keel (*sv.k.*), the parallel ridges (*r.s.*), and the foramen by which the lateral halves of the anterior chamber communicate with each other, is represented in fig. 50. In the same figure the primary and secondary transverse septa are also seen extending between the dorsal and ventral walls of the bladder (*t.s.*, *t.s.*'). The lettering, *a.p.* and *p.p.* indicates the anterior and posterior pillars of the anterior chamber.

*Ælurichthys longispinis.*

This Mexican Siluroid also bears a strong resemblance to *Arius pidada*. The walls of the air-bladder, however, are much thicker, and the dorso-lateral regions of the lateral compartments are strengthened internally by numerous column-like aggregations of vertically arranged fibres, separated by narrow slits, which become less marked and finally disappear towards the anterior chamber.

*Ælurichthys Gronovii.*

Under the name of *Galeichthys Gronovii*, CUVIER and VALENCIENNES (8) briefly refer to the air-bladder of this species. The organ is said to be heart-shaped, broader in front than behind, emarginate anteriorly, and somewhat flattened.

These writers also describe the bladder as possessing certain extrinsic muscles. Two long, straight muscles are said to be connected with its *dorsal* surface, while its

ventral surface may be compressed by the contraction of two oblique muscles. If CUVIER and VALENCIENNES are correct in their description, the two oblique muscles may possibly correspond to the large compressor muscles which we have already described in the genera *Platystoma*, *Pimelodus*, and *Piramutana*. We have had no opportunity of examining this particular species, but we may safely assert that no such muscles, either dorsal or ventral, are present in *Æ. longispinis*.

*Batrachocephalus mino.*

In no essential feature is there any difference between the air-bladder and skeleton of this species and those of *Arius pidada*.

Relatively to the size of the body the air-bladder is rather large, and this is noticeably the case with the anterior chamber, which is both long and deep. Its walls are comparatively thin, and anteriorly are in close and extensive contact with large lateral cutaneous areas. Three pairs of secondary transverse septa incompletely subdivide the cavities of the two lateral compartments.

The general structure of the organ is represented in fig. 52, including the disposition and skeletal attachments of the principal sheets of fibres in the walls of the anterior chamber. In the left half of the compartment the arrangement of the fibres of the inner stratum of the tunica externa (*in.st.*) may be seen; on the right side the inner stratum has been removed so as to show the characteristic attachment of the outer stratum of the anterior wall (*o.st.*) to the transverse process of the fourth vertebra (*t.p.<sup>4a.</sup>*), and the curvilinear disposition of the fibres of the same stratum in the lateral wall, and also their convergence in the dorsal wall in the form of a triangular sheet (*o.st.'*) to their insertion into the crescentic process of the tripus.

*Osteogeniosus Valenciennesii.*

In most of its osteological details this species\* is almost identical with *Arius pidada*.

The air-bladder (fig. 51) is conical in outline, with a broad anterior, and a somewhat oval posterior, extremity. The anterior wall is rendered deeply emarginate in the median line by the impression of the subvertebral process (*sv.p.*) to which it is somewhat firmly attached by fibrous tissue. Internally the bladder is subdivided into anterior (*a.c.*) and lateral compartments (*l.c.*) by the usual transverse (*t.s.*) and longitudinal (*l.s.*) septa. The transverse septum has the normal attachment to the skeleton along its contracted dorsal edge, but towards the ventral margin widens considerably, and laterally is directly continuous with the ventral wall of the bladder;

\* The only reference to the air-bladder of this Indian Siluroid that we are acquainted with, is by DAY (9). He says, "In a specimen from Moulmein, taken in the river, the air-vessel was large, heart-shaped, having an internal longitudinal septum, and not enclosed in bone."

mesially, however, the septum becomes inclined obliquely forwards, and at the same time gradually narrows so as to form a thick triangular band of fibres, which extends as far forwards as the middle of the ventral wall of the anterior chamber, and finally becomes continuous therewith at its apex, as well as along its converging lateral margins. The two lateral compartments are continued forwards to the inclined median portion of the septum as far as the middle of the floor of the anterior chamber, in the form of two gradually contracting cavities, but remain separated from each other by a corresponding extension of the longitudinal septum along the posterior face of the inclined septum. Hence, as in some species of *Arius*, the anterior chamber is partially overlapped on its ventral side by the anterior extremities of both lateral compartments. A single, but extremely stout, secondary transverse septum (*t.s.*) incompletely subdivides the cavity of each lateral chamber.

The lateral and posterior margins of the bladder are curiously compressed, and form, as it were, a solid flattened rim with a crenulated outline, partially encircling the organ. With the exception of the anterior wall, the walls of the bladder are, perhaps, thicker than in any other normal Siluroid, and so densely are their component fibres interlaced and matted together, that it is only in the dorsal wall, and, to a slight extent in the lateral walls of the anterior chamber, from whence the fibres which are ultimately inserted into the tripodes are derived, that any definite arrangement of them can be made out. The outer walls of both the anterior and lateral compartments are also greatly thickened internally by the aggregation of the fibres composing the inner stratum of the tunica externa into stout, vertically-arranged bundles, separated from one another by intervening slit-like sacculi. By the formation of these bundles internally, and the compression of the peripheral margins of the bladder, the lateral walls attain a thickness of nearly 4.5 mm. The secondary transverse septa, and the posterior face of the primary transverse septum, are thickened at their dorsal and ventral margins into ramifying root-like bundles of fibres, which fray out into the dorsal and ventral walls of the bladder, and finally blend therewith.

Relatively to the size of the fish, the apparent size of the air-bladder, when seen externally, is not less than in the various species of *Arius*, but the actual capacity of the internal cavities, and especially of the lateral compartments, is really very much smaller. This is partly due to the extraordinary thickness of its walls, and to the stoutness of the different internal septa, but also in a great measure to the flattened condition of the entire organ.

The comparatively small anterior chamber has its antero-lateral angles prolonged outwards into two small caecal diverticula, which curve inwards in front of, and in contact with, the adjacent portion of the anterior wall. Each caecum (*al.c.*) is deeply sacculated along its anterior margin; but otherwise its cavity is simple and undivided, and freely communicates with that of the anterior chamber.

The skeletal relations and attachments of the walls of the anterior chamber, as

well as the structure of the triangular sheets of the dorsal wall and their mode of connection with the crescentic processes of the tripodes, are substantially the same as in *Arius pidada* and its allies, and this resemblance extends also to the condition of the Weberian ossicles.

Lateral cutaneous areas (*l.c.a.*) are formed by the divergence of the dorso-lateral and ventro-lateral muscles of the trunk, but a considerable amount of fatty tissue separates them from actual contact with the adjacent lateral walls of the anterior chamber of the air-bladder.

*Osteogeniosus macrocephalus* and *O. militaris*.

These species require no special notice. In each case the air-bladder is almost identical in structure with that of the preceding species.

GROUP :—BAGARINA.

*Bagarius Yarrellii*.

In *Bagarius* we again meet with an example of the effects of degeneration in retrogressively modifying the structure of the air-bladder.

CUVIER and VALENCIENNES (8) denied the presence of an air-bladder in *Bagarius*, but as far back as 1831, TAYLOR (38) had previously affirmed its existence in the form of two small sacs having no communication with each other or with the alimentary canal, and so small that each sac in a Fish weighing ten pounds was not larger than an ordinary garden pea. By the same observer it was also stated that the two sacs were situated one on each side of the body in a deep groove or furrow formed by the consolidated transverse processes of the cervical vertebræ, at about an equal distance from the common integument and the vertebral column, and immediately behind the pectoral fin. TAYLOR'S account was subsequently confirmed by DAY (9) in the following terms:—"Air-vessel small, consisting of two rounded portions situated on either side of the bodies of the anterior vertebræ, and partially enclosed in bone."

In the structure of the air-bladder and the nature of the correlated skeletal modifications *Bagarius* bears a strong resemblance to *Akysis* and *Acrochordonichthys*, but more particularly perhaps to *Glyptosternum*, of which an account will subsequently be given.

Mainly owing to the massive growth of the superficial ossifications the centra of the complex and fifth vertebræ are firmly ankylosed to each other, and to the skull (fig. 53). The centrum of the first vertebra is not only very small, but so completely is it enclosed within the contiguous concavities of the basioccipital and complex centrum, that no external indications of its existence can be detected. The centrum

of the complex vertebra (fig. 53, *c.c.*) is very long, and its deep and almost equal anterior and posterior concavities nearly meet in the centre of the bone. The fifth vertebral centrum (*v.*<sup>5</sup>) is much smaller, and although somewhat larger than the normal centra that follow it, otherwise resembles it. The sixth vertebra (*v.*<sup>6</sup>) is quite free.

The neural spines of the third and fourth vertebræ are confluent and together form a thin, high, compressed plate of bone which is not cleft or in any other way modified for the support of the interspinous bones of the dorsal fin. The spinous process of the fifth vertebra is quite distinct from the foregoing, and deeply cleft. The neural arches of the complex and fifth vertebræ are completely ankylosed together, but remain distinct from the arch of the sixth. Three nutrient foramina are visible on the ventral surface of the complex centrum, two of which form a pair, and belong to the third vertebra, while the other is posterior to the former and median in position, and may therefore be regarded as belonging to the fourth vertebra.

The transverse processes of the fourth vertebra are curiously modified, each being greatly expanded and having, except at its thick flat root, the anterior margin curved downwards and slightly backwards towards the posterior margin, which also curves slightly downwards to meet it (*t.p.*<sup>4</sup>). In this way the transverse processes form on each side a spout-like protuberance from the side of the complex vertebra, enclosing a cavity or recess which has complete bony walls in front, behind, and above, but is widely open towards the ventral surface. The anterior wall of each recess abruptly ceases at the flat root of the transverse process, and between its free inner margin and the lateral surface of the complex centrum there is a deep cleft, through which the tripus passes from its connection with the scaphium anteriorly to the air-bladder posteriorly. At the distal extremity of the process the anterior margin curves backwards towards the posterior margin to a somewhat greater extent than elsewhere, and slightly narrows the distal opening of the enclosed recess. The recess itself is somewhat oval in shape, being more expanded in the centre than it is distally or proximally. The anterior and posterior walls are fairly thick, but the dorsal wall thins away over a sharply-defined concave oval area, and consequently becomes adapted to the convex dorsal wall of the contained air-sac. The anterior lip of the distal aperture of the recess is marked by a roughened concave surface, which becomes applied to the stem of the post-temporal in such a way as to form, in conjunction with the latter, an articular socket for the proximal extremity of the clavicle. The transverse process of the fifth vertebra (*t.p.*<sup>5</sup>) is very strongly developed, with a pointed free distal extremity and an expanded root, the anterior margin of which is partially confluent with the decurved posterior margin of its spout-like predecessor; the process also helps to deepen posteriorly the recess in which each lateral air-sac is lodged. The two foramina visible on the ventral surface of the process transmit the rami ventrales of the fifth and sixth spinal nerves (*sp.n.*<sup>5</sup>, *sp.n.*<sup>6</sup>).

Without forming an aortic canal, or even more than the merest trace of a groove



for the dorsal aorta, the superficial ossifications invest and considerably thicken the lateral surfaces of the complex and fifth vertebral centra, and, probably as the result of a further extension of ossification into the dorsal portion of the aponeurotic membrane, extend even on to the lateral and ventral surfaces of the basioccipital, completely obscuring all external indication of the body of the first vertebra, and at the same time leading to the complete anchylosis of the base of the skull with the anterior vertebral centra. Faint traces of the intervertebral sutures between the centra of the complex and fifth vertebræ, and between the former and the basioccipital, may, however, be seen on the ventral surface (fig. 53). On each of the lateral surfaces of the complex centrum the superficial ossification is thickened into two longitudinal and parallel ridges, one lying dorsad to the other with a groove between them. The ventral ridge coincides with the ventro-lateral margin of the centrum, and is shorter than the dorsal ridge. Opposite the root of the spout-like transverse process the ventral ridge is produced outwards into a slender, triangularly-shaped, ventral process, the pointed apex of which is inserted into a thin, but tough, fibrous membrane investing the ventral wall of the lateral air-sac of its side (*v.p.*). The dorsal ridge (*d.r.*) appears to commence as a prolongation of the anterior margin of the transverse process of the fifth vertebra, and from thence is continued somewhat obliquely inwards and forwards along the side of the complex centrum, immediately beneath the root of the modified transverse process and dorsad to the ventral ridge, as far as the basioccipital, where it finally dies away beneath the lower lip of the external atrial aperture. The groove between the two ridges, which is much better marked on the right than on the left side, probably transmits the posterior cardinal vein and the paired anterior lobes of the mesonephros. A third ridge is formed by a thin prolongation of the anterior margin of the root of the modified transverse process, along the lower border of the forwardly-inclined neural arch of the third vertebra, as far as the upper lip of the external atrial aperture. Where this ridge and the dorsal ridge overlap, the former is dorsad to the latter, and in a narrow slit-like groove between the two the anterior process of the tripus (*tr.a.*) passes forwards to its attachment to the scaphium anteriorly. The external atrial aperture is situated at the anterior extremity of this groove, and near its hinder end the groove deepens into a pit, at the bottom of which the articular process of the tripus articulates with the lateral surface of the anterior third of the complex centrum; posteriorly, the groove opens into the recess enclosed by the spout-like transverse process.

We were unable to identify with certainty the usual oblique ridges on the sides of the complex centrum, or dorsal laminæ, neither could we detect any radial nodules. It may not improbably be the case, however, that the well-marked ridge (dorsal ridge) which leaves the ventral surface of each of the transverse processes of the fifth vertebra, and extends obliquely forwards and inwards along the adjacent lateral surface of the complex centrum, may represent both the lateral ridge and dorsal lamina of other and more normal Siluridæ; but if this be so, it is somewhat

surprising that these structures should be so well developed when the diminutive and rudimentary condition of the air-bladder is taken into consideration. It must be admitted, however, that our suggestion receives some support from the fact that in the allied genus *Glyptosternum*, where a definitely recognisable dorsal lamina is present, there is no trace of the dorsal ridge.

The post-temporal\* has its ascending process and stem somewhat expanded, but the inferior limb (*pt.i.*) is an extremely slender process, which, after leaving the stem, is firmly applied if not actually ankylosed to the distal extremity of the transverse process of the fourth vertebra, but nevertheless becomes detached therefrom as it passes inwards, and eventually fuses with the anterior end of the dorsal ridge on the lateral surface of the basioccipital. The socket for the clavicle is in part formed by a deep groove in the post-temporal at the junction of the stem with the inferior limb, and in part by the distal extremity of the modified transverse process which converts the groove into a tubular socket.

The air-bladder is represented by two thin-walled oval sacs, which occupy the bony recesses formed by the spout-like transverse processes of the fourth vertebra (fig. 53, *a.s.*). In proportion to the bulk of the Fish the size of the air-bladder is extremely insignificant, and it is evident that beyond a certain period, which is probably reached at a very early stage, the bladder does not increase in size with the growth of its possessor. In our specimen a very immature Fish, of not more than 6 inches in length, and probably weighing less than 3 ounces even when fresh, each air-sac was about 4 mm. long and 3.5 mm. wide, that is to say, about the size of an ordinary garden pea, which, according to TAYLOR (38), was also the size of an air-sac in a specimen weighing 10 pounds. We could discover no trace of any communication between the two sacs, or of lateral compartments, or of the existence of a ductus pneumaticus. The ventral surface of each sac is invested by a thin but tough fibrous membrane, which stretches between and is firmly attached to the decurved anterior and posterior margins of the modified transverse process, and would seem also to extend from one sac to the other across the ventral surface of the complex centrum. The distal openings of the bony recesses are closed by their respective lateral cutaneous areas, but the outer wall of each air-sac is separated from the latter by a certain quantity of fatty tissue, as well as by a portion of the lateral lobe of the liver. As in other Siluridæ, the walls of the air-bladder are firmly attached to the contiguous skeletal elements at certain points. The posterior wall of each air-sac blends with the investing fibrous membrane, which we must identify as the ventral portion of the superficial coat of the air-bladder, and the two are dorsally attached to the anterior margin of the transverse process of the fifth vertebra, and also to the posterior portion of the dorsal ridge as the latter passes on to the side of the complex centrum, much in the same way that the lateral portions of the posterior wall (*i.e.*, the primary transverse septum) of a normal anterior chamber are inserted into the dorsal lamina

\* In fig. 53 only the inferior limb is represented, the remainder of the bone having been removed.

—a fact which supports our suggestion that this ridge is in part the equivalent of the dorsal lamina in other Siluridæ. In a precisely similar manner the anterior wall is firmly adherent to the decurved anterior margin of the transverse process of the fourth vertebra. The inner wall of the air-sac is also attached to the dorsal ridge, where the latter traverses the side of the complex centrum. The only other point at which each air-sac is attached to a rigid portion of the skeleton is about the centre of its ventral wall, where the latter blends with its investing superficial coat, and both become firmly attached to the triangular outgrowth from the ventral ridge.

The straight posterior process of the tripus lies near the inner extremity of each air-sac in relation with the imperfect dorsal wall of the latter, but we were only able to detect a few fine-scattered fibres extending from the outer margin of the process obliquely outwards and forwards towards the antero-lateral and anterior walls of the sac. These fibres appear to be all that represent the thick triangular sheet of fibres which is so characteristic of each half of the dorsal wall of a normally developed anterior chamber, and are practically confined to rather less than the anterior half of the dorsal wall of the sac. In the posterior half of the dorsal wall we could detect only a thin stratum of connective tissue, which probably belongs to the tunica interna, although we could not with certainty detect any epithelium on its inner surface. No radial fibres could be made out.

The tripus (fig. 54, *tr.*), is a simple triradiate ossicle, with a long anterior process (*tr. a.*), which is connected with the scaphium by a relatively short interossicular ligament, a tapering articular process (*tr. ar.*), and a posterior division (*tr. c.*) which remains in a straight line with the anterior process, and tapers to a point at its hinder extremity without describing the normal crescentic curvature. The scaphium has no ascending process, but its horizontal spatulate portion terminates posteriorly in a spherical condyle. The intercalarium is a very small nodule of bone imbedded in the interossicular ligament. Claustra seem to be entirely absent.

The cavum sinus imparis and the atrial cavities are extremely small, but otherwise normal. We had no difficulty in detecting a transverse ductus endolymphaticus, but a most careful examination failed to reveal any trace of a sinus endolymphaticus.

#### *Glyptosternum platypogon.*

Under the name of *Pimelodus platypogon*, CUVIER and VALENCIENNES (8) describe this Siluroid as being devoid of an air-bladder. In a paper published in the Linnean Society's 'Journal,' vol. 13, DAY, in referring to *Glyptosternum telchitta* remarks, "I cannot detect any air-vessel in this species." In 1871 ('Proc. Zool. Soc. Lon.,' p. 289), DAY corrected his previous statement, and in again referring to the same species tersely describes the air-bladder as consisting of "two rounded lateral portions, very thin, and entirely enclosed by bone." In a later paper in the same year ('Proc. Zool. Soc.,' 1871, p. 714), he again refers in equally brief terms to *Glyptosternum* as having "an air-vessel in two rounded lateral portions, and enclosed in bony capsules,"

but in neither instance does he give any precise or detailed account of the organ. Of the general accuracy of DAY'S brief description there can be no doubt, inasmuch as *Glyptosternum* affords a further illustration of the type of rudimentary air-bladder to which we have already directed attention in our account of *Akysis*, *Acrochordonichthys*, and *Bagarius*, but as regards the extent to which the diminutive air-bladder is incapsuled by bone, his account does not accurately apply to *G. platypogon*, which is the particular species we have examined, and the one in which CUVIER and VALENCIENNES denied its existence.

Of the various abnormal genera that so far have come under our notice, *Glyptosternum* most nearly resembles *Bagarius* in the structure of the air-bladder, and the condition of the modified anterior vertebræ. The body of the first vertebra is, however, somewhat better developed, but, although clearly visible on the ventral surface, it is almost completely excluded from forming any portion of the floor of the neural canal by the apposition of the dorsal edge of the basioccipital and the corresponding margin of the complex centrum (fig. 55, *v.*). The first, the complex, and the fifth vertebræ (*v.*<sup>1</sup>, *c.c.*, and *v.*<sup>5</sup>) are rigidly united to one another and with the skull, but the union is entirely due to the character of the persistent sutural articulation of the different cranial or vertebral elements and not to their ankylosis, or to the growth of continuous superficial ossifications. The intervertebral sutures between the centra are clearly seen on the ventral and lateral surfaces, as also is the suture between the neural arches of the complex and fifth vertebræ on the lateral aspect. The body of the complex vertebra (*c.c.*) is much larger than that of the fifth vertebra (*v.*<sup>5</sup>), and in each case the anterior and posterior concavities are about equal in depth. The sixth vertebra (*v.*<sup>6</sup>) is quite free, being movably articulated with the foregoing.

The confluent spines of the third and fourth vertebræ together form a thin, triangular lamina of bone, with sloping anterior and posterior margins, and a pointed distal extremity (fig. 56, *n.s.*<sup>3</sup> and *n.s.*<sup>4</sup>). The anterior margin and distal end of the lamina are suturally united to a thin vertical plate of bone which grows downwards from the long, backwardly directed supraoccipital spine (*so.*). The spine of the fifth vertebra (*n.s.*<sup>5</sup>) is unusually stout, and, moreover, is cleft distally into two processes, which are flattened on their opposed faces, and bent slightly outwards for the support of the anterior interspinous bones of the dorsal fin.

Each of the transverse processes of the fourth vertebra is greatly expanded, and also tilted slightly upwards from its root outwards (figs. 55 and 56, *tp.*<sup>4</sup>). The root of the process is thick and flat, but for the distal two-thirds of its extent the process is comparatively thin, with its anterior and posterior margins curved downwards, whereby it becomes modified to form the roof and side walls of a transversely-disposed bony semicylinder, the cavity of which is open distally as well as proximally in the dry skeleton. The anterior margin not only curves downwards, but also a little backwards; the posterior margin is also decurved, but to a somewhat less extent than the former, and, with its distal extremity, which is prolonged outwards into a slender

pointed process, is firmly united by suture to the anterior margin of the transverse process of the fifth vertebra. Proximally, as well as distally, the anterior and posterior walls of the bony semicylinder contract somewhat, and hence the enclosed recess becomes oval in shape in accordance with the contour of the contained air-sac. As in *Bagarius* the roof of the recess becomes so thin over a well-defined oval area as to be almost transparent. Two small foramina perforate the thick flat root of the process, and serve for the transmission of the rami ventrales of the fourth and fifth spinal nerves (fig. 55, *sp.n.*<sup>4</sup>, *sp.n.*<sup>5</sup>). The transverse process of the fifth vertebra (figs. 55 and 56, *tp.*<sup>5</sup>) is unusually long and stout, with a free distal extremity, which is slightly recurved, and an anterior margin suturally articulated with the posterior margin of the preceding process. The origin of the process from the centrum, instead of from the neural arch like its predecessor, causes it to occupy a slightly more ventral position; and, although not actually in contact with the air-bladder, it nevertheless helps to deepen the recess in which that organ is lodged. Its root is perforated for the passage of the ventral division of the sixth spinal nerve (fig. 55, *sp.n.*<sup>6</sup>).

The superficial ossifications are but feebly developed in *Glyptosternum*. The sides of the centra of the first, the complex, and the fifth vertebræ are apparently somewhat thickened by superficial ossified deposit, but not continuously so, inasmuch as the intervertebral sutures are very evident, both on the lateral and ventral surfaces, and there is absolutely no trace of an aortic groove (fig. 55). On each of the ventro-lateral margins of the complex centrum there is a well-marked ventral ridge, and from this ridge, as in *Bagarius*, a thin, slender ventral process extends horizontally outwards to a point a little beyond, and ventrad to, the commencement of the oval recess enclosed by the modified transverse process of the fourth vertebra, and there terminates in a flattened and slightly expanded extremity (fig. 55, *v.p.*). At the junction of the flat root of the transverse process, with its more cylindrical distal portion, a slender spicule of bone (*d.l.*) grows downwards, and at its ventral extremity becomes firmly applied, if not actually ankylosed, to the dorsal or inner surface of the distal end of the ventral process. When the two processes meet, the vertical process gives off a slender prolongation, which passes horizontally forwards and a little downwards to articulate with a projection furnished by the free inner extremity of the decurved anterior margin of the transverse process (see left side in fig. 55, also in fig. 57). We have no difficulty in identifying the horizontally-disposed ventral process of *Glyptosternum* with the similarly situated process of *Bagarius*, and it is equally evident that the vertical process which meets its distal extremity is the equivalent of the dorsal lamina of other Siluroids. That the dorsal lamina in *Glyptosternum* does not reach the complex centrum is certainly peculiar, but it may be noted that its vertical and horizontal processes retain their normal relations to the posterior cardinal vein and the mesonephros, in that the latter structures pass between the former and the lateral surface of the complex centrum. The failure of the dorsal lamina to reach

the complex centrum is exactly paralleled by a precisely similar arrangement in some other abnormal Siluroids (*e.g.*, *Clarias*).

The ascending process of the post-temporal (figs. 56 and 57, *pt.a.*) forms an expanded plate at each of the postero-lateral angles of the skull, articulating with the pterotic in front, and above with the epiotic and supraoccipital; the stem of the post-temporal slightly overlaps the anterior lip of the distal aperture of the bony semicylinder, and is further continued as a tubular prolongation containing the lateral line canal along the upper or dorsal lip. From the stem the inferior limb of the bone (figs. 55 and 57, *pt.i.*) extends inwards, at first, in contact with the anterior wall of the semicylinder, but, subsequently, separating therefrom, passes obliquely forwards to articulate with a lateral projection on the surface of the basioccipital. At the junction of the inferior limb with the stem, there is a deep groove which is almost completely closed behind by the distal extremity of the tubular transverse process, and converted into a socket for the clavicle (fig. 55). In a somewhat oblique lateral view of the hinder part of the skull and the modified anterior vertebræ (fig. 56), the relations of these structures to one another are clearly shown, including the formation of the posterior face of the skull by the supraoccipital, exoccipital, and epiotic bones; the convex dorsal surface of the tubular transverse process, and its close contiguity to the skull; as well as the extension of the stem of the post-temporal backwards to strengthen the anterior and dorsal margins of the distal aperture of the recess for the air-bladder. The slender head of the clavicle may also be seen projecting upwards through its tubular socket, near the distal extremity of the modified transverse process (*t.p.*<sup>4</sup>), and between the latter and the inferior limb and stem of the post-temporal. On reference to fig. 57, a strong ligament may be seen passing from the distal extremity of the posterior process of the clavicle (*lgt., cl.p.*) along the ventral margin of the lateral cutaneous area of its side to an insertion behind into the ventral surface of the transverse process of the fifth vertebra (*t.p.*<sup>5</sup>).

In the outer wall of each auditory capsule, there is a deep basin-shaped depression of circular outline, the sides of which are formed by the prootic (fig. 55, *pr.o.*) and pterotic (*pt.o.*) in front, the pterotic and post-temporal (*pt.a.*) externally, the epiotic (*ep.o.*) and exoccipital (*eo*<sup>2</sup>.) behind, and the prootic and opisthotic plate of the exoccipital (*eo*<sup>3</sup>.) internally, while the supraoccipital (*so.*) occupies the centre of the depression. Although a somewhat conspicuous feature in a lateral or ventral view of the external surface of the periotic capsule, this curious depression merely serves the purpose of affording an extensive surface of attachment for certain muscles connected with the branchial arches and pectoral girdle, but its internal effect is to render the utricular recess exceptionally shallow when viewed from the interior of the cranial cavity. Several of the otic bones, and more particularly the prootics, are so extremely thin as to be almost transparent, and the same remark applies also to the opisthotic

plate of the exoccipital, especially where they form the external walls of the foveæ sacculi.

The foveæ sacculi, the cavum sinus imparis, and the atrial cavities appear to differ in no essential respect from the corresponding structures in other Siluridæ. The foveæ are, perhaps, somewhat larger than usual, while, on the contrary, the cavum sinus imparis is relatively smaller. Owing, it may be, to the large size of the foveæ, the cranial portion of the basioccipital is unusually wide, and, as the cavum and its atrial diverticula are relatively smaller than usual, the atria and their external apertures with the scaphia lie together within the cranial cavity and on the dorsal surface of the hinder part of the basioccipital. The large size of the foveæ also causes them to approach each other in the median line beneath the cavum sinus imparis, so that only a very thin vertical lamina of bone separates the two cavities.

As in *Bagarius* the air-bladder is completely constricted into two laterally situated oval sacs (fig. 57, *a.s.*). Each sac occupies and completely fills the central and similarly shaped portion of the recess enclosed by the modified transverse process of the fourth vertebra, and even projects ventrally beyond it, but nevertheless remains separated from the complex centrum by the length of the flattened root of the process. Externally the sac does not extend quite to the distal aperture of its bony recess, which to a slight extent is closed by the stem of the post-temporal, but principally by the lateral cutaneous area (*l.c.a.*) of its side.\* The ventral surface of each air-sac is closely invested by the anterior portion of the mesonephros which, at the antero-internal angle of the sac, is prolonged inwards and then backwards, and, accompanied by the posterior cardinal vein, passes between the inner wall of the sac and the dorsal lamina externally, and the lateral surface of the complex centrum internally. The mesonephros in conjunction with a portion of the lateral lobe of the liver, also fills up the interval between the outer extremity of each air-sac and the inner surface of the corresponding lateral cutaneous area. The superficial coat of the air-bladder is but feebly developed, although it has skeletal attachments similar to those already described in the case of *Bagarius*, and may also be traced across the ventral surface of the complex centrum as it extends from the ventral surface of one air-sac to that of the other. The inner third of the under surface of each sac is overlapped by the distal portion of the ventral process (fig. 57).

The attachments of the walls of each air-sac to rigid portions of the skeleton are in the main similar to those of *Bagarius*. Thus, each sac is connected with the walls of its bony recess as follows:—(i.) along the dorsal edge of its posterior wall by an outer stratum of fibres which apparently becomes detached from the rest and is inserted into the posterior margin of the demi-cylindrical transverse process; (ii.) along the corresponding line of the anterior wall by the insertion of the dorsal edge of the latter into the decurved anterior margin of the same process; (iii.) the ventral

\* The length of each sac is 4 mm. and the width 3 mm., the length of the Fish itself being five inches.

wall is firmly attached to the distal portion of the ventral process; and (iv.) the inner wall is similarly adherent to the dorsal lamina and its horizontal prolongation.

In the condition of the dorsal walls of the two air-sacs *Glyptosternum* exhibits an even more degenerate condition than what we believe to be the case in *Bagarius*, with the possible exception of a thin stratum of connective tissue investing the inner surface of the dorsal wall of each bony recess, which may represent the degenerate dorsal wall of the enclosed air-sac, the latter does not appear to be indicated by any definite stratum of fibres. We could detect no fibres derivable from the outer or anterior wall of the sac and converging in the dorsal wall towards the crescentic process of the tripus, although this ossicle retains its normal relations to the rest of the sac, and is easily seen in the usual position when the ventral wall has been removed. The dorsal edge of the anterior wall is wholly attached to the anterior margin of the tubular transverse process, and no fibres could be traced therefrom into the dorsal wall; an outer stratum of fibres in the posterior wall is similarly attached to the posterior margin of the same process, but the inner stratum thins away and disappears as a traceable layer without extending into the dorsal wall, as also is the case with the whole thickness of the outer wall. The inner wall, on the contrary, remains intact, and a few fibres are traceable therefrom to an insertion into the feebly concave inner margin of the crescentic process of the tripus. The latter fibres undoubtedly represent the remains of the characteristic radial fibres of other Siluridæ, and share with the remainder of the inner wall a fixed insertion into the dorsal lamina. In some instances we were able to detect a few fibres at the inner and posterior portion of the sac, which at one extremity were inserted into the distal extremity of the crescentic process of the tripus, and in the opposite direction were traceable into the adjacent portion of the posterior wall. It is possible that in such cases these fibres represent the sole remains of the triangular sheets of a normal air-bladder. In our description of a young *Bagarius* we referred to the existence of a few scattered fibres radiating outwards from the crescentic process of the tripus, forming an imperfectly fibrous dorsal wall to the air-sac, and subsequently extending into the anterior and antero-lateral walls. These fibres were so feebly developed that it is almost impossible to regard them as having any functional significance, and in older and more mature specimens, it is by no means improbable that they entirely atrophy, leaving each air-sac in a condition precisely similar to those of *Glyptosternum*.

We could detect no trace of any communication between the two air-sacs, or of the existence of a ductus pneumaticus.

The tripus is a triradiate ossicle, its three divergent divisions representing the anterior, articular, and crescentic processes (figs. 55 and 58, *tr.*). The anterior and articular processes (fig. 58, *tr.a.*, *tr.ar.*) are similar in shape, and of approximately equal length, and both taper towards their distal extremities. The crescentic process (*tr.c.*) is slightly longer than either of the other two processes, and although somewhat similar in shape has a faint inward curvature, but without forming the charac-



teristic crescent. The concavity of the process is related to the dorsal lamina in such a way that it lies to the outside of the latter, and at the same time partially encircles it (fig. 55). The scaphium has no ascending process, the small rounded condyle for articulation with the dorso-lateral edge of the centrum of the first vertebra being at the contracted posterior extremity of the spatulate process. The intercalarium is a very small nodule of bone imbedded in the interossicular ligament. The claustrum is either absent altogether, as appeared to be the case in one or two of our specimens, or, as in others, was apparently represented by a slender spicule of bone growing downwards from the lower border of the inclined neural arch of the complex vertebra towards the body of the first, and imbedded in the fibrous wall of the neural canal immediately behind the exoccipital.

As in *Bagarius* we had no difficulty in discovering a ductus endolymphaticus, but of a sinus endolymphaticus in the relatively small cavum sinus imparis we were unable to find any indication whatever. Our specimens of *Glyptosternum* were sufficiently well preserved to render our failure in the latter respect only explicable on the assumption that in this genus the sinus endolymphaticus has undergone complete suppression.

It is therefore obvious, from a comparison of the two forms, that as regards the condition of the air-bladder, and the nature of the associated skeletal modifications, *Glyptosternum* and *Bagarius* are in close agreement on all essential points, while differing to some extent in minor details, and further, that both are widely different from any of the normal species hitherto described. The better preserved condition of our examples of these genera enabled us to make a more satisfactory examination of the structure of the air-bladder and internal ear than was possible in the case of the similarly modified genera *Akysis* and *Acrochordonichthys*, and it may be worth while to institute a brief comparison between the former and those Siluridæ which possess air-bladders of the normal size and structure.

The more salient features in the air-bladders of *Bagarius* and *Glyptosternum* are clearly the result of degeneration, and can easily be conceived as due to the retrogressive modification of an originally normal organ. The two lateral air-sacs obviously represent the completely separated lateral halves of an ordinary anterior chamber longitudinally constricted from each other, the lateral compartments, always the most variable portion of the air-bladder in point of size, and the ductus pneumaticus having undergone total atrophy. No trace of the original communication between the two sacs persists unless a remnant of such a connection is to be found in the thin solid stratum of fibres which is continued from one sac to the other across the ventral surface of the centrum of the complex vertebra. But notwithstanding such indications of degeneration, it may be noted that the reduced air-bladder still retains the usual and normal attachments to fixed portions of the axial skeleton. Anatomically, at all events, the rigid skeletal attachments of each air-sac are capable of strict comparison with the similar connections of the walls of each half of

a normal anterior chamber, more particularly as they occur in such Siluridæ as *Arius* and its allies. The attachment of the anterior and posterior walls of each sac to the corresponding margins of the modified transverse process of the fourth vertebra are respectively represented in *Arius pidada* for example, by the almost precisely similar skeletal attachments of the dorsal edges of the anterior wall of the anterior chamber, and of the primary transverse septum or posterior wall. The attachment of the mesial part of the dorsal wall of a normal anterior chamber to the ventral surface and sides of the complex centrum is apparently in part represented in both *Bagarius* and *Glyptosternum* by the sheet of fibres which extends from one air-sac to the other, and is at the same time firmly adherent to the ventral surface of the centrum in question, and which we cannot but regard as the consolidated mesial portion of an originally normal anterior chamber. If, as we have suggested, the dorsal ridge of *Bagarius* is the equivalent of the oblique lateral ridge of the complex centrum and the dorsal lamina of one side, the attachment of the inner wall of each air-sac to it might reasonably follow from the constriction of an originally normal anterior chamber into two laterally-placed sacs, and the consequent approximation of their anterior and posterior walls at the inner extremity of each sac. The same remark will apply also to *Glyptosternum*, although in this Siluroid the dorsal lamina is more easily recognised. The superficial coat of the air-bladder is obvious enough in both genera, but while it retains its normal attachments anteriorly to the decurved anterior margin of the transverse process of the fourth vertebra, the atrophy of the lateral compartments has enabled it to enter into a similar attachment posteriorly to the hinder margin of the same process. It is by no means improbable that the marked downward curvature of the anterior margin of this process is largely due to the actual ossification of that portion of the superficial coat which we have hitherto called the transverse membrane. The peculiar ventral process which, on each side, grows out from the ventro-lateral edge of the complex centrum may also, with some probability, be regarded as due to the extension of bony deposit from the superficial ossifications of the complex centrum into the superficial fibrous coat.

But while retaining in a fashion the usual rigid skeletal attachments the relations of the walls of the air-sacs to the movable tripodes afford further indications of the effects of degeneration. We entertain no doubt of the practical atrophy of the dorsal wall of each sac, and the almost complete disappearance of the usual strata of fibres by which, in the normal anterior chamber, the lateral and antero-lateral walls are functionally connected with the tripodes. With the suppression of these fibres the absence of the peculiar crescentic curvature in the posterior division of the tripus must be associated.

We shall subsequently have occasion to discuss these facts from a physiological point of view, and we shall now merely remark that in our opinion it is quite clear, from the partial enclosure of the two air-sacs within bony capsules, combined with the skeletal attachments of their anterior, posterior, and ventral walls, that no volumetric

changes in the internal capacity of the sacs can possibly occur, except in the direction of the long axis of each through movements of its outer wall; and even if distension or contraction should take place in the latter direction, it is impossible that any motion could be imparted to the tripodes, by reason of the atrophy of the dorsal walls and the non-existence of the usual fibrous tracts by which such an effect is normally brought about. The extremely diminutive size of the air-bladder, when compared with the bulk of the Fish, taken in conjunction with such facts in the structure of the organ as those indicated above, force us to adopt the conclusion that the air-bladder in *Glyptosternum* and *Bagarius* must be regarded as a vestigial and functionless structure—a conclusion which receives additional support from the existence of similar retrogressive modifications in the Weberian mechanism, and in those parts of the internal ear that are specially related to it.

In our necessarily imperfect account of *Akysis* and *Acrochordonichthys* there were several interesting points that we were unable to determine with certainty, of which the most important were, the condition of the dorsal walls of the air-sacs, and the presence or absence of a sinus endolymphaticus. We cannot but think, however, that our tentative conclusions with regard to those genera derive considerable support from the results of our investigations of *Glyptosternum* and *Bagarius*. From the strong resemblance between the four genera in all essential osteological details, as well as in the general structure and skeletal attachments of their air-sacs, and in the condition of the Weberian ossicles, we now entertain but little doubt that, so far as *Akysis* and *Acrochordonichthys* are concerned, the agreement extends also to the atrophied condition of the dorsal walls, the suppression of the sinus endolymphaticus, and, in fact, to the rudimentary and functionless condition of both the air-bladder and Weberian mechanism.

*Glyptosternum conirostris*, STEINDACHNER.

We could detect no essential differences between this species and the preceding.

*Eucliptosternum* (sp. ?).

In an undetermined species of this genus given to us by Dr. DAY, we found the air-bladder and Weberian mechanism very similar in almost every detail to the corresponding structures in *Glyptosternum*.

*Hara Buchanani*.

We have had no opportunity of dissecting this Siluroid, but according to DAY (9) the air-bladder is "rather large and situated in the abdominal cavity, not enclosed in bone." It may, therefore, be concluded that the organ conforms to the normal Siluroid type.

*Amblyceps* (sp. ?).

The only reference to the air-bladder of this genus that we have been able to discover is by DAY (9), who includes *Amblyceps* in his list of Indian Siluridæ in which the organ is "wholly or partially enclosed in bone."

## SUBFAMILY :—SILURIDÆ STENOBRANCHIÆ.

## GROUP :—DORADINA.

*Ageniosus militaris*.

There is a brief reference to the air-bladder of this species by JOHANNES MÜLLER (28, fig. 10). The organ is said to be enclosed within a small osseous capsule formed by the "first" vertebra, which is open laterally, but divided in the median line by a bony partition wall. Two free blind diverticula from the bladder emerge posteriorly through two small apertures in the capsule.

From the division of its capsule into two cavities by an osseous partition, which is probably the centrum of the complex vertebra, it is highly probable that the air-bladder of *Ageniosus* is also constricted longitudinally into two laterally placed air-sacs, as in such forms, for example, as *Bagarius*, *Callomystax*, &c. The description is, however, too meagre to admit of detailed comparison with other types, but it may, nevertheless, be inferred, first, that the air-bladder of *Ageniosus* represents an abnormal and degenerate type, and secondly, that it bears a singular resemblance to the air-bladder of certain Cyprinidæ (e.g., *Botia*) in which the partially atrophied posterior section of the organ is free in the abdominal cavity, while the anterior is more or less completely enclosed within a bony capsule.

*Auchenipterus nodosus*.

The only reference to the air-bladder of this species that we have been able to discover is by JOHANNES MÜLLER. In a section of his valuable memoir (28) entitled "Ueber einen Springfeder-apparat zur Erweiterung der Schwimmblase bei mehreren Gattungen der Welse," MÜLLER includes *Auchenipterus* among those Siluridæ that possess a peculiar "elastic spring" mechanism for the compression of the air-bladder, the importance of which he was the first to recognize, although VALENCIENNES had previously referred to its existence in his description of the skeleton of *Synodontis*. In figs. 5 and 6, Plate 3, of the memoir (*l.c.*) the "elastic spring" apparatus and its relation to the air-bladder are figured.

The centrum of the first vertebra (fig. 59, *v'*) is much smaller than the centra of any of the normal vertebræ, but is nevertheless freely exposed both in the floor of the neural canal and externally on the ventral surface. The complex and three succeeding vertebræ are rigidly anchylosed together by the partial coalescence of their neural

arches, but more especially by the superficial ossifications which continuously invest the lateral surfaces of their respective centra. The complex and fifth centra are about equal in length and width. The centra of the sixth and seventh vertebræ are much smaller, although larger than those of the free normal vertebræ which succeed them. The neural arch and short, thick spine of the third vertebra are both inclined forwards over the body of the first vertebra and partially anchylose with the exoccipitals and supraoccipital. The feeble spine of the fourth vertebra is directed obliquely backwards and supports the anterior interspinous bones of the dorsal fin, but is quite distinct from the preceding spinous processes. The remaining neural spines in the region of the dorsal fin, with the exception of the one belonging to the fifth vertebra are almost obsolete. The eighth vertebra is free and movable.

By a singular modification, each of the transverse processes of the fourth vertebra becomes converted into the "elastic-spring" apparatus of MÜLLER. The root of the process is a thin, highly elastic lamina of bone growing obliquely outwards from the neural arch and the backwardly inclined spine of its vertebra, and curving slightly downwards, with its anterior face looking obliquely upwards and forwards, and its posterior surface downwards as well as backwards (fig. 59, *t.p.*<sup>4</sup>). At its distal extremity the root expands into an antero-posteriorly flattened oval plate, composed for the most part of loose, cancellous and almost friable bone (fig. 59). As the result of the ventral flexure of the elastic root the two surfaces of the plate look inwards and outwards respectively, but the slight obliquity of the plate gives to the inner surface a tendency to look downwards and backwards, and to the outer surface an upward and forward inclination. The outer surface of each plate is somewhat convex, and the curious concentric and radial striations which traverse it are so related to a point on the dorsal margin, near its anterior extremity, as to render the surface very similar in appearance to the external face and umbone of an inequilateral Lamellibranch shell. The inner surface, on the contrary, is faintly concave and has only the radial striations. Between the free ventral margin of each plate and the commencement of the flexible root, there is a deep, but narrow, slit-like groove into which the thin outer edge of the crescentic process of the tripus is received (*tr.c.*). The inner surfaces of the two plates are closely applied to thin oval areas in the antero-lateral regions of the anterior compartment of the air-bladder. A specialized portion of the dorso-lateral musculature of the body wall becomes separated from the rest to form a strong protractor muscle for each of the oval plates. This muscle has its origin on the external surface of certain bones forming the posterior face of the skull, viz.: the posterior plate of the exoccipital and the epiotic, and from thence is continued downwards and backwards to its insertion into nearly the whole extent of the external surface of the oval plate (fig. 61, *pt.m.*). By the contraction of this muscle each plate may be pulled outwards and upwards, the elasticity of its flexible root allowing such movement to take place, but at once compelling the plate to return to its previous position when the muscle ceases to contract. The transverse

processes of the fifth vertebra (fig. 59, *t.p.*<sup>5</sup>) are very rudimentary, being reduced to the condition of short, slender, spicular outgrowths. Like their predecessors they arise from the arch of their vertebra by thin obliquely set roots, and are widely separated both from the former and from the transverse processes of the sixth vertebra. The latter, with the ribs which they carry (*t.p.*<sup>6</sup>, *r.*'), are more strongly developed than any that follow them, but are otherwise normal.

Thick superficial ossifications invest the lateral and ventral surfaces of the complex and two succeeding vertebral centra, but the sides only of the seventh centrum (fig. 59, *s.o.s.*). Beneath the centra of the complex, and the fifth and sixth vertebræ, the ossifications meet and blend in the median line to form the walls of a complete aortic canal (*a.c.*). Dorsally and laterally the ossifications do not extend on to the ventral surfaces of any of the transverse processes, but terminate in a sharp longitudinal ridge on each side which forms the inferior boundary of a groove for the posterior cardinal vein. Lateral ridge-like thickenings (*l.r.*) are developed on the sides of the anterior extremity of the complex centrum, and apparently mark the anterior limit of the superficial ossifications; these ridges coincide with the dorsal insertion of the median section of the transverse membrane, and also of a portion of the fibres forming the corresponding region of the anterior wall of the air-bladder. Radial nodules (*r.n.*) are represented by two elongated, slender nodules of bone lying along the lateral surfaces of the complex centrum at the dorsal extremities of the oblique lateral ridges, but united to the centrum by fibrous tissue only. There are no ossified dorsal laminæ.

The rigid connection of the anterior section of the vertebral column and the skull is secured by a peculiar development of dermal plates. The dorsal extremities of the two anterior interspinous bones are expanded into broad dermal plates, which are exposed on the dorsal surface behind the supraoccipital spine (fig. 61, *i.s.*<sup>1</sup>, *i.s.*<sup>2</sup>). The more anterior of the two (*i.s.*<sup>1</sup>) overlies the interval between the divergent spines of the third and fourth vertebræ, and articulates in front by a straight suture with the supraoccipital spine (*s.o.*'), and behind with the posterior plates (*i.s.*<sup>2</sup>) by a concavo-convex suture, the two plates, with the greatly expanded spine of the supraoccipital, forming a strong bony armature for the dorsal region of the trunk behind the head. At each of the postero-lateral angles of the skull, and overlying the true epiotic element, there is a third dermal plate (*ep.o.*) wedged in between the ascending process of the post-temporal (*pt.a.*) and the pterotic (*pt.o.*) in front, and the supraoccipital and the two dermal interspinous bones behind and above, but having its outer margin free. From its posterior margin the dermal portion of the epiotic is prolonged backwards and downwards as a slender process of bone, which coincides with the superior margin of the lateral cutaneous area of its side, and serves for the anterior insertion of part of the dorso-lateral muscles of the body wall.\*

\* As in *Glyptosternum*, the post-temporal, exoccipital, and epiotic bones form the walls of a deep basin-shaped depression near each of the postero-lateral angles of the cranium.

The post-temporal has the usual shape. The ascending process (fig. 61, *pt.a.*) suturally articulates with the dermal epiotic plate (*ep.o.*) and the pterotic (*pt.o.*) above, while the inferior limb (fig. 59, *pt.i.*), which is unusually stout, is firmly applied to a strong lateral outgrowth from the basioccipital (*bo.*). The inner surface of the stem, and the contiguous portion of the inferior limb, form between them a deep groove-like socket for the bifid head of the clavicle, but, as might be expected, no portion of the post-temporal has any articular relations with the flexible transverse process of the fourth vertebra. The posterior process of the clavicle (*cl.p.*) is strongly developed, and by its extension backwards marks the inferior boundary of the lateral cutaneous area of the same side.

The air-bladder is rather large in proportion to the size of the Fish, and broadly ovate in shape, with its anterior third somewhat contracted or pinched in by the application of the oval plates of the "elastic spring" apparatus to its lateral surfaces (fig. 60, *a.b.*). The walls of the bladder are very thin. Internally, the cavity of the organ is subdivided in the usual way into an anterior and two lateral compartments by primary transverse and longitudinal septa. The transverse septum (*t.s.*) is a fairly stout vertical pillar of fibres, continuous posteriorly with the longitudinal septum (*l.s.*). Dorsally, the transverse septum splits into two bundles of fibres, which pass on either side of the body of the sixth vertebra, and at the same time curve forwards as well as upwards to the ultimate insertions into the lateral surfaces of both the sixth and fifth centra. Through the narrowness of the septum, the apertures whereby the lateral and anterior compartments intercommunicate are unusually wide. The outer and posterior walls of the lateral chambers are strengthened internally by numerous vertically-disposed ridge-like aggregations of fibres, which are stoutest behind, but gradually become less marked as they are traced into the anterior chamber, where they finally disappear. There is no trace of secondary transverse septa. A ductus pneumaticus is present.

The attachments of the air-bladder, both to rigid and to movable portions of the skeleton, are substantially the same as in *Macrones*. The mesial section of the anterior wall of the bladder is attached dorsally to the ventral surface and oblique lateral ridges of the complex centrum, to the radial nodules, and also to the feebly developed ridges on the ventral surfaces of the crescentic processes of the tripodes. Externally to these attachments, and on each side, the fibres of the tunica externa have the same general arrangement in the lateral and antero-lateral walls as in *Macrones*, and converge in the dorsal wall in the form of triangular sheets to their ultimate connection with the tripodes (fig. 60). The thin median portion of the dorsal wall of the anterior chamber is restricted to that part which invests, and is firmly attached to, the lateral and ventral surfaces of the complex and fifth vertebral centra, inasmuch as, from the peculiar shape of the crescentic processes of the tripodes, and the absence of their usually widely open curvature, the oblique posterior margins of the triangular sheets are in close relation with those centra. Over a well defined

oval area in each of the antero-lateral regions of the bladder the tunica externa becomes extremely thin, though still retaining its normal structure of an inner layer of vertically arranged fibres, and an outer stratum of curvilinear fibres. The thinness of these areas is principally due to the extreme tenuity of the outer stratum. The dorsal edges of the fibres forming each oval area are inserted into the outer rim of the thickened inner margin of the crescentic process of the tripus, immediately behind the insertion of the mesial fibres of the anterior wall into the ventral ridge of the same ossicle. To these oval areas the bony plates of the "elastic-spring" mechanism are so closely, and even forcibly, applied, that in all our specimens of this species the antero-lateral walls of the anterior chamber were distinctly pinched in (fig. 60).<sup>\*</sup> Apart from a delicate connective tissue which extends between them, the oval areas are not specially attached to the bony plates; at all events, in spirit-preserved specimens the two structures readily separate from each other. The radial fibres of the tripus (*r.f.*) are somewhat feebly developed, and, from the peculiar shape of the crescentic process of that ossicle, pursue an almost straight course forwards as they pass from the latter to their connection anteriorly with the radial nodule.

A thin transversely-disposed membrane is closely applied to the proper anterior wall of the bladder, and is attached dorsally to the lateral ridges of the complex centrum; laterally to this the membrane becomes continuous with the margins of each oval plate of the "elastic spring" mechanism, and from thence becomes lost on the lateral and ventral surfaces of the bladder.

In shape, the tripus (fig. 59, 62 and 63, *tr.*) is very unlike that of most other Siluridæ, although it possesses the three characteristic divisions. The ossicle is almost straight, the posterior or crescentic process (*tr.c.*) being almost a direct continuation backwards of the anterior process (*tr.a.*), with not more than the faintest suspicion of the usual inward curvature. Both processes are much flattened, but the crescentic process is almost twice the length and width of the anterior division (fig. 62). The ventral surface of the root of the crescentic process is traversed by a faint oblique ridge (*v.r.*); the outer margin is extremely thin, and fits into a slit-like groove at the junction of the oval plate with the flexible root of the "elastic spring" apparatus (fig. 59, *tr.c.*); the inner margin, on the contrary, is curled inwards on itself, so as to form a thickened rim on the ventral surface, and, moreover, is somewhat longer than the outer margin (fig. 62). As previously mentioned, the ventral ridge of the tripus receives the insertion of a slip of fibres derived from the median portion of the anterior wall of the bladder; the thickened inner rim of the crescentic process receives on its inner edge the insertion of the radial fibres from the radial nodule; while the outer margin of the

<sup>\*</sup> SÖRENSEN'S conclusions (37) with regard to *Dorås* and *Synodontis*, viz., that the oval plates of the "elastic-spring" apparatus owe their formation to the ossification of "la plèvre" (= the transverse membrane) and the tunica externa of the bladder itself, may be extended also to *Auchenipterus*. The relations of the transverse membrane to the terminal plates in this genus, and the extreme tenuity of the walls of the bladder where the plates are applied to them, are quite in harmony with this suggestion.



rim has attached to it from before backwards, first, the dorsal edges of the fibres derived from the corresponding antero-lateral wall of the anterior chamber and traversing one of the thin oval areas, and, secondly, the fibres primarily derived from the remaining portion of the lateral wall, as well as those converging from the outer wall of the lateral compartment of the same side. The thin outer rim of the crescentic process does not receive the insertion of any of these fibres, as the latter simply cross its ventral surface on their way to the thickened inner rim, which is consequently the only portion of the tripus that can be seen imbedded in the dorsal wall of the bladder after the removal of the tunica interna (fig. 60, *tr.c.*). The unusual length of the crescentic process seems to be associated with the relatively large size of the anterior chamber, and also with the fact that the process not only receives the insertion of the fibres derived from the antero-lateral and lateral walls of the anterior chamber, but also from the outer wall of the contiguous lateral compartment. The absence of any marked curvature in the process may also have conditioned its somewhat exceptional length. At the junction of its anterior and crescentic processes a thin, flexible, and highly elastic, triangular lamina of bone is given off from the dorsal surface of the tripus and at right angles to it (fig. 63, *tr.ar.*). The surfaces of the lamina look almost directly backwards and forwards respectively, and the inner margin, from its junction with the body of the tripus to the pointed dorsal extremity of the lamina, is confluent with the neural arch of the complex vertebra along a line which is slightly oblique from below upwards and forwards. This lamina undoubtedly represents the articular process of other Siluroids, from which, however, it differs in being directly continuous with the neural arch instead of articulating with the lateral surface of the centrum at the bottom of a deep pit-like socket. Consequently the movements of the tripus in *Auchenipterus* will not depend on a normal articulation, but solely on the flexibility and elasticity of its peculiar articular process. Then again, in most Siluridæ with normal bladders, it is the radial fibres of the tripus which cause that ossicle to move inwards towards the complex centrum when the lateral distension of the anterior chamber has ceased to separate the two, but in *Auchenipterus* the function of the radial fibres, which, from their relatively feeble development and nearly straight antero-posterior course, is possibly less efficient than in other Siluroids, must be powerfully supplemented by the elasticity of the articular process. As in all probability the tripus is to be regarded as the modified transverse process of the third vertebra it will at once be obvious that it presents a striking resemblance to the corresponding process of the fourth vertebra. In each case there is a flexible and elastic root directly continuous with the neural arch of its vertebra and in distal continuity with a movable plate of bone—the body of the tripus in the one case and the oval plate of the “elastic-spring” apparatus in the other. The fact may also be recalled that as regards the thinness of its root and the curious obliquity of its origin from the neural arch the

transverse process of the fifth vertebra, although neither flexible nor elastic, strongly resembles the two preceding processes.

In reference to the movements of the tripus it seems to us not improbable that the relation of its crescentic process to the slit-like groove between the oval plate and the elastic root of the transverse process of the fourth vertebra must also, to some extent, limit and control the lateral motion of that ossicle, even if it does not altogether prevent the possibility of any such movement, when the protractor muscle is quiescent and the plates are not pulled outwards and upwards. On the other hand, the contraction of these muscles, and the consequent upward and forward movement of the plates, will necessarily confer upon the tripodes a wider range of possible lateral motion. In fact, as we shall subsequently have occasion to point out more in detail, any increase in the volume of the anterior chamber of the air-bladder will mainly depend on the movements of the oval plates in the way just described, but it is precisely such movements that will give to the tripodes an increased range of lateral motion, and, at the same time, the capacity for registering the degree of distension of the bladder. Conversely, the compression of the air-bladder by the elastic recoil of the plates when their protractor muscles cease to contract, will necessarily have the effect of confining the movements of the ossicles within comparatively narrow limits.

In the general structure of the various parts of the internal ear, and of the recesses in which they lie, *Auchenipterus* closely agrees with *Macrones*.

Lateral cutaneous areas are well marked, but the oval plates of the "elastic-spring" mechanism, to a large extent, prevent the lateral walls of the anterior chamber from coming into direct contact with them, but behind the plates the lateral walls, and to some extent the outer walls of the lateral compartments also, are in close relation with these areas. The spaces between the plates and the superficial skin are occupied partly by the large protractor muscles, and partly by a yellowish fatty tissue.

#### *Auchenipterus obscurus.*

But for one or two minor points of difference, this species very closely resembles the preceding one. The superficial ossifications are somewhat more extensively developed, inasmuch as they extend on to and invest the lateral surfaces of the eighth vertebral centrum, so that the ninth is the first of the flexibly articulated series. A further distinctive feature is to be found in the presence of a small cæcal diverticulum which is given off from the posterior and outer extremity of each of the lateral compartments of the air-bladder.

#### *Euanemus.*

Since JOHANNES MÜLLER (28) first recorded the existence of an "elastic-spring"

apparatus in this South American genus, the relations of the mechanism to the air-bladder have been carefully described by SÖRENSEN (37) in *E. nuchalis*.

Instead of each terminal disc or plate being flat on its posterior face, or only slightly concave, it is hollowed out in the form of a pouch. The formation of these singular structures and their relations to the tunica externa of the air-bladder are thus described by SÖRENSEN :—“ la membrane externe de la vessie natatoire est ossifiée en dehors (ou en avant), et en haut, au bord du disque, l'ossification s'étend dans toute son épaisseur, tandis que, près du bord supérieur du disque, cette membrane n'est ossifiée sur la face interne (ou postérieure) que dans une petite étendue.” (*Loc. cit.*, pp. 139–140.)

*Cetopsis candira*.

*Cetopsis* is one of the nine genera of Siluridæ in which JOHANNES MÜLLER (28) denied the existence of an air-bladder, and his statement on this point remained uncorrected until it was shown by one of us (4) that in *C. candira* the organ is undoubtedly present in a diminutive and bone-encapsuled condition. The description then given may now be supplemented in one or two minor features.

*Cetopsis* differs from all other Siluridæ with which we are acquainted in that the neural arch of the complex vertebra is not perforated by a single foramen for the passage of the roots of spinal nerves. The second to the fourth, inclusive, emerge between the exoccipital and the arch of the complex vertebra, the last-mentioned nerve traversing a slight notch in the anterior margin of the arch. The fifth nerve escapes between the arches of the complex and fifth vertebræ, while the sixth and remaining spinal nerves perforate in the normal fashion the arches of the fifth and succeeding vertebræ.

The transverse processes of the fourth vertebra are alone concerned in the formation of the osseous capsules for the enclosure of the rudimentary air-bladder, and are represented on each side by a hollow bony cylinder disposed at right angles to the long axis of the vertebral column. The formation of each cylinder is apparently due to the expansion of the transverse process combined with the downward curvature of its anterior and posterior margins, and their subsequent fusion on the ventral surface. The distal aperture of the cylinder is closed by the external skin and a deposit of subcutaneous fatty tissue, and to a slight extent also by the lateral musculature of the trunk. Proximally, the cylinder is continuous with the centrum and arch of the complex vertebra. Near its junction with the vertebra each cylinder is slightly bullate on its dorsal surface, but for the rest of its extent is of fairly uniform calibre. The bony walls of the cylinders are everywhere complete except at their distal extremities. Two foramina perforate the root of each cylinder, one on the ventral surface and the other in the anterior wall, both apertures being close to the junction of the cylinder with the complex vertebra; the first serves for the transmission of the ventral divisions of the second, third and fourth spinal nerves, while the second

admits of the passage of the tripus from the interior of the cylinder to its connection with the scaphium anteriorly. The transverse processes of the fifth vertebra have no share in the formation of the osseous capsules for the air-bladder, nor do they in any way differ from the normal rib-bearing processes that succeed them.

Except for the slenderness of its inferior limb the post-temporal is normal, and with the distal portion of the cylindrical transverse process forms the articular cavity for the clavicle.

The air-bladder is constricted into two small, extremely thin-walled, laterally placed, oval air-sacs, which occupy the slightly inflated proximal portions of the two bony cylinders. Each sac in a Fish 8 inches long was only 6 mm. in length, but, nevertheless, had structurally perfect walls. The walls of each sac are in close relation with those of its investing bony capsule, without, however, being specially attached thereto, except at one point where the inner wall is adherent to the lateral surface of the complex centrum. The solitary specimen examined by us had been eviscerated before dissection, but a most careful examination failed to reveal the existence of any communication between the two sacs, or of any trace of a ductus pneumaticus.

A scaphium without either condylar or ascending processes is present, but neither intercalaria or claustra could be detected. The tripus is very similar to that of *Bagarius*, except that it has only the barest rudiment of a straight "crescentic" process for insertion into the antero-internal portion of the dorsal wall of the corresponding air-sac. No obviously specialized radial fibres could be made out, but are probably represented by that part of the inner wall of the air-sac which is attached to the complex centrum. There are no radial nodules.

The cavum sinus imparis and the atrial cavities appeared to be perfectly normal, but relatively of small size. Unfortunately, the auditory organ was too badly preserved to admit of a satisfactory examination of its structure being made.

#### *Doras maculatus.*

The existence of an "elastic-spring" apparatus in this South American species was first described by JOHANNES MÜLLER (28), but a more detailed account of the relations of the mechanism to the walls of the air-bladder has recently been given by SÖRENSEN (37, Plate 2, figs. 15, 16). In an earlier paper by the same author (36, Plate 3, fig. 44, and Plate 4, fig. 43), the bladder itself is figured.

From SÖRENSEN'S figures it would appear that as regards its skeletal modifications, and the mode of formation and relations of its "elastic-spring" mechanism, *Doras* exhibits a fairly close resemblance to *Auchenipterus* and *Oxydoras* in all essential features. The thick discoidal terminal plates of the mechanism are closely applied to the antero-lateral regions of the bladder. There seems to be no recognisable posterior division to the transverse process of the fourth vertebra, and the fifth vertebra has

but a pair of rudimentary processes which are widely separated from those of the fourth and sixth (*loc. cit.*, Plate 2, figs. 14–16).

The air-bladder is partially constricted into two portions, of which the anterior is cordate in shape, and subdivided internally\* into the usual anterior and lateral compartments by transverse and longitudinal septa (*loc. cit.*, Plate 4, fig. 43). The posterior portion (*loc. cit.*, Plate 3, fig. 44), is a long internally sacculated cæcal appendage, closely resembling the corresponding structure in *Malapterurus*. Unlike all other Siluridæ in which an “elastic-spring” mechanism is present, the anterior chamber is fringed on each side by a series of variously-sized more or less branched, tubular cæca. Over the circular or somewhat oval areas, where the terminal discs of the two elastic springs are applied to the walls of the anterior chamber, only the thin, delicate, transparent tunica interna is present. On this point, and with reference to the mode of formation of the discs, SÖRENSEN (*loc. cit.*, p. 139) remarks:—“Chez le genre *Doras*, il\* se termine en un disque rond et épais qui est une ossification de (la plèvre et de) la membrane externe de la vessie natatoire dans toute son épaisseur, de sorte qu’en ouvrant la vessie natatoire on aperçoit ce disque à travers la membrane interne pellucide.” According to SÖRENSEN, therefore, the thickened discs in which the transverse processes of the fourth vertebra terminate distally are to be regarded as owing their formation to the extension of ossification from the transverse processes into the transverse membrane (la plèvre), and the whole thickness of the tunica externa.

The crescentic process of the tripus (*loc. cit.*, fig. 15) has apparently the same shape as in *Auchenipterus*.

#### *Oxydoras brevis.*

We are not acquainted with any previous reference to the air-bladder of *Oxydoras*, nor are we aware that the presence of an “elastic spring” apparatus in this genus has hitherto been recorded.

In all essential features the modified anterior vertebræ and their processes are similar to those of *Auchenipterus nodosus*. The transverse processes of the fourth vertebra are modified to form an “elastic spring” mechanism. The deflected distal portion of each process (fig. 64, *t.p.*<sup>4</sup>) forms, however, but a slightly expanded and inwardly curved plate with a thickened outer margin and an almost nodular extremity. Near the junction of each plate with its elastic and flexible root there is a slight groove into which the outer margin of the crescentic process of the tripus is received. As in *Auchenipterus*, the modified transverse process has no trace of a posterior division, but, unlike that genus, the fifth vertebra has scarcely any trace of transverse processes, and, as is usually the case where the lateral surfaces of the body are protected by an armature of dermal bony plates (*e.g.*, the Loracaroid Siluridæ), the first pair of ribs are exceptionally massive. The radial nodule (*r.n.*) is an elongated spicule of bone, somewhat loosely attached by fibrous tissue to the lateral surface of the complex centrum.

\* The transverse process of the fourth vertebra.

Its slightly thickened dorsal extremity is almost in contact with the inner margin of the root of the crescentic process of the tripus (*tr.c.*), with which it is connected by a few short radial fibres. The inferior limb of the post-temporal (*pt.i.*) is very massive, and articulates internally with the basioccipital (*bo.*), and along its dorsal edge with the angle which the posterior and opisthotic plates of the exoccipital make with each other at the postero-lateral region of the skull.

The air-bladder (fig. 66) is also very similar in shape and relative size to that of *Auchenipterus*. The anterior chamber (*a.c.*) is fairly large, and its lateral walls are in close and extensive contact with the superficial skin. The transverse septum (*t.s.*) is attached dorsally to the body of the fifth vertebra, and anteriorly to this to a longitudinal ridge which traverses each of the lateral surfaces of the complex centrum and marks the dorsal limit of the superficial ossifications, and also coincides with the inner margin of the corresponding triangular fibrous sheet of the dorsal wall of the anterior chamber. The lateral portions of the anterior wall of the bladder are extremely thin and translucent where the distal plates of the "elastic spring" mechanism are applied to them, in fact, the latter project into the cavity of the anterior chamber, pushing in the thin wall of the bladder before them. At the point of closest contact of the two structures the tunica externa is entirely wanting, and only the thin inner tunica invests the inwardly projecting extremities of the two plates.\* The peripheral margins of the plates are somewhat firmly attached to the wall of the bladder by connective tissue. The posterior extremity of the bladder has a small rudiment of a posterior cæcum (*p.c.*) sub-divided internally by a backward prolongation of the longitudinal septum which, anteriorly, separates the two lateral compartments from each other.

The Weberian ossicles are much the same as in *Auchenipterus*. The crescentic process of the tripus (fig. 65, *tr.c.*) is, however, shorter than the anterior process (*tr.a.*) and without a trace of any inward curvature. From the manner in which the fibres of the dorsal wall of the anterior chamber are connected with it the crescentic process appears somewhat triangular in shape when viewed from the ventral surface after the removal of the tunica interna (fig. 66). The articular process (*tr.ar.*) is a thin flexible lamina of bone, continuous with the arch of the complex vertebra, and in correlation with this modification the radial fibres are so feebly developed as to be almost non-existent.

#### *Synodontis schal.*

JOHANNES MÜLLER (28) has figured and described the "elastic-spring" apparatus of this African Siluroid and its relations to the air-bladder (*loc. cit.*, Plate 3, figs. 1 to 4). SÖRENSEN, in his paper "Om Lydorganer hos Fiske," also gives an external lateral view of the air-bladder of *Synodontis* with the object of showing the relations of the

\* These facts suggest that in the mode of formation of the nodular terminal plates of the mechanism *Oxydoras* resembles *Doras*, *Synodontis*, and *Auchenipterus*.

“elastic-spring” mechanism to the walls of that organ. We regret that we have only been able to examine a skeleton of this species, but we venture to give a brief description of certain features in its structure for the sake of comparison with other types. It is interesting to remark that in many of its skeletal details *Synodontis* exhibits a much closer resemblance to the East Indian genus *Pangasius* (e.g., *P. Buchanani*, *P. djambal*) than to those South American Siluroids in which an “elastic-spring” apparatus is present.

The first, the complex (fig. 67, *c.c.*), and the fifth (*v.*<sup>5</sup>), and sixth (*v.*<sup>6</sup>) vertebræ are rigidly connected together by investing superficial ossifications which continuously thicken the ventro-lateral surfaces of their centra, and terminate in front at the anterior end of the complex centrum in strong oblique lateral ridges that overlap the basioccipital, or rather articulate with its thickened ventral portion by an interdigitating suture. The true body of the first vertebra is therefore not visible externally on the ventral surface. There is a deep aortic groove (*a.g.*). Stout radial nodules (*r.n.*) are attached to the oblique lateral ridges of the complex centrum, and fairly broad dorsal laminae (*d.l.*) extend therefrom ventrad to the cardinal grooves, and blend with the ventral surfaces of the posterior divisions of the transverse processes of the fourth vertebra. Unlike *Auchenipterus*, *Doras*, and *Oxydoras*, each of these processes in *Synodontis* is deeply cleft into anterior and posterior divisions, of which the latter (*tp.*<sup>4p.</sup>) is directed obliquely backwards and acutely pointed at its free distal extremity, while the former is modified to form an “elastic spring” mechanism. The anterior division (*tp.*<sup>4a.</sup>) has an oblique origin from the arch of the complex vertebra, continuous behind with the flat but much stouter root of the posterior division, and, after extending slightly forwards, and, at the same time, curving downwards, becomes bent backwards on itself, and expanded into a flattened and somewhat semi-circular plate, the posterior surface of which is directed backwards and a little upwards (fig. 67). The anterior face of the plate is strengthened by a stout projecting process which extends forwards and upwards over the inferior limb of the post-temporal (*pt.i.*), and probably serves for the insertion of the protractor muscle of the mechanism. From their position and the direction of their faces these plates must have been applied to the lateral portions of the anterior wall rather than to the antero-lateral or lateral walls of the anterior chamber as is the case with *Auchenipterus*.\* The transverse processes of the fifth vertebra (*t.p.*<sup>5</sup>) articulate with the basal portions of the posterior divisions of the preceding processes by irregular interdigitating sutures, but otherwise form long triangular structures, directed obliquely

\* With regard to the terminal plates of the mechanism and their relations to the wall of the anterior chamber, it will be seen from the following extract from SÖRENSEN'S more recent paper (37, p. 140), that *Synodontis* closely agrees with *Doras*:—“Chez le genre *Synodontis*, le disque peu épais du ressort est une ossification de la couche externe de la membrane externe; la couche interne est ici assez mince et s'étend le long de la face interne (postérieure) du disque, dont elle est séparée par une masse épaisse gélatineuse d'une nature particulière.”

backwards and pointed at their free distal extremities. Those belonging to the sixth vertebra (*t.p.*<sup>6</sup>) are widely separated from the foregoing, and carry the first pair of ribs. As the transverse process of the fourth vertebra contributes nothing to the support of the pectoral girdle, the inferior limb of the post-temporal (*pt.i.*) is unusually massive, and articulates internally with an equally stout outgrowth from the lateral surface of the basioccipital. For the same reason, and as in *Auchenipterus* and *Oxydoras*, the ascending process of the same bone has an extensive and intimate articulation with the dermal nuchal plates, and with the skull.

The tripus is normal. The crescentic process (*tr.c.*) rests upon the flexible root of the "elastic-spring" of its side, and describes a somewhat sharp, inward, and downward curvature along, and in contact with the contiguous lateral surface of the complex centrum. The posterior margin of the process is deeply grooved for the attachment of the converging fibres of the dorsal wall of the anterior chamber, while its ventral surface is traversed by an exceptionally well-marked ventral ridge. The depth of the groove and the strength of the ridge suggest that the air-bladder of this species is furnished with unusually stout walls. It is not so obvious as in *Auchenipterus* and *Oxydoras* that the movements of the tripodes in *Synodontis* can, to any great extent, be limited or controlled by the action of the "elastic-spring" apparatus. Except that the ascending process is very short the scaphium is normal. The intercalarium is a small oblong nodule in the usual position.

#### GROUP :—RHINOGLANINA.

##### *Callomystax gagata.*

In this Indian Siluroid, we again meet with an example of that abnormal type of air-bladder in which the organ is longitudinally constricted into two simple lateral air-sacs, and more or less completely enclosed within bony capsules formed by the modified transverse processes of certain of the anterior vertebræ. But although *Callomystax* bears a general resemblance to such Siluroids as *Glyptosternum*, *Bagarius*, and others, in these respects it is, nevertheless, not without certain noteworthy peculiarities of its own. It is this species that possesses the peculiar modification of the confluent spinous processes of the fourth and fifth vertebræ, and the first and second interspinous bones of the dorsal fin to form a stridulating mechanism, which has already been described by one of us.\* Beyond a brief reference to the air-bladder by DAY (9), who includes the genus under the name *Gagata*, in his list of those Indian Siluridæ, in which the organ is said to be partially or completely surrounded by bone, we are not aware of any recorded observations.

The complex and fifth vertebræ are rigidly connected with each other by the

\* A. C. HADDON, "On the stridulating apparatus of *Callomystax gagata*."—'Journ. Anat. and Physiol.,' vol. 15, p. 322 (17A).



anachylosis of their neural arches and spines, and also with the skull by the firm sutural union of the arch and spine of the third vertebra with the supraoccipital and the exoccipitals, and by a similar union of the transverse processes of the fourth vertebra with the post-temporals. The body of the first vertebra (fig. 70, *v.*<sup>1</sup>) is unusually small, being represented by a thin discoidal bone firmly wedged in between the basioccipital and the complex centrum. Its ventral surface is visible externally, but dorsally the centrum is partially excluded from the floor of the neural canal by the conjoined margins of the complex centrum and basioccipital. The complex centrum (*c.c.*) is more than twice the length of the centrum of the fifth vertebra (*v.*<sup>5</sup>), which in turn is but a little larger than one of the succeeding free normal centra. The sixth vertebra is normal and freely movable on the foregoing. Owing to the width of the intervertebral ligament between the fifth and sixth centra, and the complete freedom of the arch and spine of the latter, there is considerable lateral and vertical mobility between the sixth and remaining trunk vertebræ and the fifth and preceding vertebræ.

The spinous processes of the third, fourth, and fifth vertebræ (fig. 68, *n.s.*<sup>3</sup>, *n.s.*<sup>4</sup>, and *n.s.*<sup>5</sup>) are confluent, and together form a high, laterally compressed lamina of bone, with an oblique backwardly projecting posterior margin, a dorsal edge which is somewhat rounded behind but slopes downwards in front, and a relatively short anterior margin. The anterior portion of the plate, representing the spine of the third vertebra, is inclined forwards and, with the neural arch with which it is continuous inferiorly, firmly articulates with the supraoccipital and exoccipitals, and also along its dorsal border with a descending process derived from the supraoccipital spine (*s.o.*<sup>1</sup>). The posterior section of the lamina, representing the spines of the fourth and fifth vertebræ, and separated from the anterior by a well marked semicircular notch in the dorsal margin, is longitudinally cleft to its root into two thin opposed plates\* separated by an interval sufficiently wide to receive the modified first and second interspinous bones of the dorsal fin (*i.s.*<sup>1</sup> and *i.s.*<sup>2</sup>). The inner surface of each of the two opposed plates is transversed by a series of closely set, vertically arranged and parallel ridges while the first interspinous bone is similarly ridged on both its surfaces like a double file. The vertical flexure of the sixth and succeeding vertebræ on the anterior rigidly interconnected vertebræ will necessarily cause the ridges on the interspinous bone to scrape against those on the inner surfaces of the cleft neural spines, and therefore probably lead to the production of more or less acute voluntary sounds.

The transverse processes of the fourth and fifth vertebræ combine on each side to form a hollow, transversely disposed and somewhat shallow bony funnel, the mouth of which is slightly expanded and closed only by the lateral cutaneous area of its

\* In the paper on the stridulating mechanism referred to above the two plates are said to be formed by the vertical division of the neural spines of the coalesced anterior vertebræ, but more precisely, and as here stated, they represent the confluent and cleft spines of the fourth and fifth vertebræ.

side, while the somewhat contracted proximal extremity is continuous with the centra and neural arches of the vertebræ in question (fig. 68). The greatly expanded transverse process of the fourth vertebra (figs. 68 and 70, *t.p.*<sup>4</sup>), which forms the greater part of each funnel, is tilted upwards and its anterior margin bent downwards in close contact with the inferior limb of the post-temporal (fig. 70, *pt.i.*), and then backwards, so as almost to meet the anterior edge of the transverse process of the fifth vertebra, thereby forming the anterior and ventral as well as the dorsal walls of the funnel. The recurved lamina forming the incomplete ventral wall (fig. 70, *t.p.*<sup>4</sup>) is extremely thin besides being interrupted by two considerable vacuities which are normally filled in by a thin but tough fibrous membrane. Its outer edge forms the lower lip of the mouth of the funnel (fig. 68), and its inner margin is confluent with the ventro-lateral edge of the complex centrum (fig. 70), so that what is a cleft for the passage of the tripus from the air-bladder to the scaphium, in *Bagarius* and *Glyptosternum*, becomes converted into a complete foramen in *Callomystax*. The bony margins of the two vacuities, as well as the inferior lip of the distal opening of the funnel, have a peculiar indentated or crenulated outline. The posterior margin of the transverse process is also decurved (fig. 68) and articulates by an almost obliterated suture with the dorsal surface of the transverse process of the fifth vertebra (*t.p.*<sup>5</sup>), and, with the latter, forms the posterior wall of the funnel. It will be apparent, therefore, that the transverse process of the fourth vertebra constitutes the dorsal, anterior ventral, and part of the posterior wall of each funnel, while the transverse process of the fifth vertebra completes the posterior wall, and further, that the cavity of the funnel is closed distally by the corresponding lateral cutaneous area, and proximally by the lateral surface of the complex centrum, except at its antero-internal extremity where a small foramen admits of the passage of the tripus from the interior of the funnel to its connection with the scaphium anteriorly. The transverse process of the fifth vertebra (figs. 68 and 70, *t.p.*<sup>5</sup>) is unusually long and massive, with a slight ventral inclination. Its dorsal surface suturally articulates with the decurved posterior margin of the preceding process, but its anterior margin is separated by a vacuity from the ventral wall of the funnel (fig. 70).

The otherwise imperfect ventral wall of each funnel is completed by a thin fibrous membrane which extends between the crenulated margin of the transverse process of the fourth vertebra and the anterior margin of the transverse process of the fifth vertebra, and is also continued across the ventral surface of the complex centrum from one funnel to the other. There is no trace of the peculiar ventral processes of *Bagarius*, *Glyptosternum*, or *Clarias*.

The superficial ossifications do not, to any obvious extent, thicken the lateral surfaces of the centra of the complex and fifth vertebræ, nor do they form an aortic groove or canal, although as a thin layer of bony deposit they obliterate any external indication of the intervertebral suture between the two centra, except on the ventral surface. At the inner extremity of each funnel-shaped recess, and near the inner lip

of the foramen through which the tripus is connected with the scaphium, there is a small radial nodule attached to the lateral surface of the complex centrum. No dorsal laminae could be made out, nor any obvious grooves for the posterior cardinal veins.

The stem and ascending process of each post-temporal (fig. 68. *pt.s.* and *pt.a.*) have a somewhat curved posterior margin which strengthens, and to some extent deepens, the mouth of the funnel at its anterior and dorsal edges. The inferior limb (fig. 70, *pt.i.*) has the usual articulation with the lateral surface of the basioccipital, and for a part of its extent is firmly applied, if not actually ankylosed, to the anterior wall of the funnel. The socket for the clavicle (*cl.s.*) is formed by a groove between the stem and inferior limb of the post-temporal, which is completely closed posteriorly by the distal margin of the anterior wall of the funnel-like transverse process.

As in *Glyptosternum* and *Auchenipterus* the outer surface of each auditory capsule is marked by a deep cup-shaped depression.

The air-bladder (figs. 68 and 70, *a.s.*) is reduced to the condition of two thin-walled, laterally situated air-sacs, which occupy the cavities of their respective bony funnels. Each sac is nearly spherical in shape but slightly contracted at the inner extremity where it is in relation with the tripus. Laterally, the sac bulges outwards into the wider portion of its funnel and has its outer wall nearly, if not actually, in contact with the inner surface of the adjacent lateral cutaneous area.\* In fresh specimens, or when the air-sacs are not shrunken by the action of preservative fluids, it is probable that the two sacs are closely and extensively applied to these areas. Each sac is sufficiently large to be in close contact on all sides, except the outer wall, with the inner surface of its investing bony capsule, but with the exception of the inner wall no fibrous connection between the two could with certainty be made out. In one of our two specimens of *Callomystax* we noticed that the two air-sacs were not symmetrically developed. The one on the right side had extremely thin and almost transparent walls, and appeared also to be somewhat the larger of the two, its outer wall being closely applied to the lateral cutaneous area of its side. The left sac had much thicker and more opaque walls, and, from its smaller size, the outer wall was widely separated from the external skin.

We could discover no communication between the two air-sacs, neither were we able to detect any trace of a ductus pneumaticus.

An examination of the structure of the walls of the two sacs at once shows that in the arrangement of their component fibres, and in the relations of the latter to the tripodes, each sac is substantially similar to the lateral half of an anterior chamber in a normal air-bladder. The crescentic process of the tripus is imbedded in the dorsal wall of the sac near to its anterior and inner extremity, and the fibres radiating from the convexity of the process form, as usual, an inner and an outer stratum. The

\* The antero-posterior extent of each sac was 8 mm., and the width 7.5 mm. The length of the fish itself was 6 inches.

fibres of the outer stratum pursue the normal curvilinear course in passing from the tripus into the dorsal, antero-lateral, and lateral or outer walls; the fibres of the inner stratum have exactly the same attachment and distribution, but radiate directly outwards from the tripus. The two strata are of uniform thickness over the greater part of the dorsal wall of each sac, and together may be taken as representing one of the triangular sheets of a normal anterior chamber, but along a somewhat sharply defined line extending from the posterior or inner extremity of the crescentic process of the tripus, obliquely outwards and backwards to the outer margin of the posterior wall of the sac, the dorsal wall becomes extremely thin, resuming, however, its normal thickness as it subsequently extends downwards to form the posterior wall. This thin area probably corresponds to one half of the thin medio-dorsal portion of the tunica externa in a normal and undivided anterior chamber, and both it and the dorsal edge of the posterior wall appeared to be slightly adherent to the skeleton along an oblique line coincident with the posterior margin of the transverse process of the fourth vertebra. This adhesion of the posterior wall to the skeleton is evidently the equivalent of the dorsal attachment of the primary transverse septum in the normal bladder. The fibres forming the inner wall of each sac are attached dorsally to the feebly developed radial nodule, and, towards the anterior wall, to the ventral surface of the tripus near the root of its crescentic process; these fibres represent what in other Siluroids we have termed the "anterior pillars." Radial fibres converge from the crescentic process to the radial nodule in the usual manner.

The tripus occupies its normal position along the side of the complex centrum; its anterior process, which is much the longest, is connected by a short interossicular ligament with the convex outer surface of the scaphium; the articular process is very slender and directed obliquely backwards to an articular pit on the lateral surface of the complex centrum. Unlike most other abnormal Siluridæ, the crescentic process retains its normal shape and curvature. For the terminal part of its course the process is bent downwards in contact with the side of the complex centrum; the root of the process passes through a foramen at the antero-internal extremity of the osseous funnel, and anteriorly to the foramen gives off the articular process from its inner margin, and is then prolonged forwards as the anterior process. The scaphium consists of spatulate and condylar processes only, the ascending process being entirely suppressed. The spatulate process lies at the bottom of a deep notch in the posterior margin of the exoccipital and, as in *Glyptosternum*, projects so much inwards as to lie on the dorsal surface of the basioccipital within the cranial cavity. The intercalarium is a minute nodule of bone imbedded in the interossicular ligament. We could detect no trace of claustra.

The cavum sinus imparis and its atrial diverticula are certainly normal, and we had no difficulty in detecting a transversely disposed ductus endolymphaticus, but we were unable to arrive at any satisfactory conclusion as to the presence or absence of a sinus endolymphaticus.

From their thinness and partial translucency the lateral and cutaneous areas (fig. 69, *l.c.a.*) are readily noticed in an external view of the Fish. Each area is bounded by, and adherent to, the post-temporal in front, the upper lip of the mouth of the osseous funnel (*t.p.*<sup>4</sup>) above, and the lower lip of the funnel and the distal extremity of the transverse process of the fifth vertebra below. The lateral line canal (*l.l.c.*), with its protective tubular ossicles, crosses the upper margin of each area.

GROUP :—MALAPTERURINA.

*Malapterurus electricus.*

G. ST. HILAIRE and JOHANNES MÜLLER have referred to the air-bladder of this species. The former in his work on Egypt (35) gives a brief description of the external appearance of the organ which he also figures (*loc. cit.*, Plate 12, fig. 4), while MÜLLER (28) simply includes *Malapterurus* among those Siluridæ in which he had found an "elastic-spring" apparatus. SÖRENSEN (36) has also figured the air-bladder, and in a recent paper (37) has described the mode of formation of the terminal plates of the "elastic springs." The promise of an anatomical investigation of *Malapterurus* by the late Professor GOODSIR, referred to by MURRAY in his "Remarks on the Natural History of Electric Fishes" (28A), was fulfilled by Dr. CLELAND (6A).

The complex and fifth vertebræ are firmly connected together by investing superficial ossifications, as well as by the partial ankylosis of their neural arches and spines. Their centra are nearly equal in size, that belonging to the complex vertebra being but a trifle the longer of the two. The body of the first vertebra is very feebly developed in the form of a thin, wafer-like bone, wedged in between the basioccipital and complex centrum. In correlation with the absence of a dorsal fin the anterior neural spines are very short, and none are cleft for the support of interspinous bones. The arch and short spine of the third vertebra (fig. 72, *n.s.*<sup>3</sup>) are inclined forwards towards the supraoccipital and exoccipitals, and connected therewith by a considerable amount of intercalated cartilage. The spine of the fourth vertebra is almost obsolete, and that of the fifth (*n.s.*<sup>5</sup>) is but feebly developed, serving merely to buttress the much stronger spine of the sixth vertebra. The sixth vertebra itself is quite free, both as regards its centrum, arch, and spine.

Each of the transverse processes of the fourth vertebra is cleft to its root into distinct anterior and posterior divisions (fig. 72). The former (*t.p.*<sup>4a</sup>) has an extremely thin but highly elastic root, which grows out from the neural arch of the complex vertebra, and at its origin is slightly oblique in a direction from below upwards and backwards. After a slight ventral flexure the elastic root expands at its distal extremity into a very thin, transversely-disposed oval plate of extremely brittle bone, which is closely applied to the outer portion of the anterior wall of the air-bladder rather than to the antero-lateral region, the two surfaces of the plate looking

directly forwards and backwards respectively. The posterior face of each plate is faintly concave, the anterior very slightly convex. The protractor muscle of this "elastic-spring" mechanism has an origin and an insertion precisely similar to the corresponding muscle in *Auchenipterus*, and the effect of its contraction will be to pull the oval plate directly forwards towards the inferior limb of the post-temporal. The forward movement of each plate is confined within certain definite and comparatively restricted limits by a projecting process of bone which grows out from the anterior surface of the elastic root and extends towards, but without quite reaching, a facet on the anterior margin of the arch of the complex vertebra, immediately in front of the foramen for the exit of the roots of the fourth spinal nerve (fig. 72, *sp.n.*<sup>4</sup>). The forward movement of the plate on the contraction of its protractor muscle (*pt.m.*) will soon bring the process and the facet into direct contact, and any further movement in the same direction will be at once checked. The posterior division of the transverse process (*t.p.*<sup>4</sup>*p.*) is somewhat expanded but not decurved, and its root partially coalesces with the more slender transverse process of the fifth vertebra (*t.p.*<sup>5</sup>). Both processes have their ventral surfaces adapted to the convex dorsal side of the anterior compartment of the air-bladder. The transverse processes of the sixth vertebra (*t.p.*<sup>6</sup>) are long and slender, with short ribs (*r.*<sup>1</sup>) at their distal extremities. It is interesting to remark that, although each of the transverse processes of the fourth vertebra is modified to form an "elastic-spring" mechanism, it differs less from a normal process than is the case with either *Oxydoras* or *Auchenipterus*, and in this respect more closely resembles the only other African Siluroid (*Synodontis*) in which this mechanism is known to exist. Not only does the process retain its characteristic anterior and posterior divisions, but the former more nearly resembles a normal and inelastic anterior division in its relations to the anterior wall of the air-bladder.

Superficial ossifications invest and greatly thicken the sides of the complex and fifth vertebral centra, their free ventral margins forming the lateral boundaries of a well-marked aortic groove. Anteriorly each ossification terminates in a lateral outwardly projecting ridge coincident with the anterior margin of the complex centrum, and at the dorsal extremity of each ridge there is a small but distinct radial nodule suturally attached to the side of the centrum. From each nodule a slender splint-like dorsal lamina passes ventrad to the posterior cardinal vein, and eventually fuses with an oblique outwardly directed ridge on the ventral surface of the posterior division of the transverse process of the fourth vertebra, but for the remainder of its extent the channel for the cardinal vein is a deep groove between the thickened dorsal edge of each superficial ossification and the overlying roots of the transverse processes of the fourth and fifth vertebræ. Posteriorly the superficial ossifications terminate in oblique thickenings, the ventral extremities of which are very similar to accessory articular processes, and overlap the anterior margin of the centrum of the sixth vertebra.

The relatively feeble development of the shoulder-girdle in *Malapterurus*, and the laxity of its connection with the skull, are obviously correlated with the absence of the large pectoral spines which are so characteristic of most other Siluridæ. The post-temporal is but loosely connected with the skull, its ascending process being movably connected with the pterotic and epiotic bones by ligament, while the articulation of the inferior limb with the basioccipital is of a similar character. The clavicular groove is so slight as scarcely to deserve the name of socket, the connection of the clavicle and post-temporal being mainly effected by strong ligamentous fibres.

The air-bladder (fig. 71) consists of two divisions, a relatively small anterior one, which represents a normal bladder, and is divided into an anterior (*a.c.*) and two lateral (*l.c.*) compartments by a primary transverse (*t.s.*) and a longitudinal (*l.s.*) septum; and a somewhat larger posterior sac (*p.c.*), oval in shape, and extending backwards in the abdominal cavity nearly as far as the anus. A contracted tubular portion connects the two divisions, and the longitudinal septum (*l.s.*), which separates the two lateral compartments anteriorly, extends also through the tubular isthmus and the posterior sac, and subdivides the cavity of the latter into a right and left chamber. The posterior sac (*p.c.*) has the shape of a much elongated oval; its walls are moderately thick, but strengthened internally by a number of transversely arranged circular fibrous ridges which project freely into the cavity of each of its chambers. The anterior division of the bladder is somewhat cordate in shape, a deep notch in the median line of its anterior wall partially dividing it into two laterally and forwardly bulging halves. The transverse septum (*t.s.*) is rather narrow, but widens out to some extent before blending with the ventral wall of the bladder. The anterior chamber (*a.c.*) is greatly constricted longitudinally in the median line, first, by the deep notch in its anterior wall, and, secondly, by the unusual prominence of the medio-dorsal ridge which results from the impression of the subvertebral keel; hence it is that the lateral halves of the chamber intercommunicate by a comparatively small aperture. Both the anterior and lateral compartments have relatively thin walls, and the latter exhibit no trace of secondary transverse septa.

In the disposition of the fibres forming the walls of the anterior chamber, and in their relations and attachments to fixed or movable portions of the skeleton, *Malapterurus* differs in no essential feature from *Macrones*. The skeletal insertions of the posterior pillars are shown in fig. 71 (*p.p.*). The dorsal portion of the primary transverse septum (*t.s.*) splits beneath the centrum of the fifth vertebra into two diverging bundles of fibres, which pass dorsally, one on each side of the centrum, and eventually, after curving forwards into the dorsal wall of the anterior chamber, become firmly attached to the lateral surfaces of the complex centrum, to the posterior margins of the dorsal laminae, and to the prolongations of the latter on to the ventral surfaces of the transverse processes of the fourth vertebra. Unlike *Oxydoras* and *Auchenipterus*, the walls of the anterior chamber are not specially thin where the oval plates of the "elastic-spring" mechanism are applied to them. A transverse

membrane, with skeletal attachments in every way similar to those of the corresponding structure in *Auchenipterus*, invests the proper anterior wall of the bladder.

With reference to the mode of growth of the terminal plates of the "elastic-spring" apparatus, SÖRENSEN says (37, p. 140): "Chez le genre *Malapterurus*, le disque mince du ressort n'est pas une ossification de la vessie natatoire (car on peut en suivre la membrane externe le long de sa surface postérieure concave), mais seulement de la plèvre, qui est très épaisse et très ferme en avant, à côté de la partie antérieure de la vessie natatoire." The plates are not, therefore, to be regarded as ossifications of any portion of the tunica externa, but of the transverse membrane only.

The Weberian ossicles require no special description. The scaphium has a long and slender ascending process, in addition to spatulate and condylar processes. The intercalarium is a small nodule of bone in the interossicular ligament. The crescentic process of the tripus curves gradually downwards and inwards from its root towards, and in contact with, the lateral surface of the complex centrum. Claustra are present and occupy their usual position, one on either side of the foramen magnum.

We could detect no deviation from the normal type, either in the structure of the membranous labyrinth of the internal ear, or in the structure and mode of formation of the cavum sinus imparis and atrial cavities.

The dorso-lateral and ventro-lateral muscles of the trunk diverge so slightly that special lateral cutaneous areas can hardly be said to exist.

*Malapterurus beninensis.*

From CLELAND'S account (6A) it may be inferred that this species closely resembles *M. electricus*, except that the intercalarium is said to be absent.

SUB-FAMILY :—**SILURIDÆ ANOMALOPTERÆ.**

GROUP :—HYPOPHTHALMINA.

*Hypophthalmus marginatus.*

RAMSAY WRIGHT (44) has given an account of the air-bladder and anterior vertebræ of this aberrant Siluroid. To admit of comparison with other types, a brief statement of his results may not be out of place, more particularly as *Hypophthalmus* exhibits a remarkably abnormal condition of these structures, and is, moreover, one of the nine genera of Siluridæ in which JOHANNES MÜLLER denied the existence of an air-bladder.

Complete ankylosis has taken place between the conjoined anterior vertebræ from the first to the fifth inclusive. These vertebræ apparently form a "complex," which represents not only the complex vertebræ of other Siluroids, but the first and fifth



as well, and except for a partial intervertebral suture between the fourth and fifth, are indistinguishably fused together. Each of the transverse processes of the fourth vertebra is said by RAMSAY WRIGHT to consist of a dorsal and a ventral\* lamina, the former having its origin from the neural arch and the latter from the centrum of the complex vertebra. The two plates approximate and face posteriorly, but remain widely separated anteriorly so as to enclose a cavity between them which is open distally in the dry skeleton, but closed in front by the bones forming the posterior face of the skull, and encloses the rudimentary air-bladder. Not only are the skull and vertebral column firmly anchylosed together, but the three anterior vertebral centra, that is to say, the first and the anterior portion of the complex, and those parts of the Weberian mechanism usually associated with them, including the claustra, scaphia, intercalaria, the anterior portions of the tripodes, the saccus paravertebralis and the atrial cavities, are telescoped, as it were, on to the upper surface of either the basioccipital or exoccipitals, according as they are median or paired lateral structures, and consequently lie altogether within the hinder part of the cranial cavity. The centrum of the first vertebra is situated on the cranial surface of the basioccipital, within the foramen magnum, and on the dorsal surface of the former are placed the two atrial cavities, excavated in the substance of a thick mass of dura mater, and separated from each other by a median partition of the same material. The roof of the cavum sinus imparis is only partially ossified as a thin plate of bone entirely distinct from the exoccipitals. The floor of the cavum is formed by the basioccipital and exoccipitals, but in consequence of the forward dislocation of all the structures concerned the scaphia form its lateral walls, instead of those of the atrial cavities, as is the case with nearly all other Siluroids.

A complete series of Weberian ossicles is present, including the claustra, but no special description of them is given.

The air-bladder is completely divided into two laterally situated air-sacs, each of which lies in the cavity enclosed by the so-called dorsal and ventral laminae of the corresponding transverse process of the fourth vertebra. Each sac is slightly constricted in the middle, and while the outer half is membranous, the inner is ossified in such a way as to form a bony cup, which is continuous at its outwardly directed free margins with the membranous portion, but at its closed base is confluent with the arch and centrum of the complex vertebra. The osseous half of the bladder is evidently the result of the ossification of the tunica externa, and its subsequent fusion with the wall of the neural canal. Internally the entire bladder is lined with tunica interna. A connection between the hinder end of the tripus and the mem-

\* We have elsewhere given reasons for the belief that the so-called ventral lamina is really no part of the transverse process, but ought rather to be regarded as the equivalent of the ventral process of *Bagarius*, and, like the latter, probably owes its formation to the extension of ossified deposit from the superficial ossifications of the complex centrum into the ventral portion of the superficial coat of the air-bladder. (See Morphological Summary, p. 224).

branous portion of the bladder could still be traced. No communication between the two air-sacs, or between the latter and the œsophagus, was discovered.

Although RAMSAY WRIGHT mentions and figures a transverse ductus endolymphaticus (*loc. cit.*, Plate 9, fig. 10), no reference is made to the presence or absence of a sinus endolymphaticus, and in none of his figures of sections taken through the cavum sinus imparis is that structure represented as present. It would certainly be interesting to know definitely if the omission is really due to the absence of the sinus, for if such be the case *Hypophthalmus* must be included with *Bagarius* and *Glyptosternum* as an additional example of the correlation of retrogressive changes in the air-bladder with degeneration of that portion of the internal ear which is physiologically related to the bladder through the Weberian mechanism.

#### SUB-FAMILY :—**SILURIDÆ PROTEROPODES.**

##### GROUP :—HYPOSTOMATINA.

The only examples of this singular group that we have been able to examine were two badly preserved specimens of *Loricaria cataphracta* and *Plecostomus verres*, and a skeleton of *Callichthys littoralis*. We are therefore only able to confirm the general accuracy of REISSNER'S statements with reference to these genera and to supplement his results on one or two more or less important points. With these exceptions the only other Hypostomatous Siluroid about which anything is precisely known as to the condition of the air-bladder is *Rhinelepis*.

##### *Acanthicus hystrix*.\*

For our knowledge of the air-bladder of this Siluroid we are indebted to REISSNER'S valuable paper (32). The nomenclature adopted by REISSNER is somewhat difficult to follow, and in giving a brief abstract of his paper we shall attempt to correlate the terms employed by him with those used by us so as to facilitate the comparison of *Acanthicus* with other abnormal Siluroids.

Two egg-shaped, thin-walled, osseous capsules are found one on each side of, and confluent with, the "first" and "second" vertebræ.† Each capsule is somewhat broader in front than behind, with a maximum width of 18 mm. and a length of 32 mm. The two capsules occupy the entire width of the anterior portion of the abdominal cavity, and to a large extent superiorly they are invested by, and anchylosed to, the bones which form the posterior part of the cranial shield. The outer and anterior aspect of each capsule is prolonged downwards as a "processus

\* *Rhinelepis acanthicus*, CUV. and VAL.

† According to REISSNER the "second" vertebra carries the first pair of ribs. If these structures are really ribs, the vertebra is either the fifth or the sixth, but if they are merely transverse processes it is probably the fifth. The "first" vertebra is, therefore, a "complex," and includes the first to the fourth vertebræ, inclusive, with the possible addition of the fifth.

auricularis,"\* while the ventral surface a little behind the middle of the capsule is traversed by a deep transverse groove in which the first rib lies. Posteriorly the two capsules are somewhat contracted and terminate in widely separated free extremities. Certain apertures perforate the walls of each capsule. The ventral surface of the anterior and broader portion is fenestrated by several variously sized foramina. A small oval foramen, the "apertura capsulæ osseæ interna inferior," perforates the antero-internal inferior wall. A larger foramen, the ap. cap. oss. externa, traverses the anterior portion of the outer wall immediately below the postero-lateral cranial plates.† One or two channels also perforate the "processus auricularis," and, like all the preceding ones, communicate with the interior of the osseous capsule. From the apertura capsulæ osseæ interna inferior a slight groove extends on to the internal surface of the inner wall of the capsule in a direction upwards and forwards and finally terminates in an "apertura capsulæ osseæ interna superior"‡ through which the interior of the capsule communicates by means of a cavity in the anterior portion of the "first" vertebra with the hinder part of the cranial cavity. From the inner margin of each ap. cap. oss. int. inf. a very delicate process of bone arises, which curves downwards and inwards and meets its fellow of the opposite side, thus forming a slender arch of bone. A somewhat stouter median spicule descends from the ventral surface of the body of the "first" vertebra and fuses with the apex of the arch formed by the two lateral processes. To this peculiar double arch depending from the under surface of the "first" vertebra REISSNER gives the name of "processus bijugus."

The air-bladder is constricted into two laterally situated oval air-sacs which occupy the cavities of the two osseous capsules. The walls of the sacs are everywhere in close contact with the inner surfaces of their investing capsules, but are only attached thereto by a few fibres which are said to transmit blood-vessels and possibly nerves. Although no connection between the two sacs could with certainty be determined REISSNER regards it as extremely probable that such communication does exist, and believes that the tubular connecting duct is supported by the "processus bijugus," § and opens into each air-sac through the "apertura capsulæ osseæ interna inferior."||

\* From the analogy of *Cobitis* REISSNER thinks that this process may represent the distal end of a transverse process; if this be so, it must belong to the fourth vertebra, but much more probably, however, it is the post-temporal.

† This may correspond to the distal aperture of the funnel-shaped transverse process in other abnormal Siluridæ, or possibly to a very similar aperture which is found in each of the outer walls of the osseous capsules of the Cyprinoid *Cobitis* and its allies.

‡ An equivalent to this aperture is found in other Siluroids (e.g., *Callomystax*) at the antero-internal angle of each bony capsule, where there is a foramen through which the tripus passes to its connection with the scaphium anteriorly.

§ From the analogy of *Plecostomus* we have no doubt that REISSNER's belief is correct.

|| There is one point in connection with the air-bladder in which *Acanthicus* is unique among the Siluridæ. REISSNER describes the first pair of ribs as occupying well marked grooves on the ventral

A tripus and a scaphium are described by REISSNER but no mention is made of claustra or intercalaria. The scaphium is a small concavo-convex ossicle without ascending or condylar processes. The tripus has a straight posterior process in addition to the usual anterior and articular processes. For the greater part of its extent each tripus is said to occupy the cavity in the first vertebra through which, according to REISSNER, the cranial cavity communicates with the interior of the osseous capsule. The posterior process of the ossicle, after traversing the "apertura capsulæ osseæ interna superior," gains the interior of the capsule and becomes connected with the air-sac.

The relations of the sinus endolymphaticus and atrial cavities are carefully described. The sacculi are said to lie in two shallow depressions, separated by a slight median ridge on the dorsal surface of the os basilare (basioccipital), in this respect resembling several of the Loricaroid genera, and to be connected by a transverse ductus endolymphaticus. In the absence of figures we are not quite clear as to the exact relations of the sinus endolymphaticus and the atria to the anterior vertebræ and cranial cavity, but as far as we can make out from REISSNER'S description they appear to occupy a Y-shaped groove on the dorsal surface of the basioccipital and the anterior portion of the body of the "first" vertebra, the stem of the Y, which is directed forwards indicating the position of the cavum sinus imparis and the enclosed sinus, while the backwardly and outwardly extending arms indicate the position of the two atrial cavities. In any case we infer that the cavum, like the atria, has only a fibrous roof, and this is apparently also true of the depressions for the sacculi, unless indeed, the latter are freely exposed in the floor of the cranial cavity. The want of the usual bony roof to these cavities or recesses may possibly be due, as we would suggest, to the failure of the exoccipitals to develop their usual horizontal plate-like ingrowths.

*Loricaria cataphracta* and *L. nudirostris*.

Two ill-preserved examples of these species were also examined by REISSNER (32), and, in all essential points affecting the structures under consideration, were found to be in close agreement.

The "first" vertebra is said to be connected with the second by a strongly-toothed suture, and the neural arches of both to possess large "processus spinosi superiores," united by a serrated suture with the "os occipitale superius" (supraoccipital) in the median line. The "first" vertebra is provided with two peculiarly-shaped lateral processes, which REISSNER regards as probably corresponding to modified "processus transversi." Each process is slightly curved in a direction outwards and backwards, and at its proximal extremity encloses a spherical cavity. Externally this cavity

surfaces of the bony capsules. It will follow, therefore, that rather more than a third of the length of the capsules and their enclosed air-sacs must be *dorsad* to the ribs, instead of ventrad to them, and probably project backwards above the ribs into the dorso-lateral muscles.

becomes a deep groove, which is open in front, at all events so far as the transverse process itself is concerned, and gradually dies away towards the distal end of the process. The groove is not an open one, inasmuch as its superior margin joins the inferior edge of the "os occipitale externum" (post-temporal) and its inferior margin the posterior edge of the same bone, so that the groove becomes a closed canal, except that it has a distal aperture between the free edge of the transverse process and the overlapping "os occipitale externum." Near the distal aperture of the canal there is a small area of soft skin, between the cranial plates and those which invest the lateral surface of the trunk.

The cavity enclosed by the proximal portion of the transverse process is separated from the outer groove by a slight ridge, and contains a globose membranous bladder, which, from the analogy of *Acanthicus*, REISSNER rightly regards as equivalent to one-half of the air-bladder. From the inner wall of the cavity of the transverse process a narrow canal extends inwards and forwards, and in this canal lies the almost rectangularly bent tripus.\* This ossicle is said to consist of two processes united at a right angle, and of these one is transversely disposed and connected with the wall of the corresponding air-sac, while the other, or anterior process, projects from the canal in which it is lodged into the cranial cavity, a scaphium similar to that of *Acanthicus* being attached to its free extremity. A membranous canal is said to leave each air-sac and to pass through the hinder wall of the cavity of the transverse process, *probably* for the purpose of effecting a communication with the sac of the opposite side. A perfect "processus bijugus" could not be found, but two osseous processes on the inferior surface of the "first" vertebra, and a slender, bony spicule which is directed inwards and backwards from near the root of each transverse process may possibly represent this structure. Possibly, REISSNER remarks, the spicules, or tendinous prolongations therefrom, may be continuous with the two bony processes.

No reference is made to the internal ear or to the cavum sinus imparis and its atrial cavities.

We are able to supplement REISSNER'S somewhat imperfect description with a few additional particulars.

The "second" vertebra of REISSNER is probably the fifth, and hence, his "first" vertebra really represents the complex vertebra of other Siluroids (see RAMSAY WRIGHT, 44, p. 109). The centrum of the true first vertebra is either wanting, or has fused with the complex, but in the latter case no intervertebral suture could be detected. The posterior face of the complex centrum has a deep tubular concavity, but the almost flat anterior face articulates with the contiguous surface of the basi-occipital by an interdigitating suture. Almost complete fusion, however, has taken place between the arch and spine of the complex vertebra and the supra- and exoccipitals, but from the position of the external atrial apertures, and the mode of articulation of

\* This canal is really a simple aperture between the exoccipital and the arch of the complex vertebra, and corresponds to that portion of the wall of the neural canal which in other Siluroids is fibrous.

the complex vertebra with the basioccipital, it is clear that nothing comparable to the singular forward dislocation of the anterior vertebræ through the foramen magnum and into the cranial cavity, which is so remarkable a feature in *Hypophthalmus*, takes place in *Loricaria*. The bony capsules for the air-bladder are formed by the transverse process of the fourth vertebra in conjunction with certain of the bones forming the posterior face of the skull, viz., the posterior plates of the exoccipitals, the epiotics, and possibly the pterotics, in much the same fashion as in *Hypophthalmus*, except that the post-temporals form the external walls of the capsules and more or less completely close their terminal apertures.

As in *Acanthicus* the sacculi occupy shallow depressions in the cranial surface of the basioccipital, separated by a faint median ridge. It is possible that these structures may have a fibrous roof, but it is certain that they are not invested dorsally by horizontally disposed bony plates derived from the two exoccipitals. We could not with certainty localize the position of the cavum sinus imparis and its atria, but they are probably situated on the dorsal surface of the basioccipital, between the depressions for the sacculi anteriorly, and the apertures whereby the anterior extremities of the tripodes enter the neural canal posteriorly. In that position, and as in *Acanthicus*, there is a slight median depression, which divides behind into two short inconspicuous grooves leading towards the apertures in question, and may possibly indicate the position of these cavities, but if such be the case their walls must be largely fibrous. The scaphia and the anterior extremities of the tripodes project freely into the occipital portion of the cranial cavity, and from the position of the former ossicles it is clear that the external atrial apertures must also be within the cranial cavity, as is the case with such other abnormal Siluridæ as, for example, *Callomystax*. The condition of our specimen was fatal to a satisfactory examination of the internal ear. We were able to ascertain that a very short ductus endolymphaticus is present, but whether a sinus endolymphaticus is present or absent we cannot with certainty say.

The air-bladder has extremely thin but structurally perfect walls. Each lateral air-sac is confined to the more dilated proximal portion of its bony capsule, which, as REISSNER states, is separated from the distal portion by a slight transverse ridge.\* Apart from their connection with the tripodes, which appears to be perfectly normal, the walls of the air-sacs are free from any special attachments to the skeleton or to the inner surfaces of their bony capsules. There is no doubt as to the existence of a connection between the two sacs by means of an extremely slender, thin-walled intermediate canal, which leaves each capsule at the point indicated by REISSNER.

The articular process of the tripus is situated at the point of junction of the anterior and posterior processes, which, as REISSNER states, are united at a right angle. Neither claustra nor intercalaria could be detected.

\* In our specimen each sac was about 3 mm. in length and in width, the length of the Fish being 7 inches.

*Hypostomus verres*, CUV. and VAL. (= *Plecostomus verres*?)

According to REISSNER (32) this species agrees in all important details with *Loricaria*, but has a more perfectly formed "processus bijugus."

These statements we are able to confirm. In the condition of its anterior vertebræ and in the mode of formation of the osseous capsules for the two air-sacs, as well as in the absence of a bony roof to the recess for the sacculi and the cavum sinus imparis, *Plecostomus* closely agrees with *Loricaria*.

We have satisfied ourselves that the "processus bijugus" in *Plecostomus* supports the slender intermediate canal by which the two air-sacs are placed in communication with each other. In this respect *Plecostomus* confirms REISSNER's suggestions as to the object of this singular structure in *Acanthicus*.

We could detect no trace of either intercalaria or claustra.

*Callichthys asper*.

Of this species REISSNER (32) remarks that he had only a very small and badly preserved specimen for examination. In the structure of the cranium and the condition of the "first" vertebra, the air-bladder and Weberian ossicles this Siluroid is said to be more closely allied to *Plecostomus* than the latter is to *Loricaria*. The "processus bijugus" is said to be similar to that of *Plecostomus*, and in connection with its arch REISSNER found a minute canal which, he adds, probably served the purpose of uniting the two divisions of the air-bladder. The tripus is slightly bent, and divides anteriorly into two processes, one for attachment (articular process), and the other for connection with the deeply concave scaphium.

As far as we were able to determine from the external examination of a Museum skeleton of *Callichthys littoralis*, this species closely resembles *Loricaria* in the modifications which the anterior vertebræ undergo, and in the mode of formation of the osseous capsules for the air-bladder, but the union of the vertebral column with the skull seems to be more intimate than in either *Loricaria* or *Plecostomus* (*Hypostomus*).

*Sisor*.

Without reference to any particular species, DAY (9) thus refers to the condition of the air-bladder in this genus:—"Subvertebral bony capsules were present, and apparently contained an air-vessel, whilst none could be detected in the abdomen."

*Pseudecheneis*.

Of this genus the same observer (9) remarks that the air-vessel is "in two rounded lateral portions, and enclosed in bony capsules."

*Exostoma Blythii*, DAY.

Of this Siluroid, DAY (9) says :—" Air-vessel in a globular form, on either side of the body of the anterior vertebræ, and enclosed in bone."

## GROUP :—ASPREDININA.

*Aspredo cotylophorus*.

This South American genus is regarded by COPE (7) as the type of a distinct family (Aspredinidæ) of the order Nematognathi (= Siluridæ). The only reference to the air-bladder of *Aspredo* that we are acquainted with is by CUVIER and VALENCIENNES in their 'Histoire Naturelle des Poissons,' vol. 15, 1840. The air-bladder of "*Aspredo lævis*" (= *A. batrachus*) is there briefly described as composed of two ovoid lobes with fibrous walls of a silvery lustre.

In *Aspredo cotylophorus* the skull, with the first, the complex, and the fifth vertebræ, are immovably connected together. The body of the first vertebra (figs. 73, 74, *v.*<sup>1</sup>) is fairly well-developed, though somewhat smaller than the normal centra, and so obliquely placed, that its anterior and posterior concavities are directed forwards and downwards and backwards and upwards respectively (fig. 74). The complex centrum (figs. 73, 74, *c.c.*) is unusually long and narrow, and is, moreover, so bent upon itself that while its deep and almost tubular posterior concavity looks directly backwards, its cup-shaped anterior face is directed downwards as well as forwards to meet the upturned posterior face of the centrum of the first vertebra (fig. 74). The centrum of the fifth vertebra (*v.*<sup>5</sup>) is almost as long, and its deep tubular anterior concavity is in striking contrast to the relatively shallow posterior concavity. The sixth vertebra (fig. 73, *v.*<sup>6</sup>) is quite free and distinct from the foregoing; its short transverse processes carry the first pair of ribs.

The neural arches of the complex and fifth vertebræ (fig. 74) are almost completely confluent. The coalesced spinous processes of the third and fourth vertebræ (figs. 74, 75, *n.s.*<sup>3</sup>, *n.s.*<sup>4</sup>) are represented by a low, compressed ridge of bone of uniform height, but greatly thickened along its free dorsal margin. The anterior edge of the ridge, with the neural arch of the third vertebra, incline forwards to a firm sutural union with the supraoccipital and exoccipitals, while the posterior margin considerably overlaps, and partially coalesces with, the spine of the fifth vertebra. The latter (*n.s.*<sup>5</sup>) is very strongly developed, inclined obliquely backwards, and cleft for the support of the anterior interspinous bones.

The transverse processes of the fourth and fifth vertebræ (figs. 73 to 75, *t.p.*<sup>4</sup>, *t.p.*<sup>5</sup>) combine to form on each side a narrow wing-like outgrowth, which is much longer than broad, slightly concave from before backwards on its ventral surface, and has its anterior and posterior margins strongly thickened and produced distally into free



projecting processes (fig. 73). The transverse process of the fourth vertebra (*t.p.*<sup>4</sup>) consists of a thickened anterior part which curves downwards, and for a portion of its extent has its anterior face closely applied to the inferior limb of the post-temporal, while its free distal extremity furnishes a posterior wall to the socket for the clavicle. The remainder of the process is a thin narrow lamina of bone, curving at first upwards and backwards, and then slightly downwards to meet a somewhat similar but shorter lamina, derived from the anterior margin of the transverse process of the fifth vertebra. The latter (*t.p.*<sup>5</sup>), in addition to the lamina already mentioned, consists of a long stout process, which has its free projecting extremity connected by a ligament (fig. 73, *lgt.*) with the larger of the two processes, into which the proximal end of the clavicle divides.

Superficial ossifications thicken the lateral surfaces of the complex and fifth vertebral centra, but are interrupted intervertebrally by an irregular interdigitating suture. Their dorsal and ventral edges respectively form the inferior lips of cardinal grooves, and the lateral margins of a median aortic groove (fig. 73). Small radial nodules are suturally attached to the sides of the complex centrum, and a slender spicular dorsal lamina (*d.l.*), with the usual relations to the corresponding cardinal groove, is prolonged from each nodule and blends with the ventral surface of the transverse process of the fourth vertebra.

The post-temporal has the usual three divisions. The slender inferior limb (fig. 73, *pt.i.*) is largely supported by the thickened and decurved anterior portion of the transverse process of the fourth vertebra. Between the inferior limb and the stem of the bone there is a deep groove, which is closed behind by the transverse process, and converted into a tubular socket for the head of the clavicle. The posterior margin of the stem (fig. 75, *pt.s.*) is coincident with, and closely applied to, the similarly curved distal extremity of the same transverse process. The ascending process (*pt.a.*) is very slender, articulating above with the supraoccipital and epiotic, and nearly meeting the pterotic in front. The proximal end of the clavicle is divided into two processes, a slender peg-like process for insertion into the clavicular socket, and a strong triangular outgrowth (*cl'*) which is directed backwards dorsad to the origin of the pectoral fin, and takes the place of the proper posterior process (*cl.p.*) in forming the inferior limit of the contiguous lateral cutaneous area. A strong ligament (fig. 73, *lgt.*) connects the distal extremity of the process with the transverse process of the fifth vertebra.

In consequence of the peculiar flattened condition of the head and the adjacent portion of the trunk in this genus, the extensive lateral cutaneous areas (fig. 73, *l.c.a.*) are situated rather on the dorsal than the lateral surfaces of the body. Each area is peripherally attached to the curved distal margins of the modified transverse processes of the fourth and fifth vertebræ above, in front to the posterior margin of the stem of the post-temporal, and inferiorly, or rather externally, to the clavicular process and to the ligament leading therefrom to the transverse process of the fifth vertebra.

The true posterior process of the clavicle (fig. 75, *cl.p.*), instead of marking the inferior boundary of a lateral cutaneous area, is directed backwards on the ventral side of the body and related solely to the insertion of the ventro-lateral muscles of the body-wall.

The air-bladder (fig. 76, *a.b.*) is partially constricted into two laterally situated and somewhat ovoid or globose sacs by deep emarginations in its anterior and posterior walls.\* Each half of the bladder occupies the shallow bony recess formed by the modified transverse processes of its side. Nearly the whole extent of the lateral or outer wall of each sac, as well as a part of the dorsal wall, are in close contact with the inner surface of a lateral cutaneous area. The opening of the ductus pneumaticus (*d.p.*) is in the medio-ventral line, but nearer to the anterior than the posterior end of the bladder. On removing the ventral wall (fig. 77) it at once becomes obvious that the lateral portions of the organ are in free and open communication with each other, and further, that by far the larger portion of the bladder corresponds to the anterior chamber only of the normally developed structure. A very narrow transverse septum (*t.s.*) is present, but situated so near to the posterior wall that there exists but the barest vestige of a longitudinal septum (*l.s.*), and if lateral compartments can be said to be represented at all it can only be by the postero-internal portions of the lateral halves of the bladder.

In the general structure of the walls of the bladder, which it may be mentioned are extremely thin, and in the nature and extent of its various skeletal attachments, *Aspredo* differs in no essential feature from *Macrones*. The transverse septum is attached dorsally to the ventral surface and sides of the body of the fifth vertebra, and anteriorly and laterally to this to the posterior margins of the dorsal laminae. The anterior pillars are inserted by their dorsal edges into the radial nodules, as well as to the lateral and ventral surfaces of the anterior portion of the complex centrum, and the fibres of the two strata of the tunica externa in converging from the antero-lateral and lateral walls to their attachments to the crescentic processes of the tripodes (*tr.c.*) form the usual well-defined triangular sheets (fig. 77).

The tripus (figs. 73, 77, *tr.*, *tr.c.*) has a short inwardly-curved crescentic process, and a relatively long anterior process. The intercalarium is a very small nodule in the interossicular ligament. The scaphium has no ascending process, but is otherwise complete. The claustra are extremely small spicular ossicles in the usual position.

The recesses for the sacculi are unusually shallow, and the cavum sinus imparis is relatively shorter than in most other *Siluridæ*. The atrial cavities are normal, except that their external apertures and the scaphia which close them, as well as the interossicular ligament, lie altogether within the neural canal on the dorsal surface of the

\* The width of the bladder in our specimen was 17 mm., and the length of each half 10 mm. The length of the Fish was 6 inches.

centrum of the first vertebra. We observed no indications of degeneration in the structure of the internal ear.

At first sight it would seem that, so far as its air-bladder is concerned, *Aspredo*, while more closely resembling the normal Siluridæ than any of the truly abnormal species that we have yet described, nevertheless presents an interesting connecting link between the two extremes. At any rate, this conclusion is suggested by the almost complete suppression of lateral chambers, and the partial constriction of the organ into two laterally situated air-sacs. On the other hand, the air-bladder is by no means small in proportion to the bulk of the Fish; and bearing in mind, also, that there are no obvious indications of retrogression, either in the Weberian ossicles themselves or their connection with the bladder, or in the condition of the internal ear, it seems reasonable to suppose that all these structures are as truly functional as in those species with more typical bladders. It may, therefore, be suggested that such an apparently retrogressive feature in the air-bladder of *Aspredo* as the practical atrophy of the lateral chambers is really related to the peculiarly flattened and shortened condition of the body, and is not to be taken as conclusive evidence of degeneration. At the same time, we admit that the atrophy of the lateral chambers must render the air-bladder and the Weberian mechanism less sensitive as a register of varying hydrostatic pressures.\*

SUB-FAMILY :—**SILURIDÆ HOMALOPTERÆ.**

GROUP :—CLARIINA.

*Clarias nieuhofii.*

TAYLOR (38) has given a brief description of the air-bladder of *Clarias magur* (under the name of *Macropteronotus magur*) to the following effect :—The bladder consists of two small pyriform sacs joined at their pointed extremities by an intermediate canal. The organ is said to lie across the spine, and each of its two pyriform portions to be contained in a funnel-shaped case projecting outwards from the side of the body of the “first” vertebra, and having its mouth covered over by the common integument, as in “*Pimelodus bagharia*” (= *Bagarius Yarrellii*). The case is formed of bone, but above and below by a tendinous membrane that extends across the inferior surface of the first vertebra, thus protecting from pressure the intermediate canal or isthmus by which the two pyriform sacs are united. A communication exists between the air-bladder and alimentary canal by a small ductus pneumaticus passing from the intermediate canal to the œsophagus.

CUVIER and VALENCIENNES (8) refer to a species of this genus under the name of *Clarias hasselquistii* in which the air-bladder is described as being small and formed

\* See Physiological section.

of two rounded lobes, almost entirely separated the one from the other, and sunk in great hollows situated in front of the "apophysis of the large vertebra." These lobes are said to communicate under the body of the vertebra, but from the fact that the bladder had already been displaced, the writer adds that he was not certain how it was attached, and that the ligaments deserve a new and special dissection.

DAY (9) also briefly refers to the air-bladder of *Clarias*, and includes the genus in his list of Siluridæ in which the organ is said to be constricted into two lateral portions, and more or less completely enclosed within bony capsules.

Our own investigations have been confined to *Clarias nieuhofti*, *C. magur*, *C. fuscus*, and *C. anguillaris*.

In *Clarias nieuhofti* the skull and the first, the complex, and the fifth vertebræ are rigidly connected together (i.) by the superficial ossifications which continuously invest the lateral surfaces of the various centra, and also extend on to and thicken the sides and under surface of the basioccipital; and (ii.) through the firm sutural union of the correlated vertebral and cranial elements (figs. 78, 79). The body of the first vertebra (fig. 79, *v.*<sup>1</sup>) is very small; its dorsal surface forms part of the floor of the neural canal, but the ventral and lateral surfaces are covered by the forward extension of the superficial ossifications on to the basioccipital (*b.o.*). In a vertical longitudinal section of this region of the vertebral column the centrum in question appears as if completely enclosed within the contiguous concavities of the complex centrum and basioccipital. The centrum of the complex vertebra (figs. 78, 79, *c.c.*) is nearly three times the length of that of the fifth, and a single pair of fairly large nutrient foramina are visible on its ventral surface. Except for the asymmetrical development of its concavities, the anterior being much deeper than the posterior, the body of the fifth vertebra (*v.*<sup>5</sup>) in no way differs from the normal centra. The sixth vertebra is normal and free (fig. 80, *v.*<sup>6</sup>), but, unlike most other Siluridæ, its well-developed transverse processes do not carry ribs, the seventh (*v.*<sup>7</sup>) being the first of the rib-bearing series.

The confluent spinous processes of the third and fourth vertebræ (fig. 79, *n.s.*<sup>3</sup>), *n.s.*<sup>4</sup>), form a thin vertical plate of bone which is much higher behind than in front. The low, but much-thickened anterior margin of the plate, and the neural arch of the complex vertebra incline forwards, so as to abut against the supraoccipital and exoccipitals, a small amount of intercalated cartilage, however, still persisting between the apposed elements. A thin lamina of bone derived from the under surface of the supraoccipital spine (*so.*<sup>1</sup>) firmly articulates by an interdigitating suture with the dorsal margin of the confluent spines. The uncleft spine and arch of the fifth vertebra (*n.s.*<sup>5</sup>) are firmly, but by suture only, united to those of the preceding vertebra. As in nearly all other Siluroid Fishes, the walls of the neural canal are fibrous over a somewhat triangular area (*at.a.*) on each side between the arch of the complex vertebra and the exoccipital (fig. 79).

The transverse processes of the fourth and fifth vertebræ are greatly expanded and so modified as to form on each side a more or less complete bony funnel, which is

contracted proximally and expanded distally, and has its long axis disposed at right angles to the axis of the body (fig. 78). Except at its root, which is nearly flat, the transverse process of the fourth vertebra (*t.p.*<sup>4</sup>) has the anterior margin curved downwards towards the ventral surface, and of this decurved portion the mesial part is prolonged backwards as a somewhat triangular lamina of bone to form a partial floor for the osseous funnel. Near the flat root of the process the decurved anterior margin abruptly ceases, and leaves a cleft between its free inner edge and the lateral surface of the complex centrum, through which the tripus passes backwards from its connection with the scaphium to gain the interior of the funnel. The posterior margin of the process is but slightly decurved except at its outer extremity, where a slender process of bone curves downwards, and forms the posterior lip of the distal aperture of the funnel. The transverse process of the fifth vertebra (*t.p.*<sup>5</sup>) is comparatively slender, with a flat root and an anterior margin which is suturally united to the posterior edge of the preceding process in the roof of the bony funnel. The distal half of the process, however, has its hinder margin bent downwards and also a little forwards, to meet the recurved anterior edge of the preceding transverse process in the floor of the funnel, and finally ends in a somewhat irregular indentated edge. In this way the transverse process of the fourth vertebra furnishes the anterior and dorsal walls of the funnel and a partial floor, and, in addition, the posterior lip of its terminal aperture, while the corresponding process of the fifth vertebra forms the incomplete posterior wall. So far as the transverse processes are concerned, the bony walls of each funnel are incomplete, both proximally and distally, on the ventral and posterior surfaces; proximally, however, the floor is to some extent completed by a thin, flattened, and tapering process of bone (*v.p.*), which grows out from each of the two lateral ridges bounding the median aortic groove in the region of the complex centrum, and extends outwards to the point where the recurved margins of the two transverse processes nearly meet in the floor of the funnel. This process is clearly the greatly enlarged representative of the ventral process of *Bagarius* and *Glyptosternum*, to which attention has already been directed. Immediately behind the origin of these processes the two lateral aortic ridges are deeply emarginate, to admit of the passage of the median and tubular portion of the air-bladder across the ventral surface of the complex centrum from one lateral air-sac to the other. The anterior margin of the flat root of the transverse process of the fourth vertebra may be traced forwards along the external surface of the neural arch of the complex vertebra in the form of a longitudinal ridge, which finally ceases near the upper lip of the external atrial aperture. A somewhat similar, but more extensive, ridge (*l.r.*), apparently a local thickening of the superficial ossifications of the complex centrum, may also be traced from the lower lip of the atrial aperture obliquely backwards and upwards along the side of the centrum, where it is situated ventrad to the previous ridge, and then curves outwards across the ventral surface of the root of the transverse process of the fourth vertebra, ultimately dying

away along the line of junction of the latter with the transverse process of the fifth vertebra in the roof of the bony funnel. As the two ridges traverse each side of the complex vertebra they enclose between them a well-marked groove, the anterior end of which coincides with the position of the external atrial aperture, while the posterior extremity opens into the proximal portion of the cavity of the funnel; this groove lodges the anterior portion of the tripus (*tr.*), and, at about the middle of its extent, deepens into a pit on the side of the complex centrum for the reception of the articular process of the same ossicle. It may be remarked that the groove is almost an exact repetition of the one already described in *Bagarius Yarrellii*, both as regards its mode of formation and contents, while the ridge, which forms its ventral boundary, we identify in each case as the equivalent of the oblique lateral ridge of the complex centrum in the more normal Siluridæ.

Superficial ossifications thicken the sides, and more especially the ventro-lateral margins of the complex and fifth vertebral centra, and also form the lateral boundaries of a median aortic groove; in addition, they invest the lateral and ventral surfaces of the body of the first vertebra and the basioccipital, including the junction of the former with the complex centrum, so that the first intervertebral suture, which is visible on the ventral surface, is the one between the complex and fifth centra (fig. 78). The dorsal lamina of other Siluridæ is represented in *Clarias* by a thin and somewhat flexible process of bone (*d.l.*) which appears to become detached from the oblique lateral ridge of the complex centrum (*l.r.*) at the point where the latter passes on to the ventral surface of the transverse process of the fourth vertebra, and from thence extends obliquely downwards, inwards, and a little forwards towards, but without quite reaching, the lateral surface of the complex centrum, eventually terminating in a thickened and somewhat hook-shaped free extremity (*r.n.*). Traced outwards from its nodular free extremity along the roof of the funnel the dorsal lamina becomes confluent with the oblique lateral ridge, but may, nevertheless, be traced as a faint flattened projection, with a ridge-like posterior margin, extending along the hinder edge of the transverse process of the fourth vertebra as far as its distal extremity. There can be no doubt that the hook-shaped extremity of the lamina (*r.n.*) corresponds to the radial nodule of other Siluridæ, inasmuch as it receives the insertion of the radial fibres of the tripus (fig. 81), but, instead of being firmly adherent to the side of the complex centrum, the nodule has become detached therefrom and fused with the inner or free extremity of the dorsal lamina. The anterior extremity of the mesonephros passes forwards between the free portion of each dorsal lamina and the complex centrum, across the flat roots of the modified transverse processes, and the posterior cardinal vein takes a precisely similar course on its way to join the Cuvierian duct of its side. Such other local developments of the superficial ossifications as the oblique lateral ridges of the complex centrum and the ventral processes have been already described.

In the arrangement of the foramina for the exit of the anterior spinal nerves from

the neural canal, as well as in the peripheral distribution of the nerves themselves, *Clarias* agrees very closely with *Macrones* (fig. 79).

The post-temporal has only a vestige of an inferior limb (fig. 78, *pt.i.*) which is firmly applied to the distal portion of the anterior wall of the bony funnel of its side, but remains widely separated from the basioccipital (*b.o.*). The expanded stem of the bone (*pt.s.*) is directly continuous with the ascending process (*pt.a.*), and is also traversed on its inner surface by a groove (*cl.s.*) for articulation with the proximal extremity of the clavicle. A backwardly projecting process from the stem (*pt.s.*) is closely applied to the distal extremity of the transverse process of the fourth vertebra in such a way as to encircle the anterior and dorsal lips of the distal aperture of the funnel, the dorsal wall of which is also slightly lengthened, but without in any way closing or diminishing the size of the terminal aperture. Between this process and the outer margin of the roof of the funnel there is a foramen for the transmission of the lateral-line branch of the tenth cranial nerve as it passes backwards from the skull after traversing the dorsal surface of the funnel (*x'*).

The cavum sinus imparis (fig. 79, *c.s.i.*), the foveæ sacculi (*f.s.*), and the atrial cavities and their external apertures (*at.a.*) differ in no essential feature, either as regards mode of formation, relative size, or mutual relations, from the corresponding structures in *Macrones*, or any other normal Siluroid.

Before dealing with the structure of the air-bladder brief reference may be made to certain investing membranes and other structures which are closely related to its osseous capsules.

As originally stated by TAYLOR (*loc. cit.*), a thin but tough fibrous membrane completes the walls of the bony funnels wherever vacuities exist between the modified transverse processes, or where they are otherwise incomplete, but is apparently restricted to the anterior ventral and posterior surfaces of the funnels. Mesially, the membrane extends across the ventral surface of the complex centrum and there furnishes a tubular investment to the contracted median portion of the air-bladder; anteriorly, it is continuous with the walls of the saccus paravertebralis (fig. 78, *s.pv.*), and apparently also, after extending forwards over the dorsal surface of the bilobed anterior extremity of the mesonephros, with the aponeurotic membrane separating the abdominal cavity from the pericardial and branchial cavities; laterally the membrane extends over and closes the terminal apertures of the two funnels. The precise nature of this investing membrane is difficult to determine. It may be merely a backward prolongation of the aponeurotic membrane over the funnels, or, as is perhaps more probable, the membrane represents what we have elsewhere regarded as the superficial fibrous coat of the air-bladder, and is indicated in the more normal Siluroids by the transverse membrane, or, in certain abnormal forms, *e.g.*, *Bagarius* and *Glyptosternum*, by an external fibrous investment to the ventral surface of the rudimentary bladder. Whatever may be its nature it is highly probable that the walls of the bony funnels are largely formed by the partial ossification of this

membrane, either through an invasion of ossified deposit extending from originally more normal transverse processes, or, as in the case of the ventral processes, by the ossification of the ventral portion of the membrane in continuity with the superficial ossifications of the complex centrum.

The bilobed anterior division of the mesonephros occupies a recess of corresponding shape, immediately in front of the two funnels, to the anterior wall of which, and to their investing membrane the gland is closely applied.

The peritoneum covers the ventral surface of the mesonephros, and, anteriorly, is continued over the under surfaces of the funnels. Although elsewhere easily separable from the latter, the peritoneum is firmly adherent to the fibrous portion of their walls, along the horizontal median line of their ventral surfaces, or, more correctly, along the interspace between the recurved margins of the transverse processes of the fourth and fifth vertebræ. This attachment seems exactly to correspond to a similar connection between the ventral edge of the transverse membrane and the peritoneum in *Macrones*. Anteriorly to this point the peritoneum invests the ventral surface of the bilobed portion of the mesonephros, and from thence is reflected on to the posterior face of the septum separating the abdominal and branchial cavities, ultimately becoming prolonged backwards on to the dorsal wall of the œsophagus. A little in front of the outer extremity of each funnel the peritoneum grows out through the ventro-lateral muscles, and terminates in a relatively spacious cul-de-sac, between the funnel and the axilla of the pectoral fin, and immediately beneath the external skin. Each peritoneal sac contains a small diverticulum from the adjacent lateral lobe of the liver, which is connected by a slender stalk with the abdominal portion of the gland. In a somewhat similar fashion a lateral prolongation from the anterior portion of the mesonephros also bulges outwards through the ventro-lateral muscles, and occupies a recess situated just behind the mouth of the funnel and close to the superficial skin, but, unlike the hepatic outgrowths, has no peritoneal investment.

In addition to the fibrous investment which covers the osseous funnels and closes their distal apertures, the latter are also in close relation with lateral areas of the external skin. The lateral-line canal, with two of its tubular ossicles, and the lateral branch of the tenth cranial nerve, cross each area as they pass backwards from the skull.

As far as the shape and general relations of the air-bladder are concerned, TAYLOR'S description (*loc. cit.*) is perfectly accurate. The organ consists of two thin-walled pyriform sacs, which occupy and completely fill the cavities of the two bony funnels (fig. 80, *a.s.*). Each sac is connected with its fellow by a narrow tubular portion which crosses the median line, ventrad to the centrum of the complex vertebra, and also to the aortic groove and dorsal aorta, and, in so doing, traverses deep emarginations in the aortic ridges.\* The walls of each air-sac are everywhere in close contact

\* In a specimen twelve and a half inches long, the length of each sac when measured from the middle of the tubular portion was 15 mm., and the maximum width 6 mm.



with the bony or fibrous wall of its investing capsule, at all events, when the sac has not shrunk from the action of preservative fluids, or collapsed from injury to its walls. The walls of the bladder are composed of an outer fibrous sheet, the tunica externa, lined throughout by a thin delicate inner tunic with an epithelium on its inner surface. A slender ductus pneumaticus passes from the intermediate tubular portion of the bladder to the œsophagus, precisely as TAYLOR described.

Notwithstanding the abnormal condition of the bladder, the general structure of its walls and the extent and nature of its attachments to various skeletal elements are substantially similar to those of an anterior chamber in a perfectly normal organ (fig. 81). The tunica externa of the ventral, anterior, and the greater part of the dorsal wall of each sac is extremely thin, but for a portion of its extent in the posterior wall, is somewhat thickened by the prolongation inwards between the ventral process and the transverse process of the fifth vertebra of a sheet of fibres derived from the fibrous investment of the ventral surface of the funnel which blends with the posterior wall and more or less firmly attaches the latter to the inner surface of the transverse process. In addition to this the dorsal edge of the posterior wall (*p.p.*) is firmly inserted into nearly the whole length of the posterior margin of the dorsal lamina, from the point where the latter becomes apparent as a faint ridge on the inner surface of the transverse process of the fourth vertebra in the roof of the funnel to its free inner termination in the radial nodule (*r.n.*). The median tubular section of the bladder is also attached by its anterior and dorsal walls respectively to the roots of the ventral processes and to the ventral surface of the complex centrum. Such rigid skeletal attachments are strictly comparable to the dorsal insertion of the primary transverse septum into the skeleton, and to the medio-dorsal attachment to the complex centrum, respectively, in a normal anterior chamber. The anterior pillars of the normal bladder are apparently represented in *Clarias* by the dorsal attachment of the inner or mesial portion of the anterior wall of each air-sac to the complex centrum, to the radial nodule, and to the ventral surface of the root of the crescentic process of the tripus, but unlike *Bagarius*, *Glyptosternum*, and some other abnormal Siluridæ, the remainder of the anterior wall is free from any special attachment or connection with the transverse process of the fourth vertebra.

The tripus is an unusually large but extremely thin flattened ossicle (fig. 81, *tr.*). The anterior process (*tr.a.*) is provided with a flattened inner face at its anterior extremity for the attachment of the interossicular ligament. From the junction of the anterior and crescentic processes an articular process (*tr.ar.*) is given off, which, by means of its pointed distal extremity, articulates with the lateral surface of the complex centrum at the bottom of a deep pit-like depression. Both the anterior and articular processes occupy the longitudinal groove on the lateral surface of the complex vertebra and basioccipital, and lie also in a saccus paravertebralis, the latter coinciding in position and in length with the groove itself (fig. 78, *tr.s.pv.*). The root of the crescentic process (fig. 81, *tr.c.*) enters the cavity of the corresponding funnel and

curves slightly outwards into the dorsal wall of the contained air-sac as a thin tapering process of bone, and at its slender, posterior, or outer extremity becomes continuous with the apex of an equally thin, transversely elongated and somewhat triangular lamina, the broad base of which is coincident with, and parallel to, the attachment of the dorsal margin of the posterior wall of the air-sac to the confluent portion of the dorsal lamina (fig. 81). The inner portion of the triangular lamina is a trifle longer than the outer, and tapers to a point near the radial nodule, but nevertheless forms with the root of the crescentic process a characteristic concave, or rather angulated inner margin for the attachment of the radial fibres (*r.f.*) passing therefrom to the radial nodule (*r.n.*). The remaining portion of the lamina is directed outwards, like the heel-like process of *Macrones*, and also tapers to a point. The triangular lamina is the only portion of the tripus which is seen imbedded in the dorsal wall of the air-sac when the cavity of the latter is laid open from the ventral surface and the tunica interna removed. We have several times found the lamina quite distinct from the rest of the tripus, but whether normally so, or as the result of accidental fracture, we are unable to say. The slenderness of its connection with the tripus, and the extremely brittle nature of the bone itself, renders it particularly liable to separation by fracture. On the other hand, we have no doubt whatever that in many of our specimens the lamina was really continuous with the tripus, and that it represents the inwardly curved posterior section of a normal crescentic process.

The relations and attachments of the fibres forming the walls of each air-sac to the tripus are certainly more normal than we expected to find them. As previously stated, the inner or mesial portion of the anterior wall of each sac is attached by its dorsal edge not only to the radial nodule, but also to the ventral surface of the tripus, that is to say, to the root of its crescentic process, although the latter has no trace of the ventral ridge which usually marks the insertion of these fibres in the normal *Siluridæ*. From this point outwards the fibres of the inner stratum of the tunica externa (fig. 81, *in.st.*) in the anterior, antero-lateral, and lateral or outer walls, converge in the dorsal wall towards the tripus, and eventually are inserted into the outer margin of the crescentic process from its root to the pointed extremity of its heel-like process. The fibres of the outer stratum of the tunica externa have an almost exactly similar distribution and relation to the tripus, but pursue the usual curvilinear course in passing from their insertion into the crescentic process to the antero-lateral and lateral regions of the air-sac. The straight posterior margin of the crescentic process appears to be free from any special fibrous connection with the walls of the sac, at any rate it is certain that it does not receive the insertion of any of the converging fibres of the dorsal wall, and in this respect the tripus of *Clarias* is somewhat singular. The reason for this may possibly lie in the fact that the posterior margin of the process is almost coincident with the skeletal attachment of the dorsal edge of the posterior wall of the air-sac to the dorsal lamina.

With regard to the remaining Weberian ossicles we could detect no trace of an

intercalarium, and the interossicular ligament was so short that the anterior extremity of the tripus appeared to be almost in direct contact with the outer surface of the spatulate process of the scaphium. The latter ossicle has the usual spatulate and condylar processes, but no ascending process. We could find no trace of claustra.

As far as the grosser features in the structure of the auditory organ are concerned we could detect no indication of retrogressive modification. A transverse ductus endolymphaticus and a sinus endolymphaticus are present, and the latter structure has the usual relations to the cavum sinus imparis and the atrial cavities. The closure of the external atrial aperture is effected in the usual manner by the spatulate process of the scaphium.

*Clarias magur*, *C. fuscus*, and *C. anguillaris*.

These species very closely resemble *C. nieuhofti* in all essential features, and, therefore, require no special description. There is, however, in each species, a fully developed, nodular intercalarium in the interossicular ligament.

*Clarias macracanthus*.

The anterior vertebræ and bony capsules of this species have been figured and briefly described by SÖRENSEN (37, figs. 29, 30), but no special reference is made to the air-bladder, or auditory organ. The Weberian ossicles are also figured (*loc. cit.*, figs. 31*b*, 31*b*), including a small intercalarium in the interossicular ligament.

*Heterobranchus* (sp?).

We have had no opportunity of examining a species of this genus, but as the structure of the dorsal fin is almost the only point of importance in which *Heterobranchus* differs from *Clarias*, it is probable that the air-bladder and Weberian ossicles are much the same in the two genera. The only reference that we have been able to discover is by JOHANNES MÜLLER (28), whose brief description of the air-bladder of *Heterobranchus*, as being enclosed in bone, to some extent confirms our suggestion that it will be found to resemble that of *Clarias*.

GROUP :—PLOTOSINA.

*Plotosus canius*.

In *Plotosus* we again meet with an air-bladder of the normal type and with skeletal modifications of a very simple character.

The body of the first vertebra (fig. 82, *v.*<sup>1</sup>) is free and distinct but small. The complex and fifth vertebræ (*c.c.*, *v.*<sup>5</sup>) are about equal in size and firmly connected

together, their union being due to the close sutural articulation of their respective neural arches, and to the continuous investment of their centra by superficial ossifications. The sixth vertebra (*v.*<sup>6</sup>) is quite free. The spinous processes of the third and fourth vertebræ are distinct except at their roots, and incline forwards and backwards respectively. The rigid connection of the skull with the vertebral column is secured by the intimate articulation of the arch and spine of the third vertebra with the exoccipitals and supraoccipital.

The transverse process of the fourth vertebra has a broad, flat root but distally is cleft into short anterior and posterior divisions (*t.p.*<sup>4a.</sup>, *t.p.*<sup>4p.</sup>), of which the former is bent downwards and flattened antero-posteriorly, while the latter is somewhat expanded in a horizontal plane and angulated at its free distal extremity. The transverse process of the fifth vertebra (*t.p.*<sup>5</sup>) is very similar to the posterior division of the preceding process, and at its root is partially confluent therewith. The succeeding transverse process (*t.p.*<sup>6</sup>) carries the first rib (*r.*<sup>1</sup>), and is quite distinct from the foregoing.

Superficial ossifications invest and considerably thicken the lateral surfaces of the complex and fifth vertebral centra, and by their produced ventral margins form the lateral walls of a median aortic groove. Anteriorly, the ossifications appear to terminate on the ventral surface of the complex centrum, near its junction with the body of the first vertebra, in a vertically disposed fan-shaped ridge, which is cleft in the centre for the transmission of the dorsal aorta (fig. 82, *sv.p.*). Dorsally, the ossifications terminate in a free edge near the roots of the contiguous transverse processes, which forms the inferior lip of a groove for the posterior cardinal vein and the anterior lobe of the mesonephros. On each of the lateral surfaces of the complex centrum, close to the root of the fan-shaped subvertebral process, there is a somewhat elongated radial nodule (*r.n.*), which is but loosely connected with the centrum by fibrous tissue, and also in the same way with a slender spicule of bone (dorsal lamina) that extends outwards beneath the posterior cardinal vein and finally blends with a longitudinal ridge on the ventral surface of the root of the transverse process of the fourth vertebra which forms the dorsal or outer margin of the cardinal groove.

The post-temporal (*pt.s.*, *pt.i.*) is normal and has the usual relations to the distal extremity of the transverse process of the fourth vertebra and the clavicle. The inferior limb (*pt.i.*) has but a slight forward inclination as it passes inwards to its articulation with the basioccipital. There are no post-temporal plates, nor is any portion of the inferior limb in contact with the anterior wall of the air-bladder.

In shape the air-bladder (fig. 83) is a flattened cone, with its broad end directed forwards and firmly buttressed laterally by the anterior divisions of the modified transverse processes, and in the median line, though to a less extent, by the fan-shaped subvertebral process. In proportion to the size of the body, the bladder is fairly large. Internally, it is subdivided in the usual way by a T-shaped arrangement of the primary transverse and longitudinal septa. The transverse septum (*t.s.*) is rather

narrow. The position of its dorsal margin coincides with the commencement of the posterior third of the length of the bladder, but from this point the septum inclines obliquely forwards, so that the relatively small lateral compartments are prolonged for some distance beneath the anterior chamber. The longitudinal septum (*l.s.*) separating the two lateral chambers also extends forwards, gradually diminishing in height along the posterior face of the inclined transverse septum. The lateral edges of the transverse septum are recurved and directed backwards for a short distance parallel to each other and to the longitudinal septum. Between these recurved margins and the prolongation of the longitudinal septum on to the posterior face of the oblique transverse septum, the lateral compartments extend forwards beneath the anterior chamber in the form of two cul-de-sacs, which finally become obliterated when the two septa blend with the ventral wall of the bladder. The anterior chamber (*a.c.*), like the lateral compartments (*l.c.*) has comparatively thin walls, and for a limited portion of their extent its lateral walls are in close relation with the superficial skin. The anterior wall of the chamber is strengthened by a strong, tendinous transverse membrane which has the usual skeletal attachments laterally and dorsally, and in the median line is firmly inserted into the lateral and ventral margins of the subvertebral process. Both the anterior and lateral chambers have perfectly smooth inner surfaces, the latter being devoid of even the rudiments of secondary transverse septa. In the general disposition and skeletal attachments of the fibres forming the walls of the anterior chamber, *Plotosus* very closely resembles *Macrones*.

The scaphium has ascending, condylar, and spatulate processes. The intercalarium is a thin, discoidal nodule of bone in the interossicular ligament. The anterior and articular processes of the tripus are normal, but the crescentic process (figs. 82, 83, *r.c.*) has but a feebly marked oblique ventral ridge, and is somewhat hook-shaped, with an acutely-pointed posterior or inner extremity.

The cavum sinus imparis and its atrial cavities are perfectly normal, and the same may be said of the correlated portions of the membranous labyrinth.

As in *Clarias* the mesonephros gives off a characteristic lateral outgrowth on each side which occupies a recess in the lateral musculature of the trunk, between the external skin and the outer wall of the adjacent lateral compartment of the air-bladder.

*Plotosus anguillaris.*

This species differs in no essential respect from the preceding. The air-bladder is perhaps somewhat broader and deeper in proportion to its length, and its walls much thinner. The forward extension of the lateral chambers beneath the anterior compartment is even more marked than in *P. canius*, inasmuch as they reach the ventral margin of the interior wall of the bladder. From an examination of several young and half-grown examples of this species, it is obvious that the air-bladder does not always

increase in size with the growth of the body, or, at all events, not to an equivalent extent. In specimens of six and twelve inches in length respectively, the bladder was exactly the same size in both cases. The mesonephric diverticula are exceptionally large, and, in conjunction with the lateral lobes of the liver, entirely exclude the outer walls of the anterior chamber from contact with their respective lateral cutaneous areas.

*Copidoglanis albilabris.*

As regards both its air-bladder and skeleton, this species also very closely resembles *Plotosus canius*. In size, however, the bladder is somewhat smaller in proportion to the body, and has much thicker walls. There is considerable individual variation in the size of the organ in this species. In specimens of approximately equal size the air-bladder may be a third larger in some cases than in others, but as a rule any increase or diminution in size mainly depends on the variability of the lateral compartments rather than of the anterior chamber.

*Cnidoglanis megastoma.*

In this species the skeletal modifications differ but little from those of the two preceding genera. The fan-shaped subvertebral process at the anterior end of the complex centrum, and the expanded and antero-posteriorly flattened anterior division of the modified transverse process, are very strongly developed, and form an almost continuous bony support to the anterior wall of the air-bladder. The posterior division of the same process, and the transverse process of the fifth vertebra, are also greatly produced and expanded, and on each side furnish a stout bony investment to the dorsal wall of the anterior chamber. The superficial ossifications extend outwards from the sides of the complex centrum as broad bony laminæ, and eventually become confluent with the ventral surfaces of the modified transverse processes, thus converting the anterior part of the cardinal groove into a complete canal.

The air-bladder is exceptionally well developed, and has large anterior and lateral compartments. Its walls are thick and of a peculiarly lustrous appearance. The primary transverse septum is inclined forwards, although not to so great an extent as in *Plotosus*, and its ventral margin is coextensive with the width of the bladder. In all other features the organ agrees with that of *Plotosus*.

The crescentic process of the tripus is not hooked but broad and thin, and in the terminal part of its rather open curvature is bent downwards and applied to the lateral surface of the complex centrum, reaching almost to the ventral margin of the latter.

## GROUP :—CHACINA.

*Chaca lophioides.*

CUVIER and VALENCIENNES (8) describe the air-bladder of this species as very large, broader than long, and composed of two lobes, situated one on each side of the vertebral column. Its large size may, perhaps, justify the inference that the air-bladder is of the normal type.

## SUB-FAMILY :—SILURIDÆ HETEROPTERÆ.

## GROUP :—SILURINA.

*Saccobranhus fossilis.*

There is a short, but in some respects very inaccurate, description of the air-bladder of this species by CUVIER and VALENCIENNES (8, vol. 15, p. 301). TAYLOR (38) has also briefly referred to the organ as being very similar to that of *Clarias magur*. DAY's account (9) is equally brief: "air-vessel tubular, placed transversely across the body of the anterior vertebræ, where it is entirely enclosed within a bony capsule" (p. 712).

With regard to the osseous capsules in which its diminutive air-bladder is enclosed, *Saccobranhus* presents an interesting gradation between *Clarias* and *Callomystax*, but the bladder itself is almost precisely similar to that of the former genus. The somewhat elongated funnel-like capsules are very similar on the whole, both in shape and mode of formation, to those of *Clarias nieuhofti*. In one or two features, however, *Saccobranhus* closely resembles *Callomystax*. The anterior margin of the transverse process of the fourth vertebra is strongly deflected throughout its entire length, but to a greater extent in its distal two-thirds, where it forms not only the anterior but also the ventral wall of each funnel, and meets behind the deflected and anteriorly-curved posterior margin of the transverse process of the fifth vertebra. As in *Callomystax*, the decurved anterior margin of the first-mentioned process unites internally with the superficial ossification investing the lateral surface of the complex centrum, and consequently converts what in *Clarias* is a mere slit for the passage of the tripus from the air-bladder to the scaphium into a complete foramen. The characteristic ventral processes which in *Clarias* help to complete the ventral walls of the funnels are absent in *Saccobranhus*, unless the slightly-retroverted edges of the lateral ridges bounding the aortic groove may be regarded as rudiments of them. The two funnels will therefore have complete bony walls except over a small area in the proximal portion of the ventral surface, and distally where they are closed only by the lateral cutaneous areas. The passage for the posterior cardinal vein (cardinal groove) is well marked on the right side, and, anteriorly both the vein and the slender

anterior continuation of the mesonephros traverse a foramen in the anterior wall of the funnel situated ventrad to that which transmits the tripus. On the left side both the groove and foramen are very feebly developed. In the proximal portion of the right funnel there is a short dorsal lamina passing from the ventral surface of the transverse process of the fourth vertebra, ventrad to the cardinal groove, to unite with a well-marked radial nodule, but the latter is in close contact with the lateral surface of the complex centrum, and is somewhat loosely united thereto by fibrous tissue. On the left side, through the narrowness of the cardinal groove, the dorsal lamina is very short, and, with the radial nodule, is firmly attached to the side of the complex centrum.

In shape and structure, and in the nature and extent of its attachments to the walls of the osseous capsules and to the tripodes, the air-bladder of *Saccobranchus* closely resembles that of *Clarias*. An intermediate tubular portion connects the two lateral air-sacs, and is in communication with the œsophagus by a ductus pneumaticus.

The scaphium has a very short rudiment of an ascending process in addition to a condylar process. An intercalarium is present in the form of an extremely thin discoidal ossicle, imbedded in the interossicular ligament. The tripus (fig. 83,  $\alpha$ ) has a more normal shape than in *Clarias*, but its crescentic process is an exceptionally thin, wide, curved lamina of imperfectly ossified bone.

#### *Silurus glanis.*

We have but little to add to the description of this species which WEBER gave in his classical memoir, "De Aure et Auditu Hominis et Animalium, Pars i., De Aure Animalium aquatiliium." On Plate V. of this memoir WEBER has given accurate figures of the membranous labyrinth and "ossicula auditus." The anterior vertebræ and their processes are also figured, but as WEBER failed to recognise the fusion of the second, third, and fourth vertebræ to form the "complex" vertebra the nomenclature he applied to them is inaccurate.

Except for the absence of a fan-shaped subvertebral process, *Silurus* closely resembles *Plotosus* in most of the osteological details with which we are now concerned, and also in the condition and skeletal relations of its air-bladder. The latter organ (fig. 84) is well developed, and its walls are fairly thick though somewhat thinner, perhaps, in the anterior chamber than elsewhere. In young specimens of from four to six inches in length the bladder is rather long in proportion to its width, but in older specimens it becomes somewhat broader and relatively shorter, and in the adult assumes the usual conical shape. The transverse septum (*t.s.*) is a narrow but stout vertical pillar of fibres, continuous behind with the longitudinal septum (*l.s.*) between the two lateral compartments. A transverse membrane with the usual lateral and dorsal attachments to the skeleton is closely applied to the anterior wall. A thin



layer of fatty tissue is interposed between the outer walls of the anterior chamber and the lateral cutaneous areas.

The Weberian ossicles are also very similar to those of *Plotosus*, but the crescentic process of the tripus, like that of *Cnidoglanis* is strongly decurved towards its hinder or inner extremity and closely applied to the lateral surface of the complex centrum.

*Silurus cochinchinensis.*

DAY (9) thus refers to the air-bladder of this species: "Air vessel in the abdominal cavity not enclosed in bone." In all probability the organ is perfectly normal and resembles that of *S. glanis*.

*Wallago attu.*

There is no essential difference between this Siluroid and *Plotosus canius* or *Silurus glanis* in the structure of the air-bladder or in the character of the skeletal modification.\*

The anterior division of each of the transverse processes of the fourth vertebra is strongly decurved in relation with the antero-lateral region of the air-bladder as in *Macrones*, but without being prolonged into a crescentic process. Near the distal end of the process there is an elongated concave facet for articulation anteriorly with the post-temporal. There are no subvertebral processes.

In proportion to its width the air-bladder is rather long and somewhat compressed, so that its depth is equal to, if not greater than, its width. The anterior chamber is relatively small, but on the other hand the lateral compartments are very large and extend backwards in the abdominal cavity as far as the transverse processes and ribs of the thirteenth or fourteenth vertebra. The primary transverse septum is a stout, vertical pillar produced into two ridges anteriorly as in *Arius*, which combine to form a single inwardly projecting ridge along the inner surface of the ventral wall of the anterior chamber, and eventually along the median portion of the anterior wall. The longitudinal septum is a tympaniform sheet of fibres somewhat thinner than the remaining walls of the lateral compartments.

The Weberian ossicles closely resemble those of *Cnidoglanis megastoma*.

*Eutropiichthys vacha.*

We have only been able to examine a skeleton of this species (fig. 85), but as our description of the modifications which the anterior vertebræ and their processes

\* The air-bladder of *Wallago* has been referred to by DAY (9) as follows: "Air-vessel of moderate size, situated in the anterior part of the abdomen; on removing its front wall it is found to be divided into two lateral chambers by a longitudinal septum, which, however, has a round orifice anteriorly so as to admit of free communication between the two sides."

undergo in *Schilbichthys garua* (p. 211, fig. 89) will apply with scarcely any alteration to the former, it may perhaps be concluded that we have here a somewhat similar example of a vestigial and degenerate type of air-bladder. DAY (9), in his paper on the 'Freshwater Siluroids of India,' briefly refers to the air-bladder of *Eutropiichthys* in the following terms: "Air-vessel narrow, tubiform, placed transversely across the body of the anterior vertebra, and all but its central portion enclosed in bone, either expanded extremity being within a bony capsule" (*loc. cit.*, p. 713). This description does not give sufficient details to admit of comparison with other types, but taken in conjunction with the characteristic modifications of the anterior transverse processes it supports the conclusion suggested above.

*Cryptopterus micronema.*

With the exception of the two abnormal species, *C. micropus* and *C. hexapterus*, the skeletal modifications in the remaining species of the genus that we examined are almost identical with those of *Callichrous ceylonensis*.\* Perhaps the most striking feature in the different species of *Cryptopterus* is the marked elongation of the caudal at the expense of the abdominal region of the body, which is also accompanied by a corresponding reduction in the number of vertebræ carrying free ribs to three or four, viz., the fifth or sixth to the seventh or eighth, inclusive. The effect of this on the air-bladder is two-fold, and either leads to the backward extension of the organ into the lateral musculature of the tail, or to the assumption of a shortened and almost globose shape.

The large air-bladder of *C. micronema* is on the whole very similar to that of *Callichrous*, except that the anterior chamber is relatively small and faintly bilobed in front, while the lateral compartments gradually contract into a long, tapering, tubular prolongation which, after traversing the short abdomen, extends into the anterior third of the tail, and there lies on the right side of, and in contact with, the hæmal arches, internal to the lateral caudal muscles. The longitudinal septum is also prolonged backwards into this singular cæcal extension, and sub-divides its cavity into two lateral canals which, anteriorly, communicate with their respective lateral compartments. The walls of the bladder are very thin, and on each side, for a limited extent, the anterior chamber is in contact with a blister-like lateral cutaneous area, but this region of the body is not specially translucent.†

The Weberian ossicles, also, are very similar to those of *Callichrous*; the intercalarium has a horizontal process, but no trace of an ascending portion.

\* See p. 206.

† In this and in all the remaining species of *Cryptopterus*, the disposition and skeletal attachments of the fibres forming the walls of the anterior chamber are almost precisely the same as in *Macrones nemurus*.

*Cryptopterus micropogon.*

This species very clearly resembles *C. micronema*. Relatively to the large lateral chambers the anterior one is smaller than in the latter species. The walls of the bladder are much thicker than in most other species of the genus, this is principally due to the greater development of the inner stratum of the tunica externa. The dorso-lateral and ventro-lateral muscles of the trunk diverge so slightly, that the lateral walls of the anterior chamber are entirely excluded from contact with the external skin; the lateral lobes of the liver are also interposed between the two structures. As in *C. micronema* the lateral compartments are prolonged in the form of a tapering caecal diverticulum into the anterior section of the tail. The intercalarium has a flattened expansion in the interossicular ligament, and also a horizontal process which, without forming a proper ascending portion, nevertheless curves slightly upwards into the fibrous wall of the neural canal at its inner or vertebral extremity.

*Cryptopterus limpok.*

In this species the relatively small air-bladder is broadly ovate or almost spherical in shape and about as deep as it is wide, the greatest depth being coincident with the position of the pillar-like transverse septum which occupies the centre of the bladder, and is continuous behind with the comparatively short longitudinal septum. The lateral walls of the anterior chamber are closely applied to the extremely thin external skin. Dr. GÜNTHER (15, p. 40) remarks of this species, that it "appears to have the place behind the head, where the air-bladder is seen through the transparent skin, of a dark colour during life." Unfortunately the intercalarium had been damaged, and we cannot therefore affirm that it is represented by more than an interossicular nodule.

*Cryptopterus palembangensis.*

The walls of the air-bladder, which in this species is otherwise very similar to that of *C. limpok*, are exceptionally thin and diaphanous, and in the lateral regions of the anterior chamber are in contact with large blister-like lateral cutaneous areas, thus rendering that part of the body more than ordinarily translucent.

*Cryptopterus bicirrhis.*

So far as the air-bladder is concerned, this species closely resembles the preceding. The intercalarium, however, not only consists of interossicular and horizontal portions, but the latter curves slightly upwards into the fibrous wall of the neural canal, and there forms a distinct rudiment of an ascending process.

*Cryptopterus micropus.*

We examined two badly preserved examples of *C. micropus* and *C. hexapterus*, but their condition was such that our results are necessarily imperfect, except in so far as the skeletal modifications were involved. Enough, however, could be made out to justify the conclusion that in both species the air-bladder was in an incipient stage of degeneration.

In *C. micropus* the body of the first vertebra is a mere flattened scale, and the complex centrum is but a trifle longer than the centrum of the fifth vertebra. Both the complex centrum and the basioccipital are provided with strong accessory articular processes on their ventral surfaces. A continuous deposit of superficial bone thickens the lateral surfaces of the centra of the complex and fifth vertebræ, which, otherwise, are suturally distinct from each other. There is a deep median aortic groove.

Each of the transverse processes of the fourth vertebra is partially cleft into slightly divergent anterior and posterior divisions. The anterior process has a strong ventral curvature, and a deflected anterior margin, but thins away to a somewhat pointed distal extremity. About the middle of its dorsal surface a strong process grows upwards, and is provided with an outwardly-directed facet for articulation with the post-temporal. The posterior division is directed horizontally outwards and a little backwards, and is also flattened in such a way that its surfaces look obliquely forwards towards the deflected margin of the anterior division, and backwards respectively. The comparatively slender transverse process of the fifth vertebra is partially confluent with the root of the preceding process, but for the greater part of its extent is directed outwards, parallel and slightly ventrad to the latter. In this way there is formed on each side of the complex centrum, a transversely disposed groove, open ventrally and distally, and bounded in front by the anterior division of the transverse process of the fourth vertebra, and behind by the posterior division in conjunction with the transverse process of the fifth vertebra. The sixth vertebra, and not the fifth as in the more normal species of *Cryptopterus*, carries the first pair of ribs.

A radial nodule suturally attached to the side of the complex centrum is present, and also a dorsal lamina in the usual position and with the usual relations to the posterior cardinal vein and the transverse process of the fourth vertebra.

The air-bladder is somewhat reniform in shape, with its long axis transversely disposed and the contour of its anterior wall interrupted by a deep emargination in the median line. The mesial portion of the organ lies across the ventral surfaces of the complex and fifth vertebral centra, but the more laterally situated parts occupy the grooves enclosed by the modified transverse processes, and are widely separated from the external skin. In a specimen five inches long the antero-posterior extent of the bladder was about 6 mm., and its transverse dimension about 10 mm. On

removing the ventral wall it was apparent that the actual cavity of the bladder is even smaller than might be expected from its diminutive external appearance, inasmuch as the posterior half of the organ, which probably represents the partially aborted lateral compartments, is occupied by a close network of anastomosing fibrous bundles. But so far as we were able to determine, and notwithstanding these indications of degeneration, the general disposition of the fibres forming the walls of the anterior half of the bladder, and their relations to the axial skeleton and to the tripodes, are much the same as in the normal species of *Cryptopterus*. A ductus pneumaticus is present and communicates with the anterior section of the bladder.

The crescentic process of the tripus has a rather open curvature, its posterior extremity being directed but slightly inwards towards the complex centrum. The intercalarium consists of an oblong nodule imbedded in the interossicular ligament, and in our specimen was continued internally into what appeared to be the fractured rudiment of a horizontal process. The scaphium is normal, having spatulate, condylar, and ascending processes.

The cavum sinus imparis and the atrial cavities are normal, but we could arrive at no satisfactory conclusion as to the condition of the associated portions of the membranous labyrinth.

*Cryptopterus hexapterus.*

Except in certain minor details the anterior vertebræ and their processes resemble those of *C. micropus*. As in the latter species the transverse processes of the fourth and fifth vertebræ are modified to form on each side of the complex centrum a shallow transversely disposed groove for the reception of the corresponding lateral half of the air-bladder (fig. 86). The anterior division of the transverse process of the fourth vertebra (*t.p.*<sup>4a.</sup>) is shorter and thicker than in *C. micropus*, and, instead of being produced distally into a slender decurved portion, carries the articular facet for the post-temporal at its abruptly truncated extremity. The posterior division (*t.p.*<sup>4p.</sup>) is directed slightly backwards, and, in conjunction with the equally short and thick transverse process of the fifth vertebra, to which it is firmly applied, forms the posterior wall of the groove for the air-bladder. The first pair of ribs is carried by the sixth vertebra. We could detect no trace of a radial nodule or a dorsal lamina.

The air-bladder is similar in shape and general structure to that of *C. micropus*, but much smaller, its transverse extent being 5 mm., and its antero-posterior length 2.5 mm., although in each case the specimens of the two species were of approximately equal length. Its walls are extremely thick, and laterally are widely separated from the superficial skin. The lateral halves of the bladder are in free communication with each other, and also with the central portion of the œsophagus by means of a ductus pneumaticus.

The tripus and scaphium are also similar to those of the preceding species, and the intercalarium has a distinct horizontal process.

*Callichrous ceylonensis.*

This Siluroid bears a general resemblance to *Wallago* and *Silurus* in the structure of its air-bladder and skeleton, but some of the minor osteological details in which it differs from them indicate an approach to the *Macrones* type—a tendency which is, perhaps, better marked in some of the other species of the genus.

The body of the first vertebra is exceptionally well developed, being nearly as large as any of the normal centra that succeed the fifth. A pair of stout accessory articular processes are developed on its ventral surface for articulation with similarly situated processes on the contiguous margins of the complex centrum and basioccipital. The centra of the complex and fifth vertebræ are also of somewhat unusual length, that belonging to the "complex" being about a third the longer of the two, and both are much compressed laterally.

The anterior division of the transverse process of the fourth vertebra is much stouter than the posterior; towards its distal extremity the former carries a concave facet for articulation with the post-temporal, and is then strongly decurved and prolonged into a rudiment of the characteristic crescentic process of *Macrones* and its allies. The transverse process of the fifth vertebra is quite distinct from the foregoing, and about equal in size to the normal processes which succeed it; a slender rib is attached to its distal extremity. It will be noticed that it is the fifth, and not the sixth, vertebra, as in most other Siluridæ, which carries the first pair of ribs.

The superficial ossifications are but feebly developed, and can scarcely be said to appreciably thicken the lateral surfaces of the complex and fifth vertebral centra. Each ossification is interrupted by an irregular wavy suture as it extends over the junction of the two centra. There is a deep groove for the reception of the dorsal aorta. Anteriorly the ossifications thicken somewhat, and appear to terminate in the accessory articular processes of the complex centrum. A slightly elongated radial nodule is suturally attached to each side of the complex centrum, and to a prominence on its dorsal extremity the radial fibres of the tripus are attached. In connection with the thickened dorsal end of the nodule there is a thin spicule-like dorsal lamina having the usual relations to the cardinal groove and the transverse process of the fourth vertebra. There is no proper subvertebral process.

The inferior processes of the post-temporals have no trace of post-temporal plates.

The air-bladder is almost an exact counterpart of that of *Wallago*, and, in correlation with the laterally compressed shape of the body, is narrow, but unusually deep. The lateral walls of its anterior chamber are in close and extensive contact with the lateral cutaneous areas. In the extent and nature of the skeletal attachments of its air-bladder this genus closely agrees with *Macrones*.

The Weberian ossicles very closely resemble those of *Cnidoglanis*. The posterior and inwardly directed portion of the crescentic process of the tripus is not only bent

downwards in contact with the lateral surface of the complex centrum, but is also prolonged slightly forwards to a pointed termination.

*Callichrous bimaculatus.*

The air-bladder, Weberian ossicles and skeletal modifications are precisely similar to those of *C. ceylonensis*. The intercalarium, however, consists of a hook-shaped process imbedded in the interossicular ligament and prolonged horizontally inwards as a slender spicule towards the membranous walls of the neural canal, thus forming a rudiment of the horizontal process of *Macrones*, but there is no trace of an ascending process. The body in the region of the lateral cutaneous areas is partially translucent.

*Callichrous pabo.*

This species is almost identical with the preceding in all points with which we are now concerned.

*Callichrous hypophthalmus.*

This species differs but little from the three preceding examples of the genus. The air-bladder is, however, less elongated and more cordate in shape, and, relatively to the size of the body, somewhat smaller. As in most other species of *Callichrous*, the lateral cutaneous areas are very thin and externally present the appearance of superficial blisters; internally, they are closely applied to the lateral walls of the anterior chamber of the bladder. The extreme thinness and transparency of these areas, and their close relation to the thin-walled anterior chamber, combined with the laterally compressed shape of the fish, have the effect of rendering this region of the body translucent when the animal is held up to the light.

The intercalarium consists of a flattened nodule in the interossicular ligament, which is prolonged horizontally inwards as a slender spicule, and eventually terminates in the fibrous wall of the neural canal, dorsad to the anterior extremity of the complex centrum, and immediately behind the condylar process of the scaphium, but there is no trace of an ascending process.

*Shilbe mystus.*

With the exception of one or two minor features this African Siluroid is in close agreement with *Callichrous ceylonensis*, both as regards the condition of its air-bladder and the general character of the associated skeletal modifications.

The air-bladder is less compressed than in the latter species, and, consequently, is relatively wider and not so deep. The primary transverse septum is thick but of somewhat greater transverse extent. Instead of being thin and tympaniform, the

longitudinal septum is unusually stout, being strengthened by the aggregation of its component fibres into vertically arranged column-like bundles. The lateral and antero-lateral walls of the anterior chamber are somewhat thinner than the rest of the bladder and in close contact with the external skin, but this region of the body is but feebly translucent.

The Weberian ossicles also resemble those of *Callichrous*, except that the intercalarium is a slender horizontally disposed spicule, one extremity of which is bifid and imbedded in the interossicular ligament, while the other ends in the fibrous wall of the neural canal at a point a little dorsad to the anterior margin of the complex centrum.

*Eutropius niloticus.*

This species differs but little from the preceding. Relatively to the size of the body, the air-bladder is perhaps somewhat smaller and has thicker walls, which are not perceptibly thinner in the lateral or antero-lateral regions than elsewhere, neither is the body in any degree translucent in the region of the lateral cutaneous areas. In shape the organ is obtusely conical and somewhat flattened, with the broad end directed forwards. The intercalarium has a slender horizontal process.

*Ailia bengalensis.*

In this interesting Indian Siluroid the air-bladder and the co-related parts of the skeleton exhibit very singular, and in some respects, unique modifications; but the only reference to them with which we are acquainted is by DAY (9), who very briefly described the air-bladder as being very similar to that of his new genus and species *Ailiichthys punctata*, in which the organ is said to be "tubular, placed across the bodies of the anterior vertebræ, and more or less enclosed in bone" (*loc. cit.*, p. 713).

The complex and fifth vertebræ are firmly united together by the ankylosis of their neural arches and spines, as well as through the continuity of the superficial ossifications which invest the lateral surfaces of their respective centra. The sixth vertebra (figs. 87, 88, *v.*<sup>6</sup>) would be quite free but for the partial coalescence of the roots of its transverse processes with those belonging to the fifth vertebra, and carries the first pair of ribs. A deep aortic groove traverses the ventral surfaces of the complex and fifth vertebral centra. The spinous processes of third, fourth, and fifth vertebræ are confluent, and form a thin, vertical and somewhat elongated lamina of bone (fig. 88, *n.s.*<sup>3</sup>, *n.s.*<sup>4</sup>, *n.s.*<sup>5</sup>); anteriorly, the lamina has the usual articulation with the exoccipitals and supraoccipital.

The transverse processes of the fourth and fifth vertebræ (figs. 87, 88, *t.p.*<sup>4</sup>, *t.p.*<sup>5</sup>) are greatly expanded and confluent, forming on each side of the vertebral column a broad wing-like outgrowth. The anterior margin of each outgrowth is bent downwards in close contact with the hinder face of the skull, and the posterior margin is similarly



deflected, but to a less extent (fig. 88). A very similar lateral outgrowth (figs. 87, 88, *v.p.*) is also given off on each side from the ridge bounding the aortic groove, which is nearly equal in extent and parallel to the more dorsally situated lamina formed by the expanded and confluent transverse processes. The anterior margin of each ventral outgrowth curves upwards and meets the deflected anterior edge of the transverse process of the fourth vertebra, in such a way as to form an anteriorly projecting convex surface, which is closely applied to the posterior face of the exoccipital and the adjacent portion of the epiotic. These dorsal and ventral outgrowths enclose between them, on each side, a relatively spacious recess continuous with each other posteriorly beneath the centrum of the fifth vertebra, open laterally in the dry skeleton, but closed in the fresh specimen by the lateral cutaneous area of its side, and terminating in front in a shallow bony cul-de-sac. At the anterior extremity of each cul-de-sac, and on the inner side, near the anterior end of the complex centrum, there is a small oval foramen through which the anterior process of the tripus passes to its connection with the scaphium by means of the interossicular ligament. On each side of the commencement of the aortic groove the ventral outgrowth is perforated by an oval foramen (fig. 87, *sp.n.*<sup>2</sup>, *sp.n.*<sup>3</sup>) for the transmission of the rami ventrales of the second and third spinal nerves, which primarily leave the neural canal between the exoccipital and the arch of the complex vertebra, and, after traversing the bony cul-de-sac, dorsad to the anterior cornu of the air-bladder, pass to their peripheral distribution through the oval foramen in question.

The post-temporal (figs. 87, 88, *pt.s.*, *pt.a.*) has no obviously distinct inferior limb for the usual articulation with the basioccipital, but it is nevertheless possible that the strip of bone disposed transversely between the foramina for the exit of the vagus (fig. 87, X) and the second and third spinal nerves may represent that element, which, presumably, has fused internally with the basioccipital, and posteriorly and externally with the conjoined anterior margins of the ventral outgrowth and the transverse process of the fourth vertebra. The ascending process (figs. 87, 88, *pt.a.*) is greatly expanded and articulates with the supraoccipital, epiotic, and pterotic bones. The stem of the post-temporal (*pt.s.*) curves obliquely backwards and downwards, and is firmly applied to the distal edge of the decurved anterior margin of the transverse process of the fourth vertebra, and to the contiguous distal margin of the ventral outgrowth (fig. 88). The distal margin of the confluent transverse processes above, and the corresponding margin of the ventral outgrowth below, in conjunction with the post-temporal stem in front, form a bony rim which is only incomplete behind, and to this rim the peripheral margins of the lateral cutaneous area of each side are attached. The socket for the clavicle is a deep groove between the post-temporal stem externally and the distal edge of the ventral outgrowth internally.

The air-bladder (figs. 87, 88, *a.b.*, *a.b.*') is a tubular structure of fairly uniform size throughout, and consists of a transverse portion (fig. 87, *a.b.*) lying across the ventral

surface of the body of the sixth vertebra, and also of two lateral cornua (fig. 88, *a.b.*) which extend forwards into the recesses between the modified transverse processes and the ventral outgrowths. Anteriorly, each cornu terminates cæcally in the shallow cul-de-sac, in which each recess ends in front, the entire bladder thus describing a horse-shoe-shaped curve with the concavity directed forwards.\* The walls of the bladder are extremely thick, except towards the anterior extremities of the lateral cornua, where they become comparatively thin. The transversely disposed portion, and the immediately adjacent sections of the lateral cornua, are more or less completely filled by a delicate network of fibrous tissue, which, however, completely disappears towards the thin-walled cæcal extremities. We could detect no trace of any free or open communication between the anterior cæca through the intermediate portion, or of a ductus pneumaticus.

The skeletal attachments of the air-bladder can be more or less closely identified with those of the normal organ when allowance is made for its peculiar shape and curvature. The partially solid, intermediate section of the bladder is firmly attached to the posterior margins of the ventral outgrowths, while the inner wall of each lateral cornu is firmly connected with a thin and somewhat oblique longitudinal ridge of bone which traverses each of the lateral surfaces of the complex and fifth vertebral centra, and terminates anteriorly in a free projecting spicule, situated on the dorsal side of the thin-walled extremity of each cornu. The free spicule in all probability represents the dorsal lamina, and is almost normal in its position and relations; the longitudinal ridge itself may perhaps be regarded as an abnormal development of the oblique lateral ridge of the complex centrum, in which case its extension backwards along the lateral surfaces of the complex and fifth vertebral centra must be due to the curious infolding of the proper anterior wall of the bladder in the formation of its characteristic horse-shoe-like curvature, which has caused the ridge to lie behind, and to become confluent with, the posterior, instead of the anterior, extremity of the dorsal lamina. The hollow thin-walled extremity of each lateral cornu has much the same structure as the lateral half of an ordinary anterior chamber, and into its dorsal wall the crescentic process of the tripus is inserted. It is not possible, however, to identify any special tracts of fibres converging towards the crescentic process from the anterior and lateral walls of the cæcum, but that portion of the dorsal wall which extends from the inner edge of the process to an insertion into the free spicular extremity of the longitudinal ridge, may perhaps be considered to represent the radial fibres of other Siluridæ.

The relations of the ventral outgrowths to the air-bladder suggest that they should be regarded as due to an excessive development of such structures as are represented in a feebler degree by the characteristic ventral processes of *Bagarius*, *Glyptosternum*, and *Clarias*, or more closely perhaps by the bony laminæ which, in such extremely

\* The width of the air-bladder was 2.5 mm., and the length measured along its curvature, 10 mm., the specimen itself being 4½ inches long.

abnormal forms as *Loricaria Callichthys* and *Hypophthalmus* constitute the ventral walls of the bony capsules for the air-bladder. There is no trace of any superficial fibrous investment to the bladder, or of a transverse membrane, in fact, the place of these structures is really taken by the ventral outgrowths which here, as in other instances, may, with some probability, be regarded as due to the ossification of the former.

The tripus is very similar to that of *Glyptosternum*, the crescentic process having so slight an inward curvature as to be almost straight. The intercalarium is a very small nodule of bone imbedded in the interossicular ligament. Except that it has no ascending process, the scaphium is normal.

The cavum sinus imparis and the atrial cavities differ in no essential respect from those of the more normal Siluridæ, but, unfortunately the auditory organ in the only example of this species that we were able to examine was too badly preserved to admit of any reliable results as to its structure being obtained.

#### *Schilbichthys garua.*

In its skeletal modifications this species bears some resemblance to *Cryptopterus micropus*, and also, but in a lesser degree, to *Bagarius*, *Glyptosternum*, and other similarly modified Siluroids. As we have already pointed out, the agreement between *Schilbichthys* and *Eutropiichthys* is very striking. The air-bladder is said by DAY (9) to be "small, somewhat heart-shaped, and closely attached to the bodies of the anterior vertebræ" (*loc. cit.*, p. 709).

The first, the complex, and the fifth and sixth vertebræ are rigidly connected with one another and to the skull. The body of the first vertebra is very small, and inferiorly appears to be completely enclosed within the contiguous concavities of the basioccipital and complex centrum. The length of the complex centrum (fig. 89, *c.c.*) is nearly twice that of the fifth centrum (*v.*<sup>5</sup>), and the latter, in turn, bears about the same proportion to the normal vertebral centra which succeed it. The neural arches of the complex and two following vertebræ are confluent, or, at the most, are only partially separated by faint irregular sutures. The spine of the third vertebra is represented by a thin ridge of bone which thickens anteriorly, and slopes upwards and forwards to its articulation with the supraoccipital and exoccipital; posteriorly, the ridge is continuous with the base of the long and stout spine of the fourth vertebra, which inclines obliquely backwards, overlapping and almost suppressing the spinous process of the fifth and sixth vertebræ. The seventh vertebra (*v.*<sup>7</sup>) is quite free.

The transverse process of the fourth vertebra (*t.p.*<sup>4</sup>) has a broad root, slightly concave on the ventral surface, and a distal half, which is greatly expanded, and has its anterior and posterior margins curved directly downwards in such a way that they form the sides of a short but relatively deep, transversely disposed, bony semi-cylinder, the cavity of which is open distally as well as ventrally in the dry skeleton. In the

fresh specimen, on the contrary, a ventral wall to each semi-cylinder is furnished by a tough fibrous membrane which stretches between, and is attached to, the decurved margins of the transverse process, and is also continued over the ventral surface of the air-bladder, while the distal apertures of the semi-cylinders are closed by the external skin. The transverse process of the fifth vertebra (*t.p.*<sup>5</sup>) is a short flattened process of bone, free proximally but suturally united at its distal extremity to a small projection from the deflected posterior margin of the preceding process. The transverse processes of the sixth vertebra carry the first pair of ribs.

Superficial ossifications (*s.os.*) considerably thicken the sides, and especially the ventro-lateral margins of the complex and fifth vertebral centra, and even overlap the body of the sixth vertebra behind, as well as obscure the centrum of the first vertebra and blend with the basioccipital in front. The ventral edges of the ossifications are not only thickened but flattened out laterally so as to give rise to two longitudinal ridges the free margins of which are directed outwards. These ridges are very similar to the ventral ridges of *Bagarius*, but, while they enclose between them a shallow aortic groove (*a.g.*), do not give rise to even a trace of the ventral processes so characteristic of the last-mentioned Siluroid. There are no obvious grooves for the posterior cardinal veins, nor could we discover any trace of radial nodules or dorsal laminæ.

The post-temporal has a very slender inferior limb (*pt.i.*) which is directed obliquely forwards to its articulation with the basi-occipital, and for the distal half of its length is closely applied to the anterior wall of the semi-cylindrical transverse process. The ascending process (*pt., a.*), is somewhat flattened, and has the usual articulation with the epiotic, pterotic, and supra-occipital bones of the skull. The stem of the post-temporal (*pt., s.*), is deeply cleft into a long outer and much shorter inner process, which enclose between them a socket for the head of the clavicle. The inner of the two processes is firmly applied to the anterior margin of the distal aperture of the bony semi-cylinder of the same side.

In the skull the recesses for the sacculi are exceptionally small, but the cavum sinus imparis and the atrial cavities appeared to be perfectly normal.

The air-bladder (*a.b.*) is broadly ovate in shape and greatly flattened.\* Along its median antero-posterior axis the bladder is perfectly solid, owing apparently to the fusion of its dorsal and ventral walls anteriorly, and to the exceptional thickness of the longitudinal septum posteriorly, and is also moulded and closely adherent to the lateral and ventral surfaces of the complex and fifth vertebral centra, more especially to the flattened-out ventral margins of the superficial ossifications. Laterally to this longitudinal partition each half of the bladder is hollow and rests by its dorsal surface on the roots of the transverse processes of the fourth and fifth vertebræ, and to some extent bulges outwards into the cavity of the corresponding bony semi-cylinder, but

\* In a specimen, eight inches long, the maximum width of the organ was 11 mm., and the length 9.5 mm.

without completely filling the latter, or extending as far as the external skin, while its anterior and antero-lateral margins are supported by the inferior limb of the post-temporal. By these modifications the air-bladder becomes divided into two symmetrical lateral compartments by a broad, solid, and continuous longitudinal partition. We could discover no trace of a ductus pneumaticus, or of any communication between the lateral cavities. A rudiment of a transverse septum (*t.s.*) partially subdivides each cavity into a relatively large anterior moiety, and a very small posterior chamber, which intercommunicate round the free outer edge of the septum, and may be compared, the former to the lateral half of an anterior chamber, and the latter to a rudimentary lateral compartment. The transverse septum is continuous mesially with the thick longitudinal partition, and dorsally and ventrally with the corresponding walls of the bladder. The dorsal edge of the septum is firmly attached to the posterior margin of the root of the transverse process of the fourth vertebra. Notwithstanding its small size and partial encapsulation by bone, the air-bladder has extremely thick walls, composed of densely matted fibres, in which for the most part no very definite arrangement can be made out. Nevertheless, in the comparatively thin anterior portion of the dorsal wall radially arranged (*in.st.*) and curvilinear fibres may be seen, which here, as in the normal Siluridæ, converge from the anterior and antero-lateral walls of each half of the bladder to their insertion into the crescentic process of the tripus (*tr.c.*). Radial fibres may also be seen converging from the inner margin of the crescentic process, and from its ventral ridge, towards the lateral surface of the complex centrum, to which they appear to be directly attached without the intervention of a radial nodule.

The scaphium has no ascending process, but is otherwise normal, and its spatulate process has the usual relations to the external atrial aperture of its side. The intercalarium is a small osseous nodule in the interossicular ligament. The crescentic process of the tripus (*tr.c.*) occupies its normal position imbedded in the antero-internal portion of the dorsal wall of each half of the bladder, but has a very unusual shape. Instead of being curved, as in most Siluridæ, the process is short and broad, somewhat triangular in outline, with the apex directed backwards. The converging fibres of the dorsal wall of the bladder are inserted into a longitudinal ridge on the ventral surface of the process; anteriorly, this ridge is continued forwards to a point near the origin of the articular process, and there receives the insertion of the usual slip of fibres derived from the mesial portion of the corresponding lateral half of the anterior wall of the bladder. The claustra are unusually well developed, and rest by their expanded bases on the dorso-lateral margins of the body of the first vertebra.

*Lais hexanema.*

This Siluroid so closely resembles *Cryptopterus limpok* as regards the shape, structure, and skeletal relations of its air-bladder, that no special description of the

organ need be given. Both the tripus and scaphium are normal, but the intercalarium has no horizontal process and is represented by a small bony nodule in the interossicular ligament.

*Pseudeutropius.*

We have not been able to examine any examples of this genus, which apparently only differs from *Schilbichthys* in the presence of a small adipose dorsal fin, but DAY (9, p. 709) briefly refers to the air-bladder of three species, viz., *P. atherinoides*, *P. murius*, and *P. goongwaree*. In the first-mentioned of these species the air-bladder is said to be of "large size, as wide as the abdominal cavity, and on removing its front wall a longitudinal septum is seen dividing it into lateral portions which, however, communicate anteriorly." The same writer remarks that in some of the larger species, such as *P. murius* (= *Eutropius* (?) *murius*), and *P. goongwaree*, "the air-vessel is larger than in *P. garua* (= *Schilbichthys garua*), and comparatively considerably smaller than in *P. atherinoides*." He also adds that "*P. garua* has the smallest air-vessel amongst the larger species which I have examined." DAY's descriptions are too brief to admit of any inferences being drawn from them, except, perhaps, that the air-bladder of *Pseudeutropius* is of the normal type and exhibits considerable variation in size in different species.

*Pangasius Buchanani.*

In this Siluroid we meet with several interesting features, and notably the reappearance of an "elastic-spring" apparatus, the existence of which in the East Indian genus *Pangasius* has not hitherto been recorded. JOHANNES MÜLLER (28), in his list of those Siluridæ in which he had discovered this mechanism, not only excluded *Pangasius*, but, by implication, if not explicitly, denied its existence in this genus. TAYLOR (38) and DAY (9) have described the air-bladder of *P. Buchanani*, but they also failed to recognise the presence of the mechanism.

The body of the first vertebra is fairly well developed, being visible in the floor of the neural canal, and also on the ventral surface between the complex centrum and the basioccipital (see *P. djambal*, fig. 90, *v.*<sup>1</sup>). The complex and two following vertebræ are rigidly connected together, partly by the superficial ossifications, and partly by the firm sutural union and partial ankylosis of their respective neural arches and spinous processes. The complex centrum is very large, exceeding in length the centra of the fifth and sixth vertebræ taken together (*c.c.*, *v.*<sup>5</sup>, *v.*<sup>6</sup>). The spines of the third and fourth vertebræ are united at their bases by a thin ridge of bone, but are otherwise distinct, the former inclining forwards to its connection with the supraoccipital and exoccipitals through the intervention of a considerable amount of intercalated cartilage, while the latter is directed obliquely backwards, overlapping, and to some extent suppressing, the partially confluent spines of the fifth and sixth vertebræ. The seventh vertebra is quite distinct.

The transverse process of the fourth vertebra is cleft to its root into distinct anterior and posterior divisions. The former (*tp.<sup>4a.</sup>*), as in *Auchenipterus* and *Malapterurus*, has an oblique origin from the neural arch of the complex vertebra, and from thence curves slightly forwards, and at the same time downwards, in the form of a thin and highly elastic lamina of bone, and finally terminates by expanding into an oval plate, the long axis of which is directed from its dorsal extremity downwards, and a little outwards and forwards. The faces of the plate are somewhat oblique, but nevertheless look almost directly forwards and backwards respectively. The posterior face is nearly flat, but roughened by faint longitudinal ridges; the anterior face, on the contrary, is thickened and somewhat convex, more especially near its dorsal edge, where it becomes continuous with the elastic root. The margins of each plate are thin and extremely brittle. The protractor muscle of the plate (figs. 91, 92, *pt.m.*) has an origin similar to that of the corresponding muscle in *Auchenipterus*, and an insertion which coincides with the thickened dorsal part of the anterior face of the plate. As in other Siluroids with an "elastic-spring" apparatus, the spring and its terminal plate are widely distinct from the post-temporal, and in no way contribute to the support of the pectoral girdle. The posterior division of the transverse process (fig. 90, *tp.<sup>4p.</sup>*) is not decurved, but forms a horizontally arranged and somewhat expanded flat plate of bone. The transverse process of the fifth vertebra (*t.p.<sup>5.</sup>*) is similar in shape, but more slender, and at its root slightly overlaps the preceding process. The transverse processes of the sixth vertebra (*t.p.<sup>6.</sup>*) are normal, and to their distal extremities the first pair of ribs (*r.<sup>1.</sup>*) is attached.

The superficial ossifications (fig. 90, *s.os.*) are thickest where they invest the lateral surfaces of the complex centrum, but gradually thin away posteriorly until they are reduced to comparatively inconspicuous ridges along the ventro-lateral margins of the fifth and sixth vertebral centra. Their ventral margins form two longitudinal ridges which enclose between them a well marked groove for the dorsal aorta. On each of the lateral surfaces of the complex centrum there is a short oblique ridge, and at the dorsal extremity of this a short radial nodule (*r.n.*). A dorsal lamina (*d.l.*) is prolonged from each nodule in the form of a thin obliquely disposed strip of bone, which has the normal relations to the cardinal groove (*cd.g.*), and finally blends with the ventral surface of the posterior division of the transverse process of the fourth vertebra.

As in *Auchenipterus* and *Synodontis*, and, for the same reason, the inferior limb of the post-temporal (fig. 90, *pt.i.*) is strongly developed, and has an exceptionally extensive and firm articulation with the basioccipital: the ascending process also has an equally rigid connection with the skull. The posterior face of the inferior limb is slightly hollowed out for the reception of the oval plate of the "elastic-spring" mechanism when the latter is pulled forwards by the contraction of its protractor muscle. Normally a space of about 5 mm. intervenes between the two structures, and through this interval the oval plate moves according as it is pulled forwards by the

contraction of its muscle or returns to its previous position through the elastic recoil of its root on the muscle ceasing to contract.

The air-bladder (figs. 91 and 92) consists of an anterior portion, which is broad in front and oval behind, and corresponds to the whole of a normal bladder, and also of a contracted tubular part extending backwards in the substance of the kidney to within about half-an-inch of the anus. The anterior portion (fig. 91) is divided internally into a short but broad anterior chamber (*a.c.*), and two relatively large lateral compartments (*l.c.*) by the usual primary transverse (*t.s.*) and longitudinal (*l.s.*) septa. The posterior section of the bladder is a simple tubular cæcum (*p.c.*), communicating anteriorly with both the lateral chambers but terminating blindly behind. The walls of the cæcum are strengthened internally by a series of projecting annular ridges, but the longitudinal septum separating the two lateral compartments anteriorly extends into the cavity of the cæcum for only a very short distance. The cavities of the two lateral chambers (fig. 91, *l.c.*) are subdivided and greatly broken up by the formation of numerous secondary transverse septa (*t.s.*<sup>1</sup>), which grow out from the sides of the longitudinal septum and terminate laterally in free concave margins before quite reaching the outer walls of the chambers. The secondary septa are further complicated, and the spaces they enclose additionally sacculated by the growth of numerous root-like bundles of fibres, which extend between the opposed faces of the septa, and from thence into the adjacent ventral wall of the bladder. The primary transverse septum is unusually thick, and the width of its ventral margin but a little less than that of the bladder itself (figs. 91 and 92, *t.s.*). The more contracted dorsal edge of the septum is firmly adherent to the ventral surface and sides of the posterior portion of the complex centrum, and anteriorly to this, on each side, is inserted also into the posterior margin of the dorsal lamina, while the more lateral portions of the septum have their dorsal margins attached to the ventral surfaces of the posterior divisions of the transverse processes of the fourth vertebra.

In the general structure of the walls of the anterior chamber and in the disposition and skeletal attachments of their component fibres *Pangasius* closely agrees with *Macrones* (fig. 92, *a.c.*). A noteworthy feature, however, is the thinness and transparency of its walls over a well defined oval area in each of its antero-lateral regions. The thinness of these areas is due to the extreme tenuity of the tunica externa, each area being mainly formed by the delicate tunica interna, which here, as in other Siluridæ, lines the whole of the interior of the air-bladder, including the camerated lateral compartments and the tubular cæcal appendage. To the external faces of these areas, but without being otherwise than feebly attached thereto by a delicate connective tissue, the oval plates of the "elastic-spring" mechanism are applied. The lateral walls of the anterior chamber are closely related to lateral cutaneous areas (fig. 91, *l.c.a.*), but a thin stratum of fat prevents the two structures from coming into actual contact except perhaps for a very limited extent.

A fairly strong transverse membrane invests the median portion of the anterior



wall of the air-bladder, and, dorsally, is firmly attached to the ventral surface of the anterior end of the complex centrum, to its oblique lateral ridges, and to the dorsal laminae; laterally to this point, on each side, the dorsal edge of the membrane blends with the floor of the saccus paravertebralis, while its outer edge becomes continuous with the inner and ventral margins of the oval plate of the "elastic-spring" apparatus; on the outer edge of each plate, with which it is also continuous, the membrane reappears and finally blends with the ligamentous fibres connecting the post-temporal and clavicle. Dorsally and anteriorly the membrane seems to be partially continuous with the aponeurotic membrane (fig. 91, *ap.m.*), which, after investing the dorsal surface of the anterior section of the mesonephros in the usual manner, and extending over the ventral surfaces of the inferior limbs of the post-temporals and the basioccipital, ultimately becomes continuous with the dorsal extension of the pericardio-abdominal septum. Along its entire ventral margin the transverse membrane is reflected backwards on to the ventral surface of the air-bladder, where it soon ceases to be traceable.

The relations of the oval plates of the "elastic-spring" mechanism to the transverse membrane, combined with the almost complete disappearance of the tunica externa where the plates are applied to the wall of the anterior chamber, suggests that SÖRENSEN'S conclusion as to the mode of formation of the plates in *Synodontis* and *Doras* is equally applicable to *Pangasius*, and that these structures in the last mentioned Siluroid result from the ossification of both the tunica externa and the transverse membrane.

There are certain discrepancies between the brief descriptions of the air-bladder of this species given by TAYLOR and DAY, and that given by us, to which reference must be made. TAYLOR'S account (38) of the bladder of "*Pimelodus pangasius*," HAM. BUCH. (= *Pangasius Buchanani*, CUV. and VAL.), is to the effect that the organ is composed of four or more portions extending in a line from opposite the pectoral fins to near the end of the tail. The first is said to be generally oval, the second pyramidal, and the two last, which run between the caudal portions of the lateral muscles, approach to a cylindrical shape. The numerous septa on its internal surface are described as descending from above downwards in the first portion, in the second they are transversely arranged, but in the posterior ones form a number of irregular cells. DAY'S account (*l.c.*, p. 700) is in the following terms:—"Air-vessel large, extensive, and divided into three portions. The anterior is somewhat heart-shaped, considerably the largest, and extends from the commencement of the vertebral column to nearly opposite the posterior extremity of the pectoral fin. Its remaining portions are narrow, compressed, and continued to opposite the middle of the anal fin, amongst the muscles covering the hæmal spines. It then becomes narrow and reduplicated on itself for a short distance. On removing the front wall of its first or largest portion, its interior is seen to consist of two pear-shaped cavities, the bases of which are inferior and lateral, whilst they coalesce

anteriorly; the whole of the posterior half of this portion is cellular; and so is the small intermediate space between the two uncalled pyriform portions. The two posterior divisions of the air-vessel have valvular shaped folds, partially subdividing its interior." As regards the subdivision of the bladder, the two accounts are neither reconcilable with each other, nor with the description given above by us, and assuming that the specimens examined by DAY and TAYLOR were really examples of *P. Buchanani*, we can suggest no explanation of the discrepancy. Our own specimen was one from Dr. DAY'S collection of East Indian Siluroids, and had been named by him *P. Buchanani*, and we may also add that its characters agreed in almost every detail with the description of this species in the British Museum Catalogue of Fishes (vol. 5, p. 62). It will be noticed, however, that both TAYLOR and DAY agree as to the extension of the air-bladder into the caudal muscles, which was certainly not the case in the specimen examined by us.

The scaphium is normal. The intercalarium is a relatively small nodule in the interossicular ligament without horizontal or ascending processes. The crescentic process of the tripus is somewhat unusually broad and flattened. From its root backwards the process is directed at first slightly outwards, and then curves inwards and downwards in contact with the lateral surface of the complex centrum, and finally in the form of a pointed process, extends slightly forwards along the ventrolateral margin of the centrum towards the radial nodule (fig. 92, *tr.c.*). A ventral ridge traverses the root of the crescentic process, as in *Macrones*, and, anteriorly, receives the insertion of a slip of fibres derived from the mesial portion of the anterior wall of the bladder (fig. 92), and posteriorly the attachment of the fibres converging from the antero-lateral and lateral walls into the dorsal wall of the anterior chamber. Strong radial fibres (*r.f.*) pass from the inner margin of the ridge, and from the concavity of the crescent, to the radial nodule. The crescentic process is in close relation with the ventral surface of the flexible root of the "elastic-spring" apparatus, and it seems to us that the ventral curvature of the latter must restrict the lateral movements of the tripus within very narrow limits, except when the protractor muscle pulls each oval plate forwards, and consequently widens the curvature of its elastic root. Hence, as in *Auchenipterus*, the mobility of the tripus may be to some extent controlled or regulated by the action of the "elastic-spring" apparatus. The claustra are exceptionally large and somewhat triangular ossicles, with their apices extending upwards into the intercalated cartilage, which largely persists between the spinous process of the third vertebra and the exoccipitals and supraoccipital, and their broad bases resting on the lateral margins of the thick mass of fibrous tissue which forms the posterior wall of the two atrial cavities.

In the structure and relations of the auditory organ, and of the cavum sinus imparis and atrial cavities, *Pangasius* closely resembles *Macrones nemurus* and other normal Siluridæ.

*Pangasius djambal.*

In all osteological details (fig. 90) this species is practically identical with *P. Buchanani*, but in the structure of the air-bladder the former presents one or two minor points of divergence from the latter.

The air-bladder of *P. djambal* (fig. 93) consists of an anterior portion subdivided in the usual way into an anterior (*a.c.*) and two lateral (*l.c.*) compartments, and also of a posterior cæcal appendage (*p.c.*). The latter is not tubular, as in *P. buchmanani*, but has the shape of an elongated, flattened, oval structure, and extends nearly to the hinder extremity of the abdominal cavity, being separated from the rest of the bladder anteriorly by a deep constriction; from its posterior end a small cæcal protuberance (*p.c.*<sup>1</sup>) is given off, which is less than half an inch in length, and gradually tapers to a point near the anus. The cavity of the cæcal appendage (*p.c.*) is largely filled up by a network of fibrous bundles, some of which are vertically and others horizontally arranged, the whole forming a coarse trabecular structure and subdividing the cavity into a series of intercommunicating spaces. The network seems to owe its formation to the disintegration of a median longitudinal septum and several secondary transverse septa. In a somewhat similar fashion the longitudinal septum (*l.s.*), and the secondary transverse septa (*t.s.*<sup>1</sup>) of the two lateral compartments are broken up into a series of not very regularly arranged vertical columns, which dorsally and ventrally pay out into root-like bundles and extend into the adjacent dorsal and ventral walls. As far as the tunica externa is concerned these septa are certainly not continuous structures, and hence the spaces they enclose appear to be in direct and free communication with one another. It is possible, however, that the tunica interna may preserve the continuity of the septal elements and the distinctness of the lateral chambers, except of course where the latter are continuous through the anterior chamber, but we are not absolutely certain on this point. Except where the oval plates of the "elastic-spring" mechanism (*t.p.*<sup>4a.</sup>) are applied to the lateral regions of the anterior wall of the bladder, the latter organ has much thicker walls than is the case with any of the other species of *Pangasius* that we examined. Fig. 94 represents the tripus of this specimen.

*Pangasius macronema.*

This species exhibits a general resemblance to the two preceding species in the structure of the air-bladder and the character of its "elastic-spring" apparatus.

The anterior division of each of the modified transverse processes has a slender stalk-like root, which, after a very slight ventral curvature, expands into a large but very thin oval plate. Each plate has its long axis transversely disposed, and its posterior face, which looks directly backwards, is closely applied to the corresponding lateral half of the anterior wall of the air-bladder.

The air-bladder itself has thin walls, and consists of an anterior and somewhat rounded portion, which includes the anterior and two lateral compartments, and in addition also, a posterior much flattened, leaf-like cæcum connected with the foregoing by a short tubular stalk. The cavities of both the lateral compartments and the posterior cæcal appendage are largely occupied by a trabecular network of branching columns of fibres, but the outer portions of the former are comparatively free from such bundles, and communicate in front with the anterior chamber. As in *P. djambal* this network seems to owe its formation to the partial resolution of a series of secondary transverse septa into branching bundles of fibres. The wall of the anterior chamber is not specially thin where the oval plates of the "elastic-spring" mechanism are applied to it, and it may therefore be inferred that, as in *Malapterurus*, according to SÖRENSEN, the plates result from the ossification of the transverse membrane alone, the tunica externa having no share whatever in their formation.

*Pangasius micronema.*

In a specimen from Dr. BLEEKER's collection labelled *P. micronema*, and agreeing in every particular with the description of this species in the British Museum Catalogue of Fishes (vol. 5, p. 63), we noticed one or two features in which it presented a striking contrast to all other species of the same genus that had come under our notice.

Each of the transverse processes of the fourth vertebra (fig. 96) has a broad flat root, which is prolonged distally into distinct anterior (*t.p.<sup>4a.</sup>*) and posterior (*t.p.<sup>4p.</sup>*) divisions, separated from each other by a broad but comparatively shallow cleft. The anterior division (*t.p.<sup>4a.</sup>*) is thick and inflexible, tapering somewhat towards its decurved distal extremity, but is without a trace of the oval plate so characteristic of other species of *Pangasius*; on the contrary, and as in most other Siluridæ not provided with an "elastic-spring" mechanism, the distal portion of the process is applied to, and firmly supports the outer extremity of the inferior limb of the post-temporal (*pt.i.*), and also the inner of the two processes into which the cleft stem of that bone (*pt.s.*) divides in forming the socket for the clavicle (*c.<sup>1</sup>*). Hence, in this species, the transverse process of the fourth vertebra is not modified to form an "elastic-spring" apparatus, but both in shape and in the support which it affords to the post-temporal and pectoral girdle, closely conforms to its normal condition in the great majority of the Siluridæ; and in harmony with this modification, is the fact that the inferior limb of the post-temporal is relatively slender, or at all events is nothing like so massive as in other species of *Pangasius*.

The air-bladder is broadly ovate in shape but rendered slightly bilobed in front through the existence of a deep median notch in its anterior wall. Relatively to the lateral compartments the anterior chamber is very small, and there is no posterior

cæcal appendage. The walls of the bladder are extremely thin. The primary transverse septum is so obliquely placed that, while its lateral portions are vertical and directly-continuous with the ventral wall of the bladder, the median part is inclined downwards and forwards, and does not finally blend with the ventral wall until it almost reaches the inferior margin of the anterior wall. Through the obliquity of the septum, the lateral compartments and the longitudinal septum separating them are prolonged beneath the median portion of the anterior chamber nearly as far forwards as the anterior wall of the latter. The structure and skeletal attachments of the anterior chamber are otherwise perfectly normal. The inner half of each lateral compartment is subdivided by numerous secondary transverse septa, and these, with the root-like bundles which they give off dorsally and ventrally, largely obliterate the cavity of this part of the bladder. The outer portions of the compartments, on the contrary, are comparatively open and freely communicate in front with the cavity of the anterior chamber.

The Weberian ossicles resemble those of other species of *Pangasius*, except that the inner extremity of the crescentic process of the tripus is not prolonged forwards towards the radial nodule in the form of a pointed projection.

*Pangasius juaro.*

This species substantially agrees with *P. macronema* in almost every respect. The flexible root of each "elastic-spring" apparatus (fig. 95, *t.p.<sup>4a</sup>*) is, however, even more slender, and the oval plate in which it terminates exceptionally large and extremely thin. In our solitary specimen there was no posterior cæcum in connection with the normally subdivided portion of the bladder, but, as the Fish had been eviscerated before it came into our possession, it is possible that the cæcum had been removed with the stomach and intestines. From the appearance of the posterior extremity of the bladder we incline to the opinion that a posterior cæcal appendage does normally exist in this as in other species of *Pangasius* in which the "elastic-spring" mechanism is present. In the relative proportions of the anterior and lateral compartments, and in the growth of a trabecular network of branching bundles of fibres in the latter, *P. juaro* closely resembles *P. macronema*.

*Silondia gangetica.*

Our solitary example of this species was a very young specimen about seven inches in length, and was one of the Indian Siluroids given to us by Dr. DAY. The air-bladder has been briefly described by TAYLOR (38) as being very small in proportion to the bulk of the Fish. It is said to lie close to the anterior vertebræ, to be oval in shape, and divided internally into two cavities, each of which, in a Fish weighing eight pounds, was not larger than a hazel nut. There is also a brief reference to the

organ by DAY (9) in the following terms :—“Air-vessel small and placed transversely across the body of the anterior vertebra, where there is a groove to receive its posterior surface ; anteriorly, it has a thick strong fibrous covering. There is a low osseous process from the vertebra giving it protection laterally. The air-vessel itself consists of two small oval portions, having a median connecting tube, and this lateral part is surrounded by osseous or strong fibrous walls” (*loc. cit.*, p. 712). As the species may attain a length of four feet, it is obvious that our specimen was a very immature one, but this fact alone can hardly account for the marked discrepancy between the conflicting statements of these writers, and the results of our own dissections as stated below.

The body of the first vertebra is a thin discoidal bone with but slightly concave anterior and posterior surfaces, and quite distinct from the complex centrum and basi-occipital. The complex and fifth vertebræ alone are rigidly connected together by the superficial ossifications and the partial ankylosis of their neural arches. The sixth vertebra is quite free. The spines of the third and fourth vertebræ form a thin vertical plate of bone with thickened and produced anterior and posterior margins. The anterior margin is inclined forwards and bifid ; occupying the cleft, and connecting the spine with the supraoccipital and exoccipital bones of the skull, is a considerable amount of intercalated cartilage. The posterior margin is inclined obliquely backwards and deeply cleft for the support of certain of the anterior interspinous bones of the dorsal fin.

The flat roof of the transverse process of the fourth vertebra splits distally into an anterior and a posterior division, the former (fig. 97, *t.p.*<sup>4a</sup>) curving downwards and supporting the anterior wall of the bladder, and in front articulating by a well-marked facet with the post-temporal so as to complete the socket for the clavicle. The slender transverse processes of the fifth and sixth vertebræ (*t.p.*<sup>5</sup>, *t.p.*<sup>6</sup>) are widely distinct from the foregoing ; proximally, they are slightly confluent but their distal extremities are quite free. The sixth vertebra carries the first pair of ribs (*r*<sup>1</sup>).

The ventro-lateral margins of the complex and fifth centra are greatly thickened by superficial ossified deposit, which is prolonged ventrally on each side to form the lateral walls of a median aortic groove. The dorsal lamina (fig. 98, *d.l.*) is represented by a slender spicule of bone, which on each side becomes detached from the ventral surface of the transverse process of the fourth vertebra, close to the complex centrum, and, after a slightly oblique course forwards and downwards, ventrad to the posterior cardinal vein of its side, terminates in a free anterior or ventral extremity which receives the insertion of the radial fibres of the tripus.

The air-bladder (fig. 97) has a very unusual structure. In shape it is somewhat reniform, with its long axis transversely disposed and its anterior wall very slightly concave, while its posterior contour is strongly convex.\* The lateral portions of the anterior wall are supported by the deflected anterior divisions (*t.p.*<sup>4a</sup>) of the modified

\* The dimensions of the bladder in our specimen were, width 10 mm., length 9 mm.

transverse processes. There is no divergence of the dorso-lateral and ventro-lateral muscles, and consequently the lateral walls of the bladder are widely separated from the external skin. On removing the ventral wall a thick and almost circular pillar of fibres is seen to extend vertically between the dorsal and ventral walls, thereby reducing the actual cavity of the bladder to the condition of a comparatively narrow circular canal surrounding the central pillar (*t.s.*). The antero-lateral portions of the canal are very slightly dilated, and into the dorsal wall of these regions the crescentic process of the tripus is on each side inserted in the normal fashion, but otherwise the calibre of the canal is fairly uniform throughout. Dorsally, the central pillar is closely moulded to the ventral and lateral surfaces of the centra of the complex and fifth vertebræ, and firmly adherent thereto, while the lateral portions of the bladder are applied to the ventral surfaces of the transverse processes of the fourth and fifth vertebræ. We can only regard the formation of the vertical pillar as due to an excessive thickening of the primary transverse septum, and possibly also of the anterior portion of an incomplete longitudinal septum, with the necessary result that the central or mesial portions of the bladder cavities have to a great extent become obliterated. As in the more normal types, the cavity of the air-bladder has a thin but continuous lining of tunica interna. Notwithstanding the degenerate condition of the bladder, the disposition and arrangement of the fibres forming the comparatively thin antero-lateral walls of the circular canal and their convergence in the dorsal wall to their ultimate insertion into the crescentic processes of the tripodes (fig. 98), are substantially the same as in a normal anterior chamber. Radial fibres (*r.f.*) may also be seen passing from the concavity of each crescentic process (*t.r.c.*), and, in the absence of a radial nodule, becoming attached to the free extremity of the spicular dorsal lamina (*d.l.*). We could detect no trace of a ductus pneumaticus.

The tripus has the usual three processes, but the crescentic process (fig. 98, *t.r.c.*) is very slender and has only a slight inward curvature. The scaphium is quite normal, having completely formed spatulate, condylar, and ascending processes. The intercalarium is a very feebly developed nodule in the interossicular ligament. Claustra are present with their dorsal extremities projecting into the intercalated cartilage between the spine of the third vertebra and the supraoccipital and exoccipital.

We were unable to make any satisfactory examination of that part of the internal ear which is specially related to the Weberian mechanism, but the cavum sinus imparis and its atrial diverticula, as well as the relations of the latter to the scaphia, were perfectly normal.

## IV.—MORPHOLOGICAL SUMMARY.

In summarising the more noteworthy of the results of our investigations into the morphology of the air-bladder and Weberian ossicles, and the correlated modifications which the anterior vertebræ and their processes undergo, we may indicate, in the first instance, such features as appear to be common to nearly all Siluroids, and secondly, those that are characteristic of particular genera or species.

Although only demonstrated in one particular instance (the young of *Amiurus catus*) by RAMSAY WRIGHT, our researches lead us to believe that the great majority of Siluroids agree with *Amiurus* in having the centrum of the second vertebra, and the centra, neural arches, and spinous processes of the third and fourth vertebræ indistinguishably combined to form an apparently single vertebra, for which we have ventured to suggest the name of "complex vertebra." The discovery by BAUDELLOT that the "complex vertebra" of the Cyprinidæ was formed by the fusion of the second vertebral centrum with the third vertebra, was due to the distinctness of these elements in one particular species, but no evidence of a similar nature is available in any but embryonic Siluridæ. In no adult Siluroid is there the slightest trace of intervertebral spaces or sutures between the three confluent centra; in fact, the only features which in any way suggest the composite nature of the complex vertebra in that family are the perforation of its neural arch by two pairs of spinal nerves and the occasional presence of two pairs of nutrient foramina on the ventral surface of its centrum. Nevertheless the constancy of its characters in nearly all Siluridæ and the suppression of all trace of the second vertebral centrum as a distinct element, justifies the conclusion that the complex vertebra has the same value as in *Amiurus*. This fusion of vertebræ in the formation of the "complex" is almost invariably attended by the partial ankylosis of the latter to the fifth vertebra, partly as the result of the firm sutural union of their correlated elements and in part due to the investment of the lateral surfaces of their centra by a continuous deposit of superficial bone. Moreover, the conjoined vertebræ, with the addition of the centrum of the first, are so articulated to the skull that little, if any, motion is possible, either between the individual vertebræ or between the latter and the skull. The centrum of the first vertebra is nearly always much smaller than any of the normal centra.

With the possible exception of the claustra, no distinct or ossified intercalary elements are ever present.

The first vertebra very rarely has transverse processes, and even when present (*e.g.*, some species of *Arius*) they are extremely rudimentary. Unless represented by the horizontal processes of the intercalarum in some Siluridæ (*e.g.*, *Macrones*) and the tripodes, respectively, the second and third vertebræ are always devoid of transverse processes. The transverse processes of the fourth vertebra, on the contrary, are always greatly expanded, not infrequently divided into anterior and posterior divisions



by a cleft, and with or without the aid of those belonging to the fifth vertebra form a more or less complete investment to the dorsal and anterior walls of the air-bladder. The sixth is, as a rule, the first rib-bearing vertebra; exceptionally, however, the first rib may be borne by the fifth, or even the seventh vertebra.

In almost all cases, except where they are modified to form an "elastic-spring apparatus," the transverse processes of the fourth vertebra, in addition to their characteristic relations to the air-bladder, form a more or less rigid support to the proximal elements of the pectoral girdle.

Over a somewhat triangular area, on each side, between the exoccipital in front and the anterior margin of the arch of the complex vertebra behind, the wall of the neural canal is formed only by fibrous membrane, in which the claustrum, and the ascending processes of the scaphium and intercalarium when present, are imbedded.

Of the four Weberian ossicles the claustrum has no physiological relations to the atrial cavities (atria sinus imparis of WEBER), but merely strengthens the wall of the neural canal behind the exoccipital. Each scaphium has a spatulate process which fits into and completely closes the corresponding external atrial aperture, and at the same time forms the outer wall of the atrial cavity of its side, and usually also a rounded condylar process for articulation with the centrum of the first vertebra. The intercalarium is generally represented by an elongated or discoidal nodule imbedded in the stout ligament ("interossicular ligament") connecting the scaphium with the tripus, and even if horizontal and ascending processes are present, the ossicle never articulates in the adult with the centrum of the second vertebra, to which, as a modified neural arch, it belongs. The tripus is always a tripartite ossicle with its posterior or crescentic process imbedded in the dorsal wall of the air-bladder; the anterior process is directed forwards parallel to the long axes of the complex and first centra, and opposite the external atrial aperture of its side is connected by the transversely-disposed interossicular ligament with the convex outer surface of the spatulate process of the scaphium. The articular process usually articulates with the lateral surface of the third vertebral centrum, to which, as a modified transverse process or rib, the tripus probably belongs; very rarely (*e.g.*, *Auchenipterus*) is the process directly continuous with the neural arch.

The Weberian ossicles, or at all events the free portion of the tripus and the intercalarium, are enclosed within a membranous saccus paravertebralis, the anterior wall of which is perforated by the interossicular ligament as the latter passes inwards from the tripus to its attachment to the scaphium. Unlike the Cyprinidæ, the complete closure of the external atrial aperture by the spatulate process of the scaphium and the minute size of the hypoglossal foramen in the Siluridæ completely cut off all communication between the cavity of the saccus and the cranial cavity.

With the exception, perhaps, of the Hypophthalmina and the Hypostomatina, the relations of the anterior spinal nerves to the vertebral elements with which they are associated is remarkably constant.

The first spinal or hypoglossal nerve perforates the exoccipital. The second and third spinal nerves emerge from the neural canal between the claustrum anteriorly and the arch of the complex vertebra behind, but are invariably separated by the ascending process of the intercalarium whenever that process is developed, as in *Macrones*, *Liocassis*, and *Bagroides*. The fourth and fifth spinal nerves traverse the neural arch of the complex vertebra, and the sixth the arch of the fifth vertebra. The additional spinal nerve described by SAGEMEHL in *Silurus glanis* as emerging between the claustrum and the ascending process of the scaphium, we have never met with, although our attention has been specially directed to that point.

The air-bladder varies greatly in degree of development, not only in different genera, but in different species of the same genus. Even individual variations are not infrequent, but it never exhibits that bipartite division into simple anterior and posterior sacs which is so characteristic of all other families of Ostariophyseæ. One of its most noteworthy features is a tendency to lateral development, whereby the outer walls of the anterior portion become applied, through the divergence of the dorso-lateral and ventro-lateral muscles of the body wall, directly to the external skin ("lateral cutaneous areas"). The insertion of the crescentic processes of the tripodes is always into the dorsal wall of the anterior chamber of the air-bladder in the normal Siluridæ, or into the corresponding walls of the laterally situated air-sacs in the abnormal forms, and, as a rule, takes place in such a way that the fibres forming the anterior and lateral walls of each half of an anterior chamber, or of each air-sac, converge as they pass into and form the dorsal wall, and ultimately become inserted into the convex outer margin of the tripus of that side. Specialised fibres of the dorsal wall ("radial fibres") converge like the radii of a circle from the inner concave margin of the crescentic process, and are inserted either directly into the adjacent lateral surface of the complex centrum or indirectly through the intervention of an osseous nodule ("radial nodule").

In nearly all Siluroids the lateral growth of the air-bladder, and the intimate relation of its outer walls to the lateral cutaneous areas, have led to the displacement of the lateral lobes of the liver and their enclosure within peritoneal cul-de-sacs, a condition which sometimes persists even in cases where the air-bladder has undergone partial atrophy.

In no Siluridæ are special capillary tufts or retia mirabilia (the so-called vasoganglia), invested by a special modification of the epithelium of the tunica interna, ever developed in connection with the air-bladder.

As a convenient means of summarising the more important generic and specific variations, the Siluroids may be somewhat arbitrarily divided into two principal groups:—(1) the *Siluridæ normales*, and (2) the *Siluridæ abnormales*. In the former group the air-bladder is always well developed and subdivided internally into three intercommunicating compartments, of which one is anterior, and two posterior and lateral in position. The anterior and dorsal walls of the anterior chamber may be

more or less completely invested by the modified transverse processes of the fourth and fifth vertebræ, but the latter do not form deep concave recesses or capsules for the partial or complete enclosure of the entire air-bladder.

In the Siluridæ abnormales on the contrary, the air-bladder is always very small, or even diminutive, relatively to the size of the Fish, and more or less degenerate, sometimes partially solid, but almost invariably includes two laterally situated air-sacs with simple cavities, which together may be regarded as equivalent to the anterior chamber in a normal Siluroid. Lateral compartments, as a rule, are absent altogether, or, if present, are very rudimentary. Whatever its condition, the air-bladder is almost always partially or completely enclosed within transversely disposed bony recesses, formed either by the transverse processes of the fourth vertebra alone, or in conjunction with those of the fifth vertebra.

Although a convenient method of classifying morphological facts, it is obvious that this classification, based as it is upon so variable an organ as the air-bladder, can have no genetic value.

#### 1. *Siluridæ Normales.*

Under this head may be included the genera: *Plotosus*, *Copidoglanis*, *Cnidoglanis*, *Silurus*, *Wallago*, *Cryptopterus* (certain species), *Callichrous*, *Schilbe*, *Eutropius*, *Pangasius*, *Bagrus*, *Macrones*, *Pseudobagrus*, *Liocassis*, *Bagroides*, *Rita*, *Amiurus*, *Platystoma*, *Piramutana*, *Pimelodus* (certain species), *Auchenoglanis*, *Arius*, *Hemipimelodus*, *Ketengus*, *Ælurichthys*, *Osteogeniosus*, *Batrachocephalus*, *Auchenipterus*, *Malapterurus*, *Oxydoras*, *Laïs*, and *Aspredo*.

In the Siluroids included in this group the number of rigidly interconnected vertebræ varies. The first, the complex, and the fifth vertebræ are invariably so connected together that no motion is possible between them; and occasionally the sixth, the seventh, and even the eighth, may be included in the series. The firmness of their union naturally varies with the age of the specimen, being greater in mature or old specimens than in young ones, but prolonged maceration generally has the effect of rendering all but the complex and fifth vertebræ more or less easily separable. The rigid connection of these vertebræ is effected by various means, of which the investment of the lateral surfaces of their centra by a continuous deposit of superficial bone, and the firm sutural union, or even partial ankylosis, of their neural arches and spines, are the most noteworthy. The rigidity of the complex and fifth vertebræ, with the occasional addition of the sixth, may be further increased by the sutural union or partial ankylosis of their respective transverse processes. The anterior vertebræ are also firmly connected to the skull, generally by the articulation of the arch and spine of the third vertebra with the exoccipitals and supraoccipital, the transverse processes of the fourth vertebra with the post-temporals, and the spinous processes of the third and fourth vertebræ with the supraoccipital spine; less frequently by the formation of interlocking accessory articular processes on the

contiguous ventral margins of the basioccipital and the centra of the first and complex vertebræ. In some Siluroids the same result is secured by the downward growth and coalescence of the accessory processes, to form a stout subvertebral process. In other Siluroids the connection of the skull with the anterior vertebræ may be rendered still more intimate by the articulation of the spine of the supraoccipital with the expanded dermal plates of the first and second interspinous bones (*e.g.*, *Auchenipterus*, *Oxydoras*, &c.), or even by the extension of bony laminæ between the supraoccipital and the dorsal surfaces of the transverse processes of the fourth vertebra (*e.g.*, *Arius*, *Batrachcephalus*, *Osteogeniosus*, and *Ketengus*).

The centrum of the first vertebra varies greatly in size, but is always smaller than any of the other anterior vertebral centra. Two pit-like sockets are always found on its dorsal surface for the reception of the condylar processes of the scaphia. The complex and fifth centra are the largest, or at all events the longest, of the anterior centra, and, as a rule, their anterior and posterior concavities are unsymmetrically developed. In nearly all cases these centra are not only elongated, but laterally compressed, so as to form a prominent subvertebral keel, which gives rise to a deep groove along the medio-dorsal line of the anterior chamber of the air-bladder, and, at the same time, internally, to a well marked longitudinal ridge partially subdividing the cavity of the chamber into two laterally bulging halves. As a rule the centrum of the complex vertebra is much longer than the centrum of the fifth vertebra, although, exceptionally, it may be shorter than the latter (*e.g.*, *Platystoma*). Its concavities may be subequal (*Arius*), but more frequently the posterior is much the deeper of the two, and may even be almost tubular. One (*Macrones*) or two (*Synodontis*) pairs of nutrient foramina are present on its ventral surface, and apparently belong to the third and fourth vertebræ. A pair of accessory articular processes may be developed on the anterior margin of the ventral surface of the complex centrum, and may interlock with similar paired processes developed from the adjacent margins of the basioccipital and the centrum of the first vertebra (*e.g.*, *Macrones*). The centrum of the fifth vertebra is generally shorter than the complex centrum, but in one or two instances (*e.g.*, *Platystoma*) it may equal or exceed the latter in length. Its two concavities are rarely subequal; more frequently the anterior is much the deeper, and sometimes may be even tubular (*e.g.*, *Aspredo*, *Platystoma*). The sixth vertebral centrum is also nearly always larger than any that succeed it, although smaller than either the complex or fifth centrum. Its concavities are equal or subequal, but occasionally, as in the fifth, the anterior may be much deeper than the posterior.

The neural arch of the complex vertebra is always represented by two lateral and continuous plates of bone, confluent above with the spines of the third and fourth vertebræ and below with the centrum. The lateral vacuities, which in some Siluridæ (*e.g.*, *Platystoma* and *Auchenoglanis*) partially interrupt the continuity of the arch, may possibly indicate a separation between the otherwise confluent arches of the third and fourth vertebræ. As a rule, the arch is partially or completely anchylosed

to that of the fifth vertebra, which in turn may be similarly connected with the arch of the sixth vertebra, or the rigid union of the different neural arches may be effected by a firm sutural union only. Even when not actually anchylosed it is rare for the arches of the fifth, sixth, or seventh vertebræ to be movably articulated by means of pre- or post-zygapophyses as is the case with the normal free vertebræ that follow.

The spinous processes of the third and fourth vertebræ are either confluent to form a thin vertical lamina of bone (*Macrones*), or fused only at their roots, their distal extremities being free and divergent (*Arius*). The spine of the third vertebra is almost always grooved anteriorly and inclined forwards over the body of the first vertebra to an articulation with the exoccipitals and supraoccipital; in the groove a modicum of intercalated cartilage is very generally present, more especially in young or immature specimens. The spine of the fourth vertebra is usually directed backwards and, like the succeeding spines, is generally cleft for the support of certain of the interspinous bones of the dorsal fin, but in the absence of the latter may, like its fellows, be simple and undivided (*e.g.*, *Malapterurus*). The spines which immediately succeed the foregoing may be rudimentary or obsolete (*Arius*), or well-developed and bifid; not infrequently they are either partially anchylosed or firmly articulated to one another and to their predecessors.

The transverse processes of the fourth vertebra, very frequently those of the fifth, and more rarely those belonging to the sixth vertebra (*Platystoma*), are more or less expanded and by their partial anchylosis or sutural union form on each side of the vertebral column a broad wing-like plate of bone, the anterior margin of which is strongly decurved, for the investment of the anterior and dorsal walls of the anterior chamber of the air-bladder. The transverse process of the fourth vertebra has a broad flat root, and for the rest of its extent may be simple, or, as is more usually the case, cleft more or less deeply into distinct anterior and posterior divisions, of which the former is always strongly decurved towards its distal extremity and closely applied, even if not attached, to the lateral portion of the anterior wall of the air-bladder. The anterior division is usually applied distally to the inferior limb and stem of the post-temporal, and firmly united thereto by a ligament in such a way as to afford a rigid support to the proximal portion of the pectoral girdle. The entire transverse process invariably has its origin, not from the centrum, but from the whole length of the continuous neural arch of the complex vertebra. In certain Siluroids this process becomes modified to form the singular "elastic-spring" apparatus first described by JOHANNES MÜLLER. In some of these forms (*Malapterurus*, *Synodontis*, *Pangasius*) each anterior division is almost completely separated from the posterior division, with an oblique origin from the arch of the complex vertebra, and becoming flexible and highly elastic, expands distally into an ovoid plate which is closely applied to the corresponding lateral portion of the anterior wall of the air-bladder. In others (*e.g.*, *Oxydoras* and *Auchenipterus*) the anterior division undergoes a similar modification, but the posterior division has become completely suppressed. In all such

cases the modified transverse processes are provided with powerful protractor muscles, in the form of specialized portions of the dorso-lateral musculature, which have their origin on the posterior face of the skull and their insertion into the anterior surfaces of the terminal oval plates. The transverse processes of the fifth vertebra are, as a rule, but moderately expanded, although in one case (*e.g.*, *Platystoma*) they may be as greatly expanded as the preceding processes with which, in this genus, they are in sutural union anteriorly. They are often confluent at their roots with the transverse processes of the fourth vertebra, but their distal extremities are always free. Rarely are they rudimentary (*Auchenipterus*) or absent (*Oxydoras*). Like their predecessors they have their origin from the neural arch instead of from the centrum, but always at a slightly lower level than the former. The transverse processes of the sixth vertebra vary greatly in size and in degree of expansion. They may be greatly expanded and suturally united to those of the fifth vertebra (*Platystoma*), or, while of slightly greater length, may not be more expanded than the normal processes which follow them. Their origin is always from the centrum of their vertebra. Usually they carry the first pair of ribs, but in at least two genera (*Callichrous* and *Cryptopterus*) the latter are supported by the transverse processes of the fifth vertebra.

A continuous deposit of superficial bone invests the lateral surfaces of more or fewer of the anterior vertebral centra. It varies greatly in thickness as well as in extent in different Siluroids, and sometimes forms no inconsiderable portion of the otherwise somewhat attenuated anterior centra. The centra of the complex and fifth vertebra are invariably so invested; less frequently the deposit may extend on to the lateral surfaces, or at all events along the ventro-lateral margins of the sixth and seventh, or even the eighth vertebræ. The ossifications are always strongly developed along the ventro-lateral edges of the centra they invest in the form of parallel ridges, which enclose between them a deep median groove for the dorsal aorta (*e.g.*, *Macrones*). By the ventral union of these ridges the groove may become converted into a complete canal (*Arius*, *Auchenipterus*, *Platystoma*, &c.). Exceptionally, the dorsal aorta appears to burrow its way through a canal in the centra of the complex, the fifth, and the sixth vertebræ (*Platystoma*), a fact which in this case is apparently due to the unusual thickness of the investing superficial ossifications. The ossifications may also extend laterally on to the ventral surfaces of more or fewer of the anterior transverse processes, forming a floor for the cardinal grooves, and thereby converting the latter into complete canals (*e.g.*, *Arius*, *Batrachocephalus*, *Osteogeniosus*, &c.). They usually obscure the intervertebral sutures between the different vertebral centra, but sometimes (*e.g.*, *Platystoma*) the sutures are obvious externally on the surface of the investing ossifications in the form of wavy interdigitating lines.

Special developments of the system of superficial ossifications also take place in relation with the skeletal attachments of the air-bladder in the region of the complex vertebra. The anterior margins of the ossifications investing the sides of the complex centrum are thickened near the anterior extremity of the latter in the form of two

more or less well-marked oblique lateral ridges, which coincide with the mesial attachment of the dorsal edge of the transverse membrane, and not infrequently, also, with the corresponding attachment of the anterior pillars of the air-bladder. An osseous nodule (radial nodule) is invariably attached to the dorsal and hinder extremity of each lateral ridge, sometimes by ankylosis, especially in old specimens, but more frequently by a firm fibrous union. These nodules coincide with the fixed attachment of the radial fibres of the tripodes. A slender lamina or spicule of bone is prolonged from the dorsal extremity of each lateral ridge, from which, however, it is often distinct, and passing obliquely backwards and outwards ventrad to the cardinal groove, extends for a varying distance on to the ventral surface of the transverse process of the fourth vertebra, and finally blends therewith. This lamina (dorsal lamina) corresponds with the dorsal attachment of the transverse membrane, and posteriorly often receives the insertion of a sheet of fibres derived from the lateral portions of the primary transverse septum of the air-bladder.

The lateral surfaces of the complex and fifth centra are almost always traversed by deep grooves which are situated between the dorsal margins of the superficial ossifications and the roots of the modified transverse processes. As a rule each groove is completely encircled by bone only in the region of the dorsal lamina, but in those cases (*e.g.*, *Arius*, *Osteogeniosus*) where the superficial ossifications extend from the sides of the complex and fifth centra on to the ventral surfaces of the transverse processes of the fourth vertebra, the groove becomes a complete canal for its whole length. The grooves transmit the posterior cardinal veins, and very generally also the attenuated anterior portions of the mesonephros as they pass forwards to join the so-called "head kidney" anteriorly. In correspondence with the unsymmetrical development of these veins, the right cardinal groove or canal is always much larger than the left.

Stout subvertebral processes are frequently developed in relation with the anterior end of the complex centrum. In some forms (*Arius* and its allies) the process is a strong conical structure apparently formed by the downward growth and coalescence of processes derived from the ventral surfaces of the basioccipital and the first and complex vertebræ, but thickened posteriorly by the superficial ossifications of the complex centrum. In others (*e.g.*, *Plotosus*) paired processes, formed apparently by an extension of bony deposit from the superficial ossifications of the complex centrum into the mesial portion of the transverse membrane, may together form a transversely-disposed, fan-shaped subvertebral process. In *Plotosus* the latter only are present, but in *Auchenoglanis* an additional pair of similar but smaller processes are developed from the ventral surface of the body of the first vertebra, and serve to buttress anteriorly the former pair. All such subvertebral processes, while partially owing their formation to an exaggerated development of the accessory articular processes which are normally present in some Siluroids (*e.g.*, *Macrones*), are, nevertheless, greatly thickened and enlarged by their association with the contiguous superficial

ossifications. In all forms in which these processes are present they form a rigid support to the mesial portion of the anterior wall of the air bladder, and are usually cleft (*Auchenoglanis*) or perforated at the base (*Arius*) for the transmission of the dorsal aorta.

In the pectoral girdle the post-temporal bone always has a transversely or obliquely disposed inferior limb for articulation at its inner extremity with the lateral surface of the basioccipital, in addition to an ascending process for articulation with the pterotic and epiotic bones, and a descending process or stem for articulation with the clavicle. The socket for the clavicle is usually formed by a deep cleft in the stem, which is often more or less completely closed by the opposition of the transverse process of the fourth vertebra. Where the transverse process of the fourth vertebra fails to articulate with and support the post-temporal, as is the case in all Siluroids possessing an "elastic-spring" apparatus, the inferior limb of the latter is exceptionally massive, with an extensive articulation, or even partial ankylosis, with the basioccipital, or, in addition, with the exoccipital also. In other genera (*Macrones*, *Bagrus*, &c.) the inferior limb, in conjunction with the body of the same bone, may form a bony expansion or post-temporal plate, which, with the produced crescentic distal extremity of the anterior division of the transverse process of the fourth vertebra, forms a slightly concave bony structure for the support of the lateral portion of the anterior wall of the bladder. From being but faintly concave on its posterior face, the post-temporal plate and the adjacent portion of the inferior limb may become deeply excavated to form a goblet-shaped cavity, into which a thin-walled cæcal diverticulum of the air-bladder extends (*Macrones aor.*).

Where post-temporal plates are formed the sockets for the clavicles are in the form of tubular canals traversing the substance of the plates.

Apart from those which are characteristic of all Siluroids, no important modifications of the hinder part of the skull are observable in the normal members of the group, either as regards the more general features of structure, or the more special points involved in the mode of formation and relations of the "cavum sinus imparis," or of its bilobed backward prolongation, the "atria sinus imparis." The uniformity in the latter respect is so marked, that a description of those structures as they occur in any one normal Siluroid (*e.g.*, *Macrones*) will practically apply to all the others.

Of the minor variations we may remark the occasional translucency of certain of the periotic bones, such as the prootic and epiotic bones, and the opisthotic plates of the exoccipitals; the strengthening of the posterior wall of the atrial cavities by a column-like process of bone derived from the dorsal margin of the posterior face of the basioccipital, or by a slight downward growth of the posterior margin of the roof of the cavum sinus imparis, and the withdrawal of the external atrial apertures altogether within the neural canal (*e.g.*, *Aspredo*).

As regards the internal ear, the condition of many of our specimens was such



that our observations were necessarily somewhat incomplete. The condition of the membranous labyrinth, and its relations to the cavum sinus imparis and to the atrial cavities, were investigated in a large number of Siluridæ normales, but with the purely negative result that we could detect no variations of any importance from the arrangement of these structures, already described for *Amiurus catus* by RAMSAY WRIGHT, and for *Silurus glanis* by WEBER, and in *Macrones* by ourselves. In all cases we found a transversely disposed ductus endolymphaticus connecting the two sacculi, and, attached to the ductus, a median pear-shaped sinus endolymphaticus projecting backwards into, and almost completely filling, the "cavum sinus imparis."

With the exception of the intercalarium, the Weberian ossicles exhibit but little variety in shape, or in their relations to one another, or to the atrial cavities and air-bladder. The variations in the condition of the tripus relate principally to the degree and shape of the curvature of its posterior or crescentic process. In some genera (*Auchenipterus*, *Oxydoras*) the "crescentic process" is almost straight; in others almost hook-shaped (*Plotosus*); and between these extremes the process may exhibit almost every degree of curvature. A ventral ridge on the root of the crescentic process, to receive the insertion of a slip of fibres from the adjacent anterior wall of the bladder, is very generally present, and varies in size according to the thickness of the walls of the bladder. In some Siluroids (*Macrones*, *Liocassis*) the outer convex margin of the process may be increased for the purpose of fibrous attachment, and possibly for leverage, by the addition of an outwardly directed heel-like process, which occasionally may be of considerable length (e.g., *Bagroides*). The articular process of the tripus is usually distinct from the complex centrum, with which, however, it articulates at the bottom of a deep pit-like depression. It is very rare, as in the two genera *Oxydoras* and *Auchenipterus*, for the process to be flexible and elastic, and directly continuous by an oblique origin with the anterior part of the neural arch of the complex vertebra, like the adjacent and similarly elastic root of the "elastic-spring" apparatus. The proportional lengths of the anterior and crescentic processes vary somewhat in different forms; generally, the two processes are of approximately equal length, but when otherwise it is the anterior which is the longer.

The intercalarium varies greatly in development. Usually a small osseous nodule imbedded in the interossicular ligament, the intercalarium may, in addition, be prolonged therefrom as a horizontal spicule which terminates in the fibrous wall of the neural canal, between the arch of the complex vertebra and the ascending process of the scaphium, near the dorso-lateral margin of the anterior portion of the complex centrum, with which, however, it is in no way directly attached (*Cryptopterus*, *Callichrous*). In a few genera (*Macrones*, *Liocassis*, *Pseudobagrus*, &c.) the horizontal process is prolonged upwards into a vertically disposed or ascending process, which also lies in the fibrous wall of the neural canal, behind and parallel to the ascending process of the scaphium. In all cases where an ascending process is

present, it lies between the paired foramina for the exit of the dorsal and ventral roots of the second and third spinal nerves.

The only variations noticed in the condition of the scaphium relate to the occasional absence of an ascending process ; a globose condylar process is always present.

Claustra are invariably present, but vary greatly in size, from the usual condition of extremely slender spicules to somewhat triangular plates (*Pangasius Buchanani*).

The air-bladder has the same fundamental structure in all the *S. normales*. In all cases the organ is more or less cordate in shape, and is subdivided internally by a T-shaped arrangement of a primary transverse septum and a longitudinal septum into three intercommunicating compartments, of which one is anterior and transversely disposed, occupying the anterior third of the bladder, and two posterior and lateral longitudinally arranged chambers, constituting the posterior two-thirds of the bladder. The dorsal wall of the anterior chamber is closely moulded to the ventral and lateral surfaces of the complex and fifth vertebral centra, including the sub-vertebral keel which these centra form, and also to the ventral surfaces of the modified transverse processes of the fourth and fifth vertebræ. The lateral portions of the anterior wall of the chamber are also partially buttressed by the decurved anterior margins of the transverse processes of the fourth vertebra, with or without the aid of the expanded inferior processes of the post-temporals (post-temporal plates), while the median portion of the wall is not infrequently supported by a sub-vertebral process (*e.g.*, *Arius*). The lateral compartments, on the other hand, are neither invested by bone, nor are they in any way directly attached to the skeleton, but lie free in the abdominal cavity. Except in relation to the size of the Fish, the variations in the capacity of the anterior chamber as compared with those of the lateral compartments are but slight, and, as a rule, any increase or diminution in the relative size of the bladder is mainly due to variations in the size of the lateral chambers. With the exception of two genera (*Rita* and *Aspredo*) included in this group, the capacity of the anterior chamber is always much smaller than the combined capacities of the two lateral chambers, and, in one of the two exceptions referred to (*Rita*), the partial suppression of the lateral compartments is compensated by the development of two large lateral cæca from the anterior chamber. In the two genera last mentioned the lateral chambers are very small in one (*Rita*), and almost non-existent in the other (*Aspredo*), but in both cases a primary transverse septum is present, and retains its normal attachments to the skeleton. Apart from its longitudinal constriction into two laterally bulging halves—a separation which in some cases (*e.g.*, *Arius*, *Callichrous*, &c.) may be emphasised by the formation of one or two longitudinally arranged and inwardly projecting ridge-like aggregations of fibres from the median line of the posterior, ventral, and anterior walls—the cavity of the anterior chamber has smooth walls, and is not subdivided by the growth of internal septa.

The lateral compartments may also have undivided cavities (*e.g.*, *Auchenoglanis*, *Callichrous*, and *Silurus*), but not infrequently they are rendered more inexpandible,

and possibly at the same time less compressible, by the formation of a variable number of secondary transverse septa (*e.g.*, *Macrones*), which incompletely subdivide each chamber into a series of transversely arranged, intercommunicating spaces. The support which these septa afford to the walls of the lateral chamber is, in some cases, strengthened by root-like bundles of fibres which grow out from the dorsal and ventral margins of the septa, and extend into the corresponding walls of these chambers. Occasionally the excessive development of these septa, and their union by root-like bundles of fibres which pass between their opposed surfaces, may lead to the formation of a thick trabecular network of fibrous columns or bands, and to the partial obliteration of the cavities of the two chambers (*Pangasius*).

The width of the primary transverse septum, forming the posterior wall of the anterior chamber, varies greatly in different Siluroids. In some (*e.g.*, *Auchenoglanis*) the septum is co-extensive with the width of the air-bladder, although contracted dorsally to admit of the lateral chambers communicating with the anterior chamber; in others (*e.g.*, *Callichrous*, *Cryptopterus*) the septum is reduced to the condition of a narrow, but stout, column-like aggregation of fibres.

In many members of this group the primary transverse septum, and more particularly its median portion, is more or less oblique, and in some extremely so. This obliquity of the septum has the effect of causing the lateral chambers and the longitudinal septum to extend forwards to a varying extent, ventrad to the inclined septum, and consequently to overlap the anterior chamber along the greater part of its ventral surface.

Cæcal appendages to the anterior and lateral compartments are not uncommon. The anterior chamber may have small anterior cæca (*Macrones aor*), or much smaller antero-lateral cæca (*Osteogeniosus*). In the former case the cæca bulge forwards into goblet-shaped cavities excavated in the substance of the inferior processes of the post-temporal bones. Lateral cæca are sometimes present, and may either take the form of large funnel-shaped structures, which extend the whole length of the abdominal cavity and are entirely free from internal subdivisions (*Rita*), or may occur as small forwardly directed outgrowths, subdivided internally by a network of fibrous bundles, and communicating with the anterior chamber by a number of slit-like orifices in its lateral walls (*Platystoma*). The lateral compartments are frequently either constricted or prolonged into a posterior cæcal appendage. This may be a longer or shorter tubular, or a slightly oval structure, and confined to the abdominal cavity (*Pangasius Buchanani*, *Bagroides melanopterus*), or a long tapering tubular structure, which, after traversing the abdomen, extends for some distance along the right side of the tail between the hæmal arches and the lateral musculature (*e.g.*, *Cryptopterus micronema* and *C. micropogon*). In some cases the posterior cæcum is very large, and in shape an elongated oval body (*Pangasius djambal*, *Malapterurus electricus*), or it may be flattened and leaf-like (*Pangasius macronema*). In one instance (*Oxydoras*) it is very rudimentary. The existence of a pair of rudimentary

posterior cæca is very rare (*Auchenipterus obscurus*). Very generally the longitudinal septum extends backwards into the posterior cæcum, and subdivides its cavity into two distinct lateral canals or chambers, which communicate anteriorly with the proper lateral compartments of the bladder. Not infrequently the single or double cavity of the cæcum is partially subdivided internally by a series of circularly disposed, inwardly projecting ridges (e.g., *Malapterurus*). In some Siluroids (*Pangasius*), where the lateral chambers are largely occupied by a trabecular network of fibrous bundles, the cavity of the posterior cæcum is largely obliterated by the formation of a similar growth. It may be remarked that cæcal appendages are very characteristic of those Siluroids in which an "elastic-spring" apparatus is present. They may be very rudimentary (e.g., *Auchenipterus obscurus* and *Oxydoras*), but it rarely happens (e.g., *Auchenipterus nodosus*) that they are completely absent. Even when present and well developed in such Siluroids, there is considerable variety in the extent to which the cavities of these appendages are sub-divided, or even partially obliterated by the growth of internal septa and fibrous trabeculæ.

Except, perhaps, in the case of *Rita*, the significance of these cæcal structures is not always obvious. This is more particularly the case with the posterior cæcal prolongations of the air-bladder, but with the antero-lateral cæca it is somewhat different, and a possible explanation of their existence may be suggested.

A branching condition of the air-bladder, with the branches ending in cæcal extremities, is very common in certain Physoclist genera,\* and occasionally such branches may acquire a close relation with the internal ear. In the genera *Holocentrum* and *Sargus*, two cæcal processes are given off from the anterior end of the air-bladder, which diverge as they pass forwards, and ultimately become applied to the fibrous membranes, closing what would otherwise be vacuities in the outer walls of the auditory capsules. A similar arrangement has been described by PARKER (31) as existing in the Red Cod (*Lotella bacchus*), while WEBER (39) first recorded the existence of an analogous but more intimate connection between the two structures in the Herring (*Clupea harengus*). It may at least be conjectured that the connection between the air-bladder and the internal ear in these Fishes subserves a function similar to that of the Weberian mechanism in the Ostariophyseæ, although, no doubt, in a very primitive and rudimentary fashion, and, therefore, that these cæcal structures represent an initial stage in the evolution of that mechanism. We are not aware of the existence of antero-lateral cæca in any Ostariophyseæ but the Siluridæ. SAGEMEHL (33), however, has described the tunica externa of the air-bladder in certain Characinidæ, as being prolonged forwards in the form of a twisted ligament, which anteriorly splits into two, and is attached to the posterior portion of the base of the cranium. Although these ligaments are solid, and have no lumen, and it is expressly stated that the tunica externa has no share in their formation, SAGEMEHL regards them as the atavistic vestiges of

\* See GÜNTHER (14, pp. 144-145; also 15).

an original and primitive connection between the air-bladder and the internal ear, which preceded the evolution of the Weberian mechanism, but is apparently still retained in some cases. The suggestion is certainly an ingenious one, but as regards the Characinidæ, we are not sure that much can be said in its favour. It is quite possible that the ligaments in question are merely illustrations of the many and various ways in which the air-bladder in the Ostariophyseæ becomes more or less intimately attached to the skeleton for physiological purposes, and, after all, may have no such significance as that suggested. On the other hand, the antero-lateral cæca of such Siluroids as *Macrones aor*, *Osteogeniosus*, and *Platystoma*, are hollow forward prolongations of the air-bladder, involving extensions of both the tunica externa and interna, and in their case SAGEMFHL's suggestion may be reasonably accepted.

The persistent and usually bilobed "head-kidney" usually occupies a recess of corresponding shape in relation with the anterior wall of the air-bladder, to which indeed its posterior surface is closely applied. The peritoneum invests the ventral surface of the air-bladder, and, anteriorly, extends over the corresponding surface of the "head-kidney," but at the anterior margin of the latter is reflected backwards along the dorsal surface of the œsophagus. Outwardly directed peritoneal cul-de-sacs in relation with the antero-lateral regions of the air-bladder are almost invariably developed for the reception of portions of the lateral lobes of the liver. Their formation appears to be due to the unusual lateral extension of the anterior chamber of the air-bladder, and its apposition on each side to the external skin (lateral cutaneous areas)—a modification which has led to the displacement of the lateral lobes of the liver from their normal position between the bladder and the side walls of the body, and to the outward and forward hernia-like protrusion of a portion of each lobe into special peritoneal pouches. Between the peritoneum and the proper ventral wall of the air-bladder the latter is invested by a superficial coat of connective tissue which varies in consistency and often assumes the condition of a definite fibrous membrane, more particularly where it invests the anterior wall of the bladder, in which position it forms a fairly strong, inextensible, transversely disposed, fibrous membrane, varying in thickness in different Siluroids, and specially attached to the skeleton along its dorsal edge and lateral margins. To a varying extent this superficial coat may be traced on to the lateral and dorsal walls, as well as the anterior wall of the anterior chamber, and also, but less obviously, on to the corresponding surfaces of the lateral compartments. The skeletal attachments of the transverse membrane vary somewhat in different Siluroids. Dorsally, it is always attached near the median line to the complex centrum and especially to its oblique lateral ridges, and by a special backward prolongation to the anterior margin of each dorsal lamina, and also to the anterior margins of the transverse processes of the fourth vertebra; laterally, it is firmly attached to the decurved distal extremities of the transverse processes and there blends with the ligamentous fibres by which the

latter are usually connected with the post-temporals. The dorsal margin of the membrane is always more or less continuous with the fibrous floor of the saccus paravertebralis. Where an "elastic-spring" apparatus is present the membrane is continuous with the margins of the terminal plates, and from thence is continuous with the connective tissue investment of the lateral and ventral surfaces of the anterior chamber of the air-bladder. In those Siluroids in which subvertebral processes are present the transverse membrane is always attached to their lateral and ventral margins.\* Anteriorly, the dorsal margin of the transverse membrane is more or less obviously continuous with an aponeurotic membrane which, after investing the dorsal surface of the "head-kidney," and the ventral surfaces of the centrum of the first vertebra and the hinder portion of the basioccipital, extends ventrally as a transversely disposed fibrous sheet in relation with the anterior surface of the "head kidney," and laterally blends with the ligamentous fibres that unite the post-temporals with the transverse processes of the fourth vertebra. This aponeurotic membrane we regard as a dorsal and backward extension of the same fibrous sheet that, ventrally, separates the pericardial and abdominal cavities. On the contrary, the connective tissue investment of the air-bladder and its special development, the transverse membrane, must be considered as belonging to that organ, of which it is really the superficial coat. These structures are of some interest for two reasons—first, because they are liable to become the seat of ossified deposit; and, secondly, because the inextensibility and the skeletal attachments of the transverse membrane enable it to supplement other structures in affording a rigid support to the anterior wall of the bladder.

In almost all normal Siluroids the lateral or outer walls of the anterior chamber of the air-bladder are more or less extensively and intimately applied to lateral cutaneous areas, and this relation of the two structures is always brought about by the divergence of the dorso-lateral and ventro-lateral muscles of the trunk combined with an unusual lateral extension of the anterior portion of the bladder.

In all the normal Siluroids, without an exception, a ductus pneumaticus is present, and, after a sigmoid or slightly tortuous course, opens into the anterior chamber in the median line of its ventral wall, and immediately in front of the ventral margin of the primary transverse septum.

The general structure of the walls of the air-bladder in all normal Siluroids is essentially similar to that we have already described in *Macrones* (p. 92), but their thickness is subject to considerable variation in different species. The fundamental arrangement of the fibres of the tunica externa in the form of an inner stratum of circularly disposed fibres and an outer stratum of longitudinal fibres is always so far

\* In a few genera, and notably in the normal *Pimelodinæ*, no distinct transverse membrane exists, and in such cases it seems probable that the membrane has coalesced with the proper anterior wall of the bladder, and shares with the latter its dorsal attachment to the anterior margins of the transverse processes.

departed from, that the fibres of both strata vary their course and direction in different parts of the bladder, although at any one point the fibres of one layer rarely agree in direction with those of the other, but intersect at a greater or less angle. It is only as the two strata approach their common attachments to the skeleton that their component fibres coincide in direction. The variable course of the fibres is largely due to the differentiation of special tracts of fibres in certain regions of the air-bladder for skeletal attachments.

Not only is the anterior compartment of the air-bladder more or less completely invested by bone on its dorsal and anterior surfaces, but its walls are attached to rigid portions of the axial skeleton and to movable ossicles at certain special points. As to the nature and extent of the fixed skeletal attachments, there is substantial uniformity in the different members of the group, and the physiological effect of such skeletal connections is, in the great majority of cases, the same, viz., to render the anterior, dorsal, ventral, and posterior walls incapable of participating in any distension of the chamber, which, consequently, must solely depend upon the movement of the lateral walls. The posterior wall, *i.e.*, the primary transverse septum, is always attached at its dorsal margin to the ventral and lateral surfaces of either the complex or the fifth centrum—rarely to the sixth centrum; laterally to this the dorsal edge of the septum is invariably attached to the ventral surfaces of the transverse processes of the fifth vertebra, or to those of the fourth vertebra, or exceptionally to the corresponding processes of the sixth vertebra; and, in addition, a sheet of fibres is often prolonged forwards, on either side of the complex centrum, into the dorsal wall, where it eventually becomes attached to the dorsal lamina of its side. These attachments we have elsewhere referred to as the “posterior pillars” of the compartment. As the anterior wall is usually more or less efficiently buttressed by the transverse processes of the fourth vertebra, or by post-temporal plates, or median subvertebral processes, the extent of its attachment to the skeleton varies inversely with the extent to which it is invested or supported by bone. The median portion of the wall is always attached dorsally to the ventral surface and sides of the anterior portion of the complex centrum, often by means of laterally situated, oblique, bony ridges, and also to the radial nodules. Laterally to this, on each side, the anterior wall may be so completely invested by bone as to be free from any special connexion or attachment to rigid portions of the axial skeleton (*e.g.*, *Macrones*); or in correlation with a less complete bony support, the outer stratum of the tunica externa of the anterior wall may separate dorsally from the inner stratum, and become firmly inserted into the decurved anterior margin of the transverse process of the fourth vertebra (*e.g.*, *Arius*, *Auchenoglanis*, *Pimelodus*). The dorsal attachment of the median portion of the anterior wall to the radial nodules and to the complex centrum occurs in all the normal Siluroids, and may be regarded as constituting the “anterior pillars” of the compartment. The ventral wall may also be considered as rigidly attached to the skeleton, both in front and behind, inasmuch as its inner stratum

of longitudinally disposed fibres, sometimes thickened into stout inwardly projecting ridges, extends into both the anterior and posterior walls, and shares the skeletal attachments of the anterior and posterior pillars.\* Although, as a rule, extremely thin, the median portion of the dorsal wall, over an area bounded in front and behind by the anterior and posterior pillars, and laterally by the dorsal walls of the two outwardly bulging halves of the chamber, is always firmly attached to the ventral and lateral surfaces of the complex centrum, and possibly also to those of the fifth centrum.

The attachment of the walls of the anterior chamber to movable ossicles (the tripodes) is effected by the convergence of the fibres of both strata of the tunica externa of the anterior and lateral walls into the dorsal wall in the form of two triangular sheets, and their ultimate insertion into the crescentic processes of the tripodes, which are situated near the anterior and inner corners of the lateral halves of the anterior chamber. As pointed out in the special case of *Macrones nemurus*, it is generally also the case in most other normal Siluroids that the fibres, which at one end of their course are inserted into the movable tripodes, are at the other extremity absolutely or relatively fixed, the fibres of the inner stratum of the tunica externa being successively continued from the ossicles into the dorsal, the lateral or antero-lateral walls, and eventually into the ventral wall, and from thence into the primary transverse septum to the skeletal attachments of the latter, while the curvilinear fibres of the outer stratum follow the same course until they reach the lateral walls, from whence they are ultimately traceable into the relatively fixed or inexpandible walls of the lateral compartments. The variations in the extent to which these fibres are attached to the tripodes are mainly confined to one feature. A slip of fibres derived from the median portion of the anterior wall is always inserted dorsally into the ventral ridge of each tripus, or directly into the ventral surface of the ossicle when the ridge fails to be developed. Laterally to this point the fibres forming the whole thickness of the tunica externa of the anterior and lateral walls may converge in the dorsal wall and become attached to the tripodes (*e.g.*, *Macrones*); or as in many other Siluroids (*e.g.*, *Arius*, *Pimelodus*, &c.), the outer stratum of the anterior wall is continuously attached by its dorsal edge to the transverse process of the fourth vertebra, and only the comparatively thin inner stratum, in addition to the fibres of both strata from the lateral walls, extend into the dorsal walls and constitute the triangular sheets. In the latter case but few, if any, of the fibres of the inner stratum reach the tripodes, which, in consequence, only receive the direct insertion of the outer stratum of the tunica externa of the lateral and antero-lateral walls.

\* A further device, with the like object of giving additional rigidity to the ventral wall, may, perhaps, be found in the obliquity of the primary transverse septum, and in the tendency of the lateral compartments to more or less completely overlap the anterior chamber on its ventral side, which are such obvious features in the air-bladders of many species of *Arius* and some *Pimelodinae*.



Radial fibres arising from the radial nodules and inserted into the concave inner margins of the crescentic processes of the tripodes or into the corresponding margins of their ventral ridges are invariably differentiated from the dorsal wall of the anterior chamber. In two instances (*Auchenipterus*, *Oxydoras*), where the function of the radial fibres is taken by the flexible and highly elastic articular process of the tripus, the former are but scantily and feebly developed.

As we have previously pointed out, the lateral compartments of the air-bladder are neither invested by bone nor are they directly attached to the skeleton, but project freely into the anterior portion of the abdominal cavity. The most important feature in connection with their structure, apart from their relatively greater capacity when compared with the anterior chamber, is their separation by a common longitudinal septum and the frequently septate condition of their cavities. Physiologically, the longitudinal septum and the secondary transverse septa subserve the double function of rendering the lateral chambers almost incapable of distension, and at the same time diminishing the susceptibility to the effects of external pressure. Hence it follows that all variations that may take place in the volume of the air-bladder are dependent on the lateral expansion or contraction of the anterior chamber.

Not the least remarkable feature in the air-bladder of the Siluroid Fishes is the liability of its walls to become invaded by ossified deposit, either by extension from certain of the adjacent skeletal elements which are always more or less intimately connected with the organ, or by apparently independent ossifications that subsequently coalesce with the contiguous skeletal structures. The oblique lateral ridges of the complex centrum are clearly ossifications of the transverse membrane along the line of its mesial and dorsal insertion into the lateral surfaces of the centrum. Similarly, the dorsal laminae are to be regarded as ossifications of the dorsal portion of the superficial coat of the air-bladder. In our previous references to the skeletal attachments of the dorsal margin of the transverse membrane we described the latter as not only inserted into the lateral ridges of the complex centrum, but also as being prolonged backwards on each side of the centrum and dorsad to the anterior chamber of the bladder in the form of a slip of fibres which is ultimately inserted into the anterior margin of the dorsal lamina of its side. The direction of the dorsal lamina, as it passes from the ventral surface of the transverse process of the fourth vertebra to its junction with the lateral ridge of the complex centrum and the radial nodule, exactly coincides with the course of this strip of fibres, so that the lamina appears as an ossified backward prolongation of the latter to an original insertion into the modified transverse process. In fact, there can scarcely be any doubt that both the lateral ridges and the dorsal laminae result from the ossification of the superficial coat of the bladder along the lines of its primitively wholly fibrous attachments to the sides of the complex centrum and to the ventral surfaces of the transverse processes of the fourth vertebra. The slightly free posterior margin of the dorsal lamina, as we have already mentioned, receives the insertion of the more laterally situated fibres of the

posterior pillars which curve forwards into the dorsal wall of the anterior chamber, and it is possible that the ossification of those fibres along the line of their skeletal attachment may have somewhat widened the lamina in some Siluroids (*e.g.*, *Macrones*), but in many others (*e.g.*, *Platystoma*, *Malapterurus*, &c.), where the dorsal lamina is represented in the usual position by a very slender spicule of bone, and the lateral portions of the posterior pillars are inserted more posteriorly than in *Macrones*, that is, to the ventral surfaces of the transverse processes of the fifth vertebra, it is probable that the lamina is formed solely by the ossification of the superficial coat of the air-bladder.

There can be but little doubt that the radial nodules are independent ossifications of the tunica externa in relation with the skeletal attachments of the radially disposed fibres converging from the concavities of the crescentic processes of the tripodes towards the complex centrum, which may either permanently retain their close fibrous connection with the centrum or become ankylosed thereto. RAMSAY WRIGHT (43) has shown that the crescentic process of the tripus, or at all events the inwardly curved portion which is imbedded in the dorsal wall of the bladder, is also formed as an ossification of the tunica externa, and only secondarily becomes continuous with the remainder of the ossicle. The same writer (*loc. cit.*) refers to the superficial ossifications investing the sides of the complex and fifth vertebral centra as "developed in connection with the air-bladder." If this be so the ossifications are obviously due to the conversion into bone of the outer stratum of that part of the tunica externa of the dorsal wall of the anterior chamber which is moulded and adherent to the lateral and ventral surfaces of these centra, and the fact that the ossifications are always co-extensive with that part of the dorsal wall which is represented by little more than the tunica interna, and certainly appear to replace the tunica externa in that region, confirms this conclusion.\* It would seem, therefore, a legitimate inference that these ossifications are due to the conversion into bone of the primitively more extensive, purely fibrous attachments of the posterior pillars to the lateral and ventral surfaces of the complex and fifth centra† in much the same way that the oblique lateral ridges and the dorsal laminæ are ossifications in the skeletally attached portions of the superficial coat. It may be also concluded that all

\* Recently SÖRENSEN (37) has more precisely shown that in *Platystoma* the superficial ossifications do result from the ossification of the tunica externa in the way we have suggested, and in this Siluroid may even form the greater part of the complex centrum. The same writer is of opinion that the inner layer of the peritoneum (la plèvre), or what we have referred to as the superficial coat of the bladder, is also concerned in the formation of these ossifications. As illustrating the contagious nature of this tendency to ossification, it may be mentioned that SÖRENSEN further concludes that the lateral ridges bounding the aortic groove are, in part at least, due to the ossification of the walls of the aorta itself, which may, as in *Platystoma*, even lead to the formation of a complete bony aortic canal.

† SÖRENSEN'S statement (*loc. cit.*) that in *Platystoma* the fibres in the superficial ossifications are so disposed that they exactly coincide with the direction of the fibres forming the forward extension of the posterior pillars into the dorsal wall of the anterior chamber supports this suggestion.

such adventitious ossifications as those above mentioned are invariably formed in connection with the attachments of the bladder to fixed or movable parts of the skeleton, and that such attachments were originally wholly fibrous, but subsequently became invaded by bony deposit.

The post-temporal plates, which so efficiently buttress the lateral portions of the anterior wall of the anterior chamber (*e.g.*, *Macrones*, &c.) seem to have been formed by the extension of ossification from the inferior limb and stem of the post-temporal into the aponeurotic membrane and the lateral portions of the transverse membrane; and in these instances (*e.g.*, *Macrones aor*) where the wall of the bladder which is applied to these plates is exceptionally thin it is at least possible that ossification of the tunica externa has contributed to their growth.

The various subvertebral processes which probably subserve a similar function, in part, at least, owe their formation to an extension of the superficial ossifications of the complex centrum into the mesial portion of the transverse membrane.

The peculiar crescentic distal extremities of the transverse processes of the fourth vertebra, which in some Siluroids (*e.g.*, *Macrones*, *Liocassis*, *Bagrus*, &c.) partially encircle the post-temporal plates, are almost certainly formed by a similar extension of bony deposit from their proper vertebral portions into the lateral regions of the transverse membrane, the transition from the bony to the fibrous structure being readily traceable.

SÖRENSEN (*loc. cit.*) has shown that the terminal plates of the "elastic-spring" apparatus are often formed in a precisely similar fashion. In *Malapterurus* for example, he concludes that these structures are due solely to the ossification of the transverse membrane (or "la plèvre"), but in such forms as *Synodontis* and *Doras* ossification implicates the outer stratum of the tunica externa of the air-bladder as well. Our own investigations enable us to state that *Auchenipterus*, *Oxydoras*, *Pangasius djambal*, and *P. Buchananii* resemble in this respect the two last-mentioned genera, while *P. juaro* and *P. macronema*, on the contrary, agree with *Malapterurus* in that the plates are formed by the ossification of the transverse membrane alone.

The formation of bony deposits in the proper walls of the air-bladder or in its superficial coat has probably been determined by physiological considerations, and generally with the object of securing either a firm or more extensive connection of the walls of the air-bladder to adjacent fixed or movable skeletal elements, or a more effective buttressing of certain regions, and their significance from this point of view will be discussed in a future section of this paper.

Although we have never been able to detect the presence of intrinsic muscular fibres in the walls of the air-bladder, powerful extrinsic muscles are present in several Siluroids. In *Platystoma tigrinum*, *Pimelodus maculatus*, *P. ornatus*, and *Piramutana piramuta*, a powerful muscle takes origin from the posterior face of the skull, on each side of the foramen magnum, and is inserted into nearly the whole extent of the corresponding half of the ventral surface of the anterior chamber. As the

contraction of these muscles must forcibly compress the anterior chamber, we have termed them the "compressor muscles" of the air-bladder. They probably occur in many other Pimelodinæ, but, so far as our investigations are concerned, are confined to that group.

The presence of compressor muscles is invariably associated with the existence of a pair of much smaller muscles which arise from the exoccipitals, and are inserted into the anterior wall of the anterior chamber of the bladder. The tendon of each muscle has its insertion into the anterior wall immediately external to the complex centrum, and the insertion coincides with the extension of a slip of fibres from the inner surface of the anterior wall to the ventral ridge and concave inner margin of the crescentic process of the tripus. As the contraction of these muscles must evidently have the effect of limiting the violent excursions of the tripodes which might otherwise take place when the anterior chamber is forcibly compressed by the contraction of its compressor muscles, we have suggested for each the name of "tensor tripodis."

An "elastic-spring" apparatus, provided with powerful protractor muscles, has already been described by JOHANNES MÜLLER as existing in the South American genera *Auchenipterus*, *Doras*, and *Euanemus*, and in the African Siluroids *Synodontis* and *Malapterurus*. To this list our investigations enable us to add the South American form *Oxydoras brevis*, and the East Indian species *Pangasius Buchanani*, *P. djambal*, *P. juaro*, and *P. macronema*. The absence of this mechanism in one species of *Pangasius*, viz., *P. micronema*, while present in all the remaining species of the genus that came under our notice, is an interesting and noteworthy fact.

Two points in connection with this apparatus may be noted, first, the reception of the outer margins of the tripodes into grooves between the terminal plates and their flexible and elastic roots, whereby the forcible compression of the air-bladder which follows the recoil of the plates, is prevented from imparting a too violent shock to the Weberian ossicles and the fluids of the internal ear; secondly, the geographical distribution of these fishes in which the mechanism is present, affords an additional instance of the singular and exceptional resemblances that have been noted between the South American, African, and East Indian faunas.

The extent to which those species with an "elastic-spring" mechanism differ from other S. normales is subject to some variation. Thus, in *Malapterurus*, *Pangasius juaro*, and *P. micronema*, the transverse process of the fourth vertebra retains both its characteristic divisions, although the anterior on each side forms an elastic spring, and the terminal oval plates of the mechanism are formed by the ossification of the transverse membrane alone. In *Pangasius djambal*, *P. Buchanani*, *Synodontis*, and *Doras* a further modification is introduced in the formation of the terminal plates from both the transverse membrane and the tunica externa, but the transverse process still retains a well-developed posterior division. Finally, *Auchenipterus* and *Oxydoras*, while agreeing with the last-mentioned Siluroids in the mode of formation of the terminal plates, differ from them in that the modified transverse process has

lost all trace of a posterior division, and the corresponding process of the fifth vertebra has atrophied altogether, or is rudimentary.

The evolution of the mechanism presents no difficulty, inasmuch as the necessary factors are obvious in many Siluroids. The anterior division of the transverse process of the fourth vertebra is often flexible (*e.g.*, many Arioid genera), even while retaining its normal articular relations with the post-temporal, and in other Siluridæ (*e.g.*, *Macrones*) it not infrequently happens that the terminal portion of the process is in part formed by the ossification of the transverse membrane, while the protractor muscles can readily be regarded as derivatives from the anterior section of the dorso-lateral musculature which passes over, and is partially inserted into, the dorsal surfaces of the modified anterior transverse processes, on its way to the posterior face of the skull.

We were at one time tempted to think that the post-temporal plates of *Macrones* and the allied genera might represent a form of "elastic-spring" mechanism. Both in their relations to the anterior wall of the air-bladder and their growth as ossifications of the transverse membrane, and the outer stratum of the tunica externa, these plates resemble the terminal expansions of an "elastic-spring" apparatus, but that they have the same functional significance is extremely doubtful. There are no special muscles for their protraction, nor any arrangement for elastic recoil. Whatever power of backward or forward movement they possess must be very slight, and must depend entirely on the corresponding swing of the loosely articulated post-temporal bones in conjunction with the whole of the pectoral girdle, the mobility of which is certainly well marked in these as in many other Siluridæ. But it is extremely improbable that such pendulum-like antero-posterior movements of the pectoral girdle can have much effect on the post-temporal plates, seeing that their inner and ventral margins are closely attached by ligamentous fibres and by the dorsal edge of the transverse membrane to the crescentic distal portion of the modified transverse process. The connection is perhaps not so rigid but that it admits of a very slight forward or backward movement of the plates to an extent which in no case exceeds 1 mm., at all events in spirit preserved specimens. So slight a range of movement can scarcely be regarded as likely to produce any appreciable effect either on the air-bladder or its gaseous contents. For these reasons we prefer to consider the plates merely as bony buttresses for the purpose of effectually damping the anterior wall of the bladder; they consequently aid in restricting any movements of vibration, or expansion and contraction, solely to the lateral walls of the anterior chamber.

In addition to those genera and species that we have either been able to examine for the first time, or to revise, there are several others which, from the description of various writers, must also be referred to the Siluridæ normales; these are the genera *Hara*, *Pseudeutropius*, *Olyra*, *Chaca*, *Piratinga*, *Sorubim*, *Callophysus*, *Synodontis*, *Doras*, and certain species of *Platyostoma* and *Arius*. The details given of the

structure of the air-bladder in these forms are for the most part but scanty, and, as a rule, are only sufficient to enable us to infer that the organ is normally developed, although in several instances they certainly furnish additional illustrations of the polymorphic condition of the air-bladder in different Siluroids. Skeletal modifications are but seldom referred to except by MÜLLER in the case of *Synodontis*, *Eucanemus*, and *Doras* where an "elastic-spring" apparatus is present, and in no instance is there any reference to those portions of the internal ear which are specially related to the Weberian mechanism.

With regard to the genera *Hara*, *Olyra*, *Pseudeutropius* (DAY, *loc. cit.*) and *Chaca* (CUV. and VAL., *loc. cit.*) nothing is known beyond the fact that the air-bladder is well developed and not enclosed by bone. *Platystoma fasciatum*, *P. coruscans*, and *Callophysus* are remarkable for the variable development of the curious cæcal appendages attached to the air-bladder. We have elsewhere described the antero-lateral cæca of *Platystoma tigrinum*, and according to JOHANNES MÜLLER (*loc. cit.*) precisely similar structures are also present in *P. fasciatum*, but in *P. coruscans* it would appear, on the same authority, that such appendages are entirely wanting. On the other hand, in *Callophysus* cæcal appendages are exceptionally well developed and form an elegant wreath surrounding the lateral margins of the bladder. In certain other Pimelodinæ these structures are entirely absent. With the exception of the Pimelodinæ the only other Siluroid known to possess such appendages is *Doras maculatus*, which, according to SÖRENSEN (*ante*, p. 165), has a fringe of branching cæcal tubules surrounding the lateral margins of the air-bladder. Among the variations in the structure of the air-bladder recorded by MÜLLER may be mentioned the transverse constriction of the organ into three intercommunicating and longitudinally arranged compartments in *Arius emphysetus*—a variation which was certainly not met with in any of the Ariinæ examined by us. In the Pimelodinæ *Piratinga filamentosa* is also said by MÜLLER to have the air-bladder divided into two sacs, lying one behind the other; both are said to be cellular, but while the anterior sac is in connection with the œsophagus by a ductus pneumaticus, the posterior one has no communication either with the œsophagus or with its fellow in front.

The presence of muscles in connection with the air-bladder is confined, so far as our experience is concerned, to the Pimelodinæ, but, according to CUVIER and VALENCIENNES (*loc. cit.*), powerful extrinsic muscles are also present in *Arius Milberti* and *A. cælatus*. *A. Milberti* we have had no opportunity of examining, but in *A. cælatus* there is no trace whatever of such muscles, and, as the same remark applies also to every one of the eleven species of *Arius* dissected by us, we fancy that the statement quoted is as erroneous in the case of *A. Milberti* as it certainly is with regard to *A. cælatus*. The same writers have also described extrinsic muscles in connection with the air-bladder of *Elurichthys Gronovii*, of which two on the ventral surface are said to be able to compress the bladder. The only species of this genus (*A. longispinis*) that we dissected assuredly had no such structures.

2. *Siluridæ Abnormales.*

Omitting for the present any reference to such extremely aberrant forms as *Hypophthalmus*, *Rhinelepis* and the various Loricaroid genera, we confine our summary of this group to the various genera and species that came directly under our notice. These are:—*Clarias*, *Saccobranhus*, *Eutropiichthys*, *Cryptopterus* (two species), *Ailia*, *Schilbichthys*, *Silondia*, *Acrochordonichthys*, *Akysis*, *Pimelodus* (two species), *Bagarius*, *Glyptosternum*, *Eucliptosternum*, *Callomystax*, and *Cetopsis*.

In all these forms the series of rigidly interconnected vertebræ includes only the first, the complex, and the fifth vertebræ, the sixth being almost invariably free. The rigid articulation of the anterior vertebræ with the skull is as marked in this group as in the preceding one, and is brought about by substantially similar means. The centrum of the first vertebra is usually somewhat more rudimentary than in the normal forms, and neither it, nor the basioccipital, nor the complex centrum, are ever provided with accessory articular processes. Subvertebral processes are never developed. The complex vertebra has the same general characters as in the foregoing group. The spinous processes of the third and fourth vertebræ form, as a rule, a continuous thin lamina of bone, usually articulated along its dorsal edge with the supra-occipital spine, and it but rarely happens that the spine of the fourth is cleft for the support of the first interspinous bone which, therefore, is usually supported by the bifid spine of the fifth vertebra. Superficial bony deposit may thicken the sides of the complex and fifth vertebral centra, and even invest the lateral and ventral surfaces of the first centrum, or, in addition, extend on to the basioccipital, partially or completely obscuring the various intervertebral sutures. A median groove for the dorsal aorta is generally indicated, but rarely (*e.g.*, *Pimelodus sapo*) becomes converted into a complete canal for any portion of its extent. Asymmetrically developed cardinal grooves are almost always present, but in one or two instances (*e.g.*, *Callomystax*) are absent. Dorsal laminæ and radial nodules are usually, but not invariably, present; exceptionally, the dorsal laminæ have no connection at their inner extremities with the complex centrum (*e.g.*, *Clarias*, *Glyptosternum*), and when this is the case the radial nodules may be absent (*e.g.*, *Glyptosternum*), or confluent with the inner extremities of the dorsal laminæ, and widely separated from the complex centrum (*e.g.*, *Clarias*).

The most characteristic of the various skeletal modifications exhibited by this group is the formation of more or less complete osseous grooves, recesses, or funnels for the partial or complete enclosure of the air-bladder. Such recesses are formed by the transverse processes of the fourth vertebra, either singly or in conjunction with those of the fifth vertebra, and vary greatly in depth, and in the extent to which they are surrounded by bone. They may be comparatively shallow and widely open on the ventral surface (*e.g.*, *Bagarius*, *Akysis*, *Acrochordonichthys*, &c.); or may take the form of deep, transversely disposed grooves, contracted distally, but somewhat

expanded proximally (*e.g.*, *Pimelodus sapo*, *P. pulcher*, *Eutropiichthys*, *Schilbichthys*, &c.); or they may partake of the nature of transversely-arranged bony cylinders or funnels, open distally in the dry skeleton, closed in the fresh specimen by the lateral cutaneous areas, but otherwise with more or less complete osseous walls (*e.g.*, *Clarias*, *Saccobranchus*, *Callomystax*, *Cetopsis*, &c.). The transverse processes of the fourth vertebra always form the dorsal and anterior walls of the recesses and sometimes, in addition, the posterior wall also; rarely do they alone completely enclose tubular recesses (*Cetopsis*): more frequently the posterior walls are formed by the transverse processes of the fifth vertebra (*e.g.*, *Callomystax*, *Clarias*, &c.). Exceptionally, a slender, lateral bony outgrowth (ventral process) from each of the superficial ossifications investing the sides of the complex centrum may become attached to the ventral wall of the corresponding air-sac (*e.g.*, *Bagarius* and *Glyptosternum*), or, as in one or two instances (*e.g.*, *Clarias*), the outgrowths may be strongly developed, and form no inconsiderable portion of the ventral walls of the two osseous funnels. The formation of a horseshoe-shaped recess by the transverse processes of the fourth vertebra in conjunction with similar but more extensive, plate-like, lateral outgrowths from the superficial ossifications, which is open laterally and behind in the dry skeleton, occurs in one genus only (*e.g.*, *Ailia*). When not completed ventrally by bone the recesses are usually closed by a tough fibrous membrane which also invests the corresponding walls of the contained air-sacs (*e.g.*, *Bagarius*, *Glyptosternum*, and many others). This membrane we regard as the result of a special development of the superficial connective tissue which in all normal Siluridæ invests the external surface of the air-bladder, and is continuous anteriorly with the transverse membrane. In whatever way the osseous capsules or recesses may be formed they are almost always closed laterally by the external skin (lateral cutaneous areas), never, as in the more aberrant Loricaroid genera, by the post-temporals.

In none of the genera examined by us was the encapsulation of the air-bladder by bone effected wholly or in part by the actual ossification of its *proper* wall, or tunica externa, although such instances do occur in other S. abnormales (*e.g.*, *Hypophthalmus*, and probably *Acanthicus*), and in several Cyprinidæ (*e.g.*, *Cobitis*). In *Callomystax* it is probable that the ventral walls of the osseous funnels are in part formed by the extension of ossification from the decurved anterior margins of the transverse processes of the fourth vertebra into the fibrous sheet which often closes the ventral openings of the recesses, and it is also possible that in many other S. abnormales the exceptional width and downward curvature of the margins of these processes are due to the same cause. The lamellar outgrowths which form the ventral walls of the horseshoe-shaped recesses in *Ailia* are also probably due to an extension of ossification from the superficial bony deposit on the surface of the complex centrum into the same fibrous membrane; and a similar origin may possibly be ascribed to the ventral processes of *Clarias*,\* *Glyptosternum*, and *Bagarius*.

As a rule the post-temporal retains its normal relations to the skull and to the

\* See also SÖRENSEN (37).



transverse process of the fourth vertebra. The anterior wall of each bony recess for the air-bladder articulates at its distal end with the post-temporal stem, and frequently also along its anterior face with the inferior limb of the same bone (*e.g.*, *Glyptosternum*); sometimes the inferior limb is extremely slender (*e.g.*, *Bagarius*); exceptionally, it becomes quite rudimentary and loses its usual articulation with the basi-occipital (*e.g.*, *Clarias*).

The skull presents no special modifications in any of the fifteen genera above mentioned. Whatever changes the membranous labyrinth of the internal ear may undergo, the mode of formation and the relations of the cavum sinus imparis, the atria sinus imparis, and the recesses for the sacculi are essentially the same as in the Siluridæ normales.

The condition of the air-bladder in this group is singularly varied, and in proportion to the size of the fish is always small and often diminutive. Many of its more characteristic features are clearly the results of atrophy and degeneration. The principal modifications appear to be due to the partial or complete suppression of the lateral chambers, and the partial or complete subdivision of the anterior chamber into two laterally situated cavities or air-sacs, either by the solidification of the mesial portion of the bladder, or by more or less complete longitudinal constriction. In all cases the atrophied bladder is partially or completely enclosed within bony recesses. In one or two instances (*e.g.*, *Schilbichthys*, and probably also *Eutropichthys*) the air-bladder, although solid mesially, nevertheless retains in each half traces of its original and normal division into anterior and lateral compartments, but the extreme thickness of its walls, and the small size of its internal cavities, afford sufficient proof of its degenerate and functionless condition. Solidification of the central portion of the bladder in one instance (*e.g.*, *Silondia*) has reduced the cavity of the organ to the condition of a circular canal surrounding a massive central pillar. Two species furnish examples of the extreme variability to which degenerate structures are liable. In one (*Ailia*) the air-bladder assumes the shape of a cylindrical horse-shoe, and is almost solid through the development of internal fibrous trabeculæ, except at its hollow forwardly-curved cornua; in the other (*Pimelodus sapo*) the organ is almost solid mesially, or at all events its original cavity is obliterated by the growth of a dense fibrous network, and of its two pairs of forwardly directed prolongations one only is hollow and receives the insertion of the tripodes. In another instance (*Cryptopterus micropus*, and possibly also *C. hexapterus*) the air-bladder consists of two partially separated lateral halves, but its degenerate character is betrayed by the partial obliteration of the cavities of the greatly reduced lateral compartments by a dense network of fibrous bundles. Such facts suggest that the partial obliteration of portions of the internal cavity of the bladder, and more especially the lateral chambers, by the development therein of anastomosing fibrous trabeculæ, often precedes their more complete suppression. But despite such exceptional variations in particular species or genera, the more frequent condition of the

air-bladder in this group is in the form of two simple, pyriform or globose, thin-walled, laterally placed air-sacs, which are either distinct or connected by an intermediate tubular portion (*e.g.*, *Glyptosternum*, *Eucliptosternum*, *Cetopsis*, *Bagarius*, *Akysis*, *Acrochordonichthys*, *Clarias*, *Saccobranchus*, and *Pimelodus pulcher*).

The skeletal attachments of the air-bladder to rigid portions of the skeleton exhibit as a rule much the same extent and kind of variation as we have already described in the case of the anterior chamber of the more normal Siluroids. In such forms as possess rudiments of lateral chambers, and of primary transverse and longitudinal septa, the attachments of the air-bladder to the anterior vertebræ are perfectly normal, and even in many genera where those structures are entirely wanting the skeletal attachments are often very similar to those of the normal Siluridæ. Thus in those cases in which the bladder is represented by two distinct or mesially intercommunicating air-sacs, the dorsal attachment of the primary transverse septum in the normal organ is represented either by the attachment of the dorsal edge of the median portion of the posterior wall to the ventral surface and sides of the complex centrum (*e.g.*, *Pimelodus pulcher*), or by a similar attachment of the corresponding margin of the posterior wall of each lateral air-sac to the hinder margin of the transverse process of the fourth vertebra, or to the ventral surface of the corresponding process of the fifth vertebra in those cases in which the latter process participates in the formation of the osseous recesses (*e.g.*, *Bagarius*, *Clarias*, *Glyptosternum*, &c.). The median and tubular portion of the air-bladder, when present, is always thin-walled, and its firm connection with the ventral surface of the complex centrum evidently corresponds to the skeletal attachment of the thin medio-dorsal portion of a normal anterior chamber (*e.g.*, *Clarias*). The same remark will apply also to such cases in which the median portion of the constricted air-bladder is represented by a band of fibrous tissue, without any lumen, passing from one air-sac to the other, and firmly attached to the ventral surface of the complex centrum (*e.g.*, *Bagarius*, *Glyptosternum*, and others). Whether the median tubular portion of the air-bladder be present or absent, the inner portion of the anterior wall of each air-sac is almost invariably attached to the contiguous lateral surfaces of the complex centrum, or to the radial nodule, or even to both, after the fashion of the anterior pillars of the normal bladder. Occasionally also, as in such normal forms as *Arius* and its allies, the outer stratum of the anterior wall of each air-sac may be dorsally connected with the decurved anterior margin of the transverse process of the fourth vertebra (*e.g.*, *Bagarius*, *Glyptosternum*, and *Akysis*). As a rule, however, in the limited number of instances where the air-bladder is almost completely surrounded by its osseous capsules, the rigid skeletal attachments of the former are not so obvious as in those cases in which the bony investment is but partial (*e.g.*, *Callomystax*, *Cetopsis*, &c.). Broadly speaking it may be affirmed that reduction in the size of the air-bladder, and its structural degeneration in other respects, do not to any great extent

affect its normal attachments to rigid portions of the axial skeleton, except in certain instances where encapsulation by bone is more complete than is usually the case.

In addition to considerable variations in the thickness of its walls, the relations of the air-bladder to the Weberian ossicles are subject to important variations in different genera and species.

In certain genera (*e.g.*, *Bagarius*, *Glyptosternum*, *Eucliptosternum*, *Akysis*, and *Acrochordonichthys*) the dorsal wall of each air-sac has so far degenerated that it is extremely improbable that the few scattered fibres that alone remain can exert any influence on the tripus during the distension or contraction of the bladder. In most of the remaining genera, however much they may be modified in other respects, the walls of the air-bladder are structurally complete, and the convergence of the fibres forming the antero-lateral, lateral and dorsal walls of each air-sac to their insertion into the crescentic process of the tripus takes place in much the same way as in the normal Siluridæ. There would seem, however, to be some definite relation between the extent to which the air-bladder retains its structural integrity, and its apparently functional connection with the tripodes, and the extent to which it is encapsuled by bone. When the dorsal walls of the air-sacs have undergone more or less complete degeneration, and have wholly or largely lost their normal attachments to the tripodes, the air-bladder is but slightly enclosed within comparatively shallow recesses or grooves on the ventral surfaces of the transverse processes of the fourth and fifth vertebræ. The partial encapsulation in such cases may be simply due to the fact that reduction in the size of the only portion of the air-bladder that persists, *viz.*, the anterior chamber, has been accompanied by a corresponding contraction and curvature of the modified transverse processes, which are normally moulded to the convexity of its anterior and dorsal surfaces. On the contrary, in nearly all cases in which the air-bladder retains much of its structural integrity, and, at the same time, its anatomical connection with the tripodes, it is always more completely encapsuled by bone than when the contrary is the case (*e.g.*, *Callomystax*, *Cetopsis*, and *Clarias*). In such instances, the reduced air-bladder is either enclosed within deep groove-like recesses with greatly contracted outer or distal extremities, or within tubular or funnel-like cavities almost completely surrounded by bone, and the encapsulation always seems to be more complete than can be accounted for by the mere contraction of the associated skeletal elements round an atrophying air-bladder.

Notwithstanding the reduced condition of the air-bladder, the Weberian ossicles almost always retain their normal size relatively to that of the Fish, but the comparatively slight modifications which they present in other respects are invariably in the direction of degeneration. Claustera are occasionally absent, and even when present are but very feebly developed spicules of bone. As a rule, the scaphium has no ascending process, but only spatulate and condylar processes. The intercalarium may be absent (*e.g.*, *Clarias*), in which case the interossicular ligament is extremely short, or is represented by a very small bony nodule in the usual position; horizontal and

ascending processes are invariably wanting. As regards its position, the relations of the crescentic process of the tripus to each lateral air-sac are precisely similar to those of the same structure in each half of the anterior chamber in a normal Siluroid, but in shape it is variously modified. Very rarely does it retain its characteristic sickle-like form, more frequently it is nearly straight, with a pointed distal extremity (*e.g.*, *Bagarius*), or but slightly curved (*e.g.*, *Glyptosternum*); exceptionally (*e.g.*, *Clarias*), the crescentic process is curiously angulated and heeled. A ventral ridge is rarely present—a fact which must be associated with the general thinness of the walls of the air-bladder, and the occasional degeneration of those fibres which normally converge from the dorsal wall and are inserted into it. The articular process of the tripus is usually long and tapering, with a pointed distal extremity, and retains its usual relations with the anterior portion of the complex centrum. The anterior process presents no special characters. Radial fibres can generally be detected, but in some cases are less obviously specialized than in others, and, where radial nodules are absent, pass directly from the lateral surfaces of the complex centrum to the inner or faintly concave margins of the crescentic processes of the tripodes. On the other hand, in those Siluroids in which the dorsal walls of the air-sacs have degenerated, radial fibres, if present at all, are very feebly developed (*e.g.*, *Bagarius*, &c.).

Lateral cutaneous areas are almost invariably well marked, and, as a rule, close the distal openings of the osseous recesses in which the air-bladder is lodged, but their relation to the outer walls of the latter vary considerably. In some forms the two structures are in close contact (*e.g.*, *Clarias*, *Callomystax*), but more frequently they are separated by a considerable interval, which is usually occupied by the lateral lobes of the liver, or even, in addition, by the mesonephros or its anterior lymphoid portion—the “head-kidney.”

A ductus pneumaticus may be present or absent. It is usually present when the laterally-situated air-sacs are connected by an intermediate tubular portion (*e.g.*, *Clarias*, *Saccobranchus*, and others), but it is absent when the two sacs are completely separated or connected only by a solid fibrous band (*e.g.*, *Bagarius* and *Glyptosternum*). Rarely is it represented by a solid fibrous cord.

Our investigations into the structure of the auditory organ in this section of the family are not so complete as we could desire, and our regret is the greater because it would have been extremely interesting to ascertain how far the atrophy and degeneration of the air-bladder is correlated with similar retrogressive changes in those portions of the membranous labyrinth which are functionally related in the Weberian mechanism. That our specimens were not sufficiently well preserved to admit of accurate research on this point, is due to the fact that many of them had been preserved for some considerable time without being previously opened to secure the proper permeation of the specimens by the preservative fluids. In some genera (*e.g.*, *Bagarius*, *Glyptosternum*, *Eucliptosternum*, *Acrochordonichthys*, and *Akysis*) we entertain but little doubt that degeneration of the air-bladder is accompanied by

corresponding retrogressive changes in the auditory organ, to the extent at least of the atrophy of the sinus endolymphaticus, although the ductus endolymphaticus still persists as a channel of communication between the two sacculi. We are also of opinion that the sinus is similarly wanting in other Siluridæ abnormales—as, for example, in *Pimelodus sapo*; but, for reasons already stated, we hesitate to speak decisively in this as well as in some other instances about which we entertain a similar belief. On the other hand, there are several genera of which we entertain no doubt as to the presence of a sinus endolymphaticus, but in which the membranous labyrinth appears to be in every respect essentially similar to that of the more normal Siluridæ (e.g., *Clarias*, *Saccobranchnus*, *Pimelodus pulcher*, &c.). It may be affirmed, therefore, that, while in some instances the membranous labyrinth would seem to have retained its normal structure, there are certainly other cases in which degeneration of the air-bladder has been accompanied by a corresponding simplification of those portions of the internal ear which are normally brought into physiological relation with it through the medium of the Weberian ossicles.

In addition to the Siluridæ abnormales already mentioned as forming the special subjects of our investigations, there are several other genera which, on the authority of various writers, must be referred to the same series.

Thus, on the authority of DAY (9), the Indian genera *Sisor*, *Amblyceps*, *Pseudocheneis*, and *Exostoma* are Siluroids in which the air-bladder is diminutive and bone-encapsuled—a conclusion which is in harmony with their hilly habitat and Loach-like form.

JOHANNES MÜLLER'S references (*loc. cit.*) to the air-bladder of the South American Siluroid *Ageniosus militaris*, and of *Heterobranchus*, warrant a similar conclusion with regard to these genera.

On the authority of REISSNER (*loc. cit.*), the following genera belonging to GÜNTHER'S group Hypostomatina, viz., *Loricaria*, *Plecostomus*, *Callichthys*, and *Acanthicus*, must also be regarded as S. abnormales, and, as the genera *Arges* and *Brontes* are but the naked allies of these cuirassed Loricaroid forms, it is extremely probable that they must also be added.

According to SAGEMEHL (*loc. cit.*) the Hypostomatous genus *Trichomycterus* also possesses a diminutive air-bladder encapsuled by bone, and as *Eremophilus* is a near ally it may be conjectured that its air-bladder is in a similar condition.

Finally, it has been proved by RAMSAY WRIGHT (44) that in *Hypophthalmus* the air-bladder is degenerate and bone-encapsuled.

It follows, therefore, that in addition to the thirteen genera which we have been able to revise, there must also be included twelve others, and with some probability the three genera, *Arges*, *Brontes*, and *Eremophilus*. So that of the 116 genera enumerated in the British Museum catalogue of the family, certainly twenty-five, and probably twenty-eight, are referable to the S. abnormales. In these totals we have

not included the genera *Pimelodus* and *Cryptopterus* in which only two or three species are at present known to possess degenerate air-bladders.

In certain of the preceding genera the condition and relations of the air-bladder, and the character of the correlated skeletal modifications, are sufficiently well known to admit of comparison with those dissected by us. Such a comparison clearly proves that many of the former exhibit structural modifications of an extremely interesting character. On the other hand there are others of which scarcely anything is known beyond the bare fact that the bladder is more or less rudimentary and encapsuled by bone, and no data are available for comparison with other and better known types.

Of the Hypostomatinæ about which any reliable evidence exists as to the structure and relations of the air-bladder and Weberian mechanism, we may first of all refer to a series of genera which in future we shall term the Loricaroid types; under this head we include *Loricaria*, *Plecostomus*, and *Callichthys*. There are certain points with regard to these types which are still obscure, and more particularly the structure of that portion of the internal ear which is specially related to the Weberian mechanism, but certain facts may, nevertheless, be mentioned as affording a basis for comparison, on the one hand, with such *S. abnormales* as we have been able to examine, and on the other, with such extremely modified forms as *Acanthicus* and *Hypophthalmus*.

From REISSNER'S observations on *Loricaria*, *Plecostomus*, and *Callichthys*, and from certain facts which our own investigations have enabled us to add, it may be inferred that in all these types an air-bladder is present in the form of two laterally situated sacs with structurally complete, but extremely thin walls, and connected by an intermediate narrow tubular portion, supported in *Callichthys* and *Plecostomus*, and possibly in *Loricaria* also, by an arch-shaped spicule of bone, similar to what REISSNER has termed the "processus bijugus" in *Acanthicus*. So far as *Plecostomus* is concerned we could detect no trace of a ductus pneumaticus, and of the remaining genera our limited material was too badly preserved to admit of the point being determined. The air-sacs are completely enclosed within osseous capsules formed by the so-called dorsal and ventral laminæ of the transverse processes of the fourth vertebra, precisely as described by RAMSAY WRIGHT in the case of *Hypophthalmus*, and the lateral or distal apertures of the two capsules are almost completely closed by the post-temporals. All the anterior vertebræ in front of the fifth, with, perhaps, the exception of the centrum of the first which may be absent, are indistinguishably anchylosed into a "complex" vertebra,\* which in turn is firmly attached, if not actually anchylosed, to the posterior face of the skull. From the mode of articulation of the complex centrum with the basioccipital, it may be concluded, that, with the possible exception of *Callichthys*, nothing comparable to the singular forward dislocation of the coalesced anterior vertebræ, which is so characteristic of *Hypophthalmus*, has taken place in these Siluroids. But little is certainly known as to the structure of the auditory organ, but it is clear that the two sacculi are closely

\* From SÖRENSEN'S account (37) of *Plecostomus*, it is possible that even the fifth vertebra may be included.

apposed in the median line, and occupy two shallow depressions, separated by a faint median ridge, on the cranial surface of the basioccipital. The sacculi may have a fibrous investment dorsally, but it is certain that they are not roofed over by horizontal ingrowths from the exoccipitals as is the case with all the other *S. abnormales* that we dissected. It is also due to the absence of such ingrowths that, with the possible exception of *Callichthys*, the walls of the cavum sinus imparis are everywhere fibrous, except where it rests on the dorsal surface of the basioccipital. Whether a sinus endolymphaticus is present or absent has not yet been determined, but its presence in *Acanthicus* suggests that it may also be present here. The Weberian ossicles are very similar to those of other *Siluridæ abnormales*. The scaphium is a small concavo-convex ossicle without ascending or condylar processes, and lies altogether within the neural canal. The intercalarium is absent. The tripus has but a slightly curved crescentic process for insertion into the wall of the corresponding air-sac. No mention of claustra is made by REISSNER, nor could we detect any trace of these ossicles.

From this brief summary it is obvious that the Loricaroid types are in many respects widely different from those *S. abnormales* that came more directly under our notice, and exhibit a combination of characters in common which no doubt represents a further and more extreme modification of the type of structure exhibited by the latter. From this point of view the most important of the Loricaroid features are, (1.) the absence of a distinct separable centrum to the first vertebra. In all other Ostariophyseæ this centrum can be readily recognized, although in the *Siluridæ* it may be much smaller than any of the adjacent normal centra; but in the Loricaroid genera it has either undergone complete suppression, or has fused behind with the complex vertebra. (2.) The mode of formation of the osseous capsules for the air-bladder by what have hitherto been described as the dorsal and ventral laminae of the transverse processes of the fourth vertebra, and by the bones forming the posterior face of the skull. It is by no means improbable that this method is partly the direct result of the reduction in size and concrescence of the anterior vertebræ, and the close relation of the modified transverse processes to the skull which is thus brought about, and partly to the further extension of a modification already indicated in other and less aberrant *Siluridæ*. The so-called "dorsal lamina" of the modified transverse processes in the Loricaroid forms, is clearly the equivalent of the entire process in a normal Siluroid, and like the latter has its origin from the neural arch of its vertebra. The downgrowth of the lamina to buttress the front wall of the air-bladder as in other abnormal *Siluridæ* is here unnecessary, inasmuch as the close relation of the bladder to the posterior face of the skull enabled the latter to be utilized in forming the anterior wall of the investing bony capsule. The so-called ventral lamina is probably to be regarded not as a portion of the transverse process as described by RAMSAY WRIGHT, but rather as a further development of the peculiar outgrowth from the superficial ossification investing the lateral surfaces of the complex centrum, which, as a rudiment, is apparent in *Glyptosternum* and *Bagarius*, but is more

extensively developed in *Clarias* and *Ailia*. A special development of this process ("ventral process") and the union of its posterior margin with the corresponding edge of the modified transverse process, while the anterior margins of both remain distinct from each other but blend with the posterior face of the skull, would eventually lead to the enclosure of the air-bladder within bony capsules exactly similar to those of the Loricaroid Siluridæ.\* This explanation renders necessary the assumption that the modified transverse processes of the fourth vertebra have each a double origin from the vertebra in these Siluroids, and, moreover, explains the formation of their osseous capsules as being due to the further extension of a modification already initiated in other and less aberrant *S. abnormales*. (3.) The imperfect closure of the saccular recesses and the cavum sinus imparis by bone. The deficiencies of the Loricaroid forms in this respect must be regarded as due to the atrophy of the horizontal plates of the exoccipitals by which these cavities are usually roofed. A transitional stage in this process is apparently represented in *Hypophthalmus*. (4.) The suppression of the intercalaria and claustra. Although a constant character in those Loricaroid forms that have yet been examined, the absence of one, or even both, of these elements is not unknown in the less abnormal members of this section of the family.

The Hypostomatous genus *Acanthicus*, while in some respects resembling *Loricaria* and its allies, in others exhibits certain characteristic features of its own. In common with the preceding forms, the air-bladder is longitudinally constricted into two laterally situated oval sacs with structurally continuous walls, and connected by an intermediate tubular portion which, as in several of the Loricaroid genera, is supported by a "processus bijugus." The presence of a ductus pneumaticus is uncertain. Each air sac is completely enclosed within an osseous capsule of corresponding shape, and, for a part of its extent, is situated dorsad to the first pair of ribs. What share the modified transverse processes take in the enclosure of the air-sacs is not clear from REISSNER'S account, but the shape and smooth rounded contour of the capsules certainly suggest that they are mainly, if not exclusively, formed by the ossification of the outer stratum of the tunica externa of the air-bladder itself, and that, unlike *Loricaria*, *Callichthys*, &c., and *Hypophthalmus* the transverse processes can have but little share in their formation—a conclusion which receives some additional support from the fact that the bladder is everywhere in close contact with its bony investment, and connected therewith by fibres passing from one to the other. REISSNER seems to compare the "processus auricularis" with the distal extremity of a modified transverse process, which in *Acanthicus*, as in the Cyprinoid *Cobitis fossilis*, is perforated by certain apertures through which the external skin is prolonged inwards and attached to the outer walls of the air-bladder; but it may also be the case that the "processus auricularis" is really the post-temporal, which here, as in the Loricaroid types, closes what, in the dry skeleton, would otherwise be an

\* See also SÖRENSEN'S account of *Plecostomus* (37).



aperture leading into the corresponding osseous capsule. It is difficult to judge from REISSNER'S description how far coalescence has affected the anterior vertebræ, and whether any forward dislocation has taken place. His "first" vertebra, as we have pointed out (p. 178), is probably a "complex," which may include the first to the fifth vertebræ, inclusive, but there is also the alternative that the vertebra has the same value as an ordinary "complex" in most other Siluridæ, although the possibility that the centrum of the first vertebra may also be included in it cannot altogether be left out of sight. We are of opinion that REISSNER'S "first" vertebra will ultimately be found to possess the same significance as in *Loricaria* and its allies, but a careful re-examination of this curious Siluroid is necessary before perfectly trustworthy conclusions can be arrived at. The cavum sinus imparis, the atrial cavities, and the sinus endolymphaticus are apparently normal so far as their mutual relations are concerned, and lie on the upper surfaces of the basioccipital and the anterior portion of the "first" vertebra. The relations of the scaphia to the lateral walls of the two atria would also seem to be normal. The dorsal wall of the cavum sinus imparis, however, must be fibrous, or at all events the cavum is not roofed in by horizontal plates from the exoccipitals; and in the fact that the sacculi occupy mere depressions in the cranial surface of the basioccipital, and are not surrounded by almost complete osseous capsules, *Acanthicus* also differs from *Hypophthalmus* and most other abnormal Siluridæ, and resembles the Loricaroid types. The relative positions of the sacculi, the cavum sinus imparis, the sinus endolymphaticus, and the atrial cavities almost negative the possibility of any forward dislocation of the anterior vertebræ into the cranial cavity having taken place. Clastra and intercalaria are probably absent, or at all events are neither figured nor mentioned by REISSNER. The scaphium, as in some other S. abnormales and in the Loricaroid genera, has neither condylar nor ascending processes, and, as is the case with the great majority of the abnormal types, the tripus has a straight or but very slightly curved "crescentic" process.

From this summary of the more salient features in the structure of its air-bladder and Weberian mechanism, it is clear that as regards the condition and mutual relations of the cavum sinus imparis, the atrial cavities, and the saccular recesses, the existence of a "processus bijugus," and possibly also in the relations of the anterior vertebræ to the skull, *Acanthicus* closely resembles the Loricaroid genera and differs from *Hypophthalmus*. In the mode of formation of the osseous capsules for the air-sacs, however, *Acanthicus*, while peculiar among the Siluridæ, distinctly resembles, as REISSNER suggests, the Cyprinoid *Cobitis fossilis*. On the other hand, the peculiar position of the posterior halves of the two air-sacs and their bony capsules, dorsad to the first pair of ribs in *Acanthicus*, has no parallel in any known Ostariophyseæ.

The last of these extremely aberrant Siluroids, *Hypophthalmus*, exhibits an extreme type of modification, of which the most noteworthy features are the complete fusion of

the first four vertebræ with one another and their partial coalescence with the fifth, and the telescoping of the three anterior vertebræ and the associated portions of the Weberian mechanism through the foramen magnum on to the upper surface of the basioccipital, so that all these structures lie wholly within the cranial cavity and dorsad to the osseous recesses for the sacculi which here, as in the normal Siluridæ, are roofed over by horizontal plates developed from the exoccipitals. With such singular modifications must also be mentioned the almost complete ankylosis of the conjoined and dislocated anterior vertebræ with the occipital portion of the skull, and the enclosure of the two completely separated air-sacs into which the air-bladder is divided within recesses formed by the so-called dorsal and ventral laminæ of the modified transverse processes above, behind, and below, and by the posterior face of the skull in front, while the lateral or distal apertures of the recesses are closed by the lateral cutaneous areas only, the post-temporals merely forming their anterior and ventral lips. The absence of a sinus endolymphaticus, although the ductus endolymphaticus still remains, the partially fibrous condition of the roof of the cavum sinus imparis, and the fact that, as a consequence of the forward dislocation of the anterior vertebræ, the scaphia form the side walls of the cavum sinus imparis instead of those of the atrial cavities, are also noteworthy features. Finally, may be mentioned the absence of a ductus pneumaticus, the partial ossification of the tunica externa of the inner half of each air-sac, and the fusion of the osseous cups so formed with the side walls of the neural canal in this region, and the presence of intercalaria and rudimentary claustra, in addition to a concavo-convex scaphium without condylar or ascending processes.

The condition of the air-bladder, Weberian mechanism and the associated skeletal structures in *Hypophthalmus* are such as to justify the conclusion that in this genus the structures in question, while in some respects more normal than in any of the Hypostomatinae at present examined, in others reach their extreme of retrogressive modification. In the relations of the post-temporals to the skull, to the pectoral girdle, and to the modified transverse processes, as well as in the fact that they do not close the external apertures of the osseous recesses for the air-sacs, *Hypophthalmus* closely resembles the less modified Siluridæ abnormales. A further resemblance to the latter is also shown by the enclosure of the two sacculi within bony recesses formed by the basioccipital and by horizontal plates derived from the exoccipitals, the partial roofing in by bone of the cavum sinus imparis, and the presence of intercalaria and claustra. The complete separation of the two air-sacs, the atrophy of the ductus pneumaticus, and the possible suppression of the sinus endolymphaticus, may also be paralleled by similar retrogressive modifications in such otherwise less abnormal genera as *Bagarius*, *Glyptosternum*, &c. The mode of formation of the osseous capsules for the air-sacs is almost identical with the means employed for the same object in the Loricaroid genera. On the contrary, in

the remarkable structural modifications involved in the forward dislocation of the anterior vertebræ and the associated portions of the Weberian mechanism into the cranial cavity, and in the combination of a partially ossified air-bladder with external osseous capsules, *Hypophthalmus* is unique among all S. abnormales which have so far been described, and represents the extreme of a series of modifications of which *Loricaria* and its allies exhibit the initial stages.\*

From the facts above-mentioned it may be concluded: (1) That the Hypostomatinae and Hypophthalminae exhibit the most extreme modifications which the air-bladder, Weberian mechanism and the correlated skeletal elements undergo in the Siluridæ. (2) That the modifications in question have to some extent taken place in the same direction, so that the two groups possess certain features in common, and, notably, the firm sutural union, or even partial ankylosis of the anterior vertebræ with the skull, and also, with one exception (*Acanthicus*), in the mode in which the osseous capsules for the air-bladder are formed; in the partial or complete atrophy of the bony roof of the cavum sinus imparis; and in certain other features which the two groups share with the less aberrant Siluridæ abnormales. (3) That the exceptional features so characteristic of certain genera, viz., the formation of complete bony capsules for the air-bladder by the actual ossification of its own walls in *Acanthicus*, and the peculiar relation of both to the first pair of ribs; and the singular dislocation of the anterior vertebræ in *Hypophthalmus*, are sufficient to prove that very striking variations may occur within the limits of the two groups.

A careful investigation of the remaining genera of the Hypostomatinae may bring to light other forms, some of which may prove to be even more, and others less, aberrant than those already known.

We have had no opportunity of dissecting the Indian genera, *Sisor*, *Exostoma*, and *Pseudecheneis*, which are the only Hypostomatinae that are not restricted to South America. Some doubt has been thrown on the correctness of their presumed relationship to this group, but the mode of formation of the osseous capsules for the air-bladder, and the extent of coalescence among the anterior vertebræ, should furnish decisive evidence on this point. It is unfortunate, therefore, that the only evidence available through DAY'S descriptions is confined to the bare fact that the air-bladder consists of two lateral sacs enclosed within bony capsules, no information being given about the special features so necessary for comparison with undoubted Hypostomatinae.

The singular air-bladder of *Ageniosus militaris* (MÜLLER, *loc. cit.*) bears a remarkable resemblance to that of such Cyprinidæ as *Cobitis* and *Botia*. Not only is the

\* As RAMSAY WRIGHT (44) points out, *Hypophthalmus* occupies a somewhat isolated position among Siluroids. GÜNTHER (15) forms for the genus a distinct sub-family. COPE (7) regards the genus as the type of one of the three families into which he divides the Nematognathi (= Siluridæ); and, finally, GILL (13) reserves for it one of his eleven families of Nematognathi.

organ encapsuled by bone, but the capsules are perforated posteriorly for the passage of two cæcal diverticula.

*The Homology of the Weberian Ossicles.*

Except with regard to the intercalarium, our investigations throw no additional light on the nature of the Weberian ossicles, and that this is the case is mainly due to the highly specialized character of this mechanism in the Siluridæ. As far as this family is concerned comparative anatomy is of but little use in the discussion of this question, and embryology is the only line of investigation which offers any prospect of a satisfactory and final solution of the problem. The views of different investigators on this point are mainly based on a comparative examination of the condition and relations of the ossicles in the less highly specialized Ostariophyseæ, and principally in the Cyprinidæ. The conclusions of RAMSAY WRIGHT and GRASSI, however, rest on the development of these structures in *Amiurus catus* (Siluridæ) and the Carp (Cyprinidæ) respectively. The different views may be briefly stated in the following table:—

	Clastrum.	Scaphium.	Intercalarium.	Tripus.
BAUDELLOT (1868) . . .	Neural spine, or divided inter-cranial bone of $v.^1$	Neural arch of $v.^1$	Neural arch of $v.^2$	Transverse process or rib of $v.^3$
NUSBAUM (1881) . . .	Neural spine of $v.^1$	" "	" "	Rib of $v.^3$
GRASSI (1882) . . .	Part of the skull	" "	" "	Transverse process of $v.^3$
RAMSAY WRIGHT (1884).	Neural spine of $v.^1$	" "	" "	" "
SAGEMEHL (1885) . . .	Part of the occipital segment of the skull	" "	Rib of $v.^2$ . . .	Rib of $v.^3$
SÖRENSEN (1890) . . .	Neural spine of $v.^1$	" "	Neural arch of $v.^2$	"

( $v.^1, v.^2, v.^3$  = the first, second, and third vertebræ.)

The identification of the intercalarium as the neural arch of the second vertebra rests mainly on its condition and relations in certain Cyprinidæ. In *Cyprinus* the ossicle consists of an articular process which rests on the body of the second vertebra, of an ascending process which forms part of the wall of the neural canal, and a horizontal process terminating distally in the interossicular ligament. In the light of such facts the nature of the intercalarium presents no special difficulty. With the Siluridæ, however, it is otherwise. In all previously investigated species the intercalarium is represented by a variously shaped nodule of bone imbedded in the interossicular ligament, and has no connection with the walls of the neural canal, or with

any vertebral centrum. On this point, RAMSAY WRIGHT (44) remarks, "the Siluroids do not afford the necessary material for determining the homology of the incus\* on account of its reduced condition" (p. 109). The condition of the ossicle in at least some Characinidæ is essentially similar, and this led SAGEMEHL (33) to regard it as a free metamorphosed rib belonging to the second vertebra. We are able to show, however, that the Siluridæ do afford the necessary evidence for determining the nature of the ossicle. Our discovery of an intercalarium in the Siluroids *Macrones*, *Liocassis*, *Pseudobagrus*, &c., which has an ascending process forming part of the wall of the neural canal, and a horizontal process which terminates distally in a nodule imbedded in the interossicular ligament, at once brings the Siluridæ into conformity with the Cyprinidæ, and establishes the identity of the ossicle in the former family. The correctness of this conclusion is confirmed by the fact that the ascending process of the ossicle in these Siluroids is situated between the paired foramina for the exit of the roots of the second and third spinal nerves from the neural canal. The condition of the ossicle, in the majority of Siluroids, is clearly due to degeneration from its more primitive condition in *Macrones*; and from this point of view such genera as *Callichrous* and *Cryptopterus*, in which the ascending process has vanished, and the horizontal process and its distal expansion alone remain, must be regarded as supplying an intermediate stage between the two extremes. A further question arises as to whether, in addition to a modified neural arch, the intercalarium did not originally include an element comparable to a transverse process. We are inclined to think that it did, and that the horizontal process of the ossicle, when present, represents the modified transverse process of the second vertebra. In its origin from the neural arch or ascending process, the horizontal process conforms precisely to the contiguous transverse processes of the fourth and fifth vertebræ, which spring in exactly the same way from the neural arches, and not from the centra of their respective vertebræ.

#### V.—THE PHYSIOLOGY OF THE AIR-BLADDER AND WEBERIAN MECHANISM IN THE SILURIDÆ.

##### A. *Siluridæ normales*.

From the morphology of the air-bladder and Weberian ossicles, we may next proceed to discuss how far the facts elucidated in the preceding sections of this paper throw any light on the vexed question of their physiology.

There is a strong *à priori* probability that the Weberian mechanism is physiologically related to one of the several functions that have been ascribed to the auditory organ or to the air-bladder, but to which of them is a question by no means

\* (= intercalarium.)

easy to answer. A preliminary difficulty to be encountered is the complex physiological character of the two organs; and, apart from our imperfect knowledge of the physiology of the several functions assigned to each, and especially in the case of the internal ear of Fishes, a further difficulty is afforded by the total absence of any experimental evidence directly bearing on the functional significance of the Weberian ossicles. And, while we desire to emphasize the danger of making physiological deductions from facts of a purely anatomical nature, no other course has yet been adopted by previous writers on this subject, and, at present, this is the only one open to us; consequently, any conclusions based upon data so frequently misleading and unreliable must partake rather of the nature of suggestions, and be accepted with considerable reserve. With the qualification rendered necessary by these considerations, some light may possibly be thrown on this difficult problem by a careful inquiry as to how far the Weberian ossicles, and the coadapted parts of the air-bladder and internal ear, are anatomically fitted to act as subsidiary or accessory structures in connection with any of the several functions assigned to either the air-bladder or internal ear, while unsuited for association with others. By this means it may at least be possible to eliminate certain functions from any further consideration, and thereby considerably narrow the scope of future inquiry.

With this object in view, we propose in this section of our paper to discuss (1) how far the function of the Weberian mechanism is conditioned by the anatomical structure of the air-bladder and internal ear; (2) to which of the known functions of the air-bladder and auditory organ the Weberian ossicles are to be regarded as accessory structures; and (3) the use and advantage of the Weberian mechanism to the Fish possessing it.

1. In all the Siluridæ normales the air-bladder may be regarded as consisting of two intercommunicating, but physiologically distinct, portions—a posterior, represented by the two lateral compartments, which is indistensible and inelastic, and always of greater internal capacity; and an anterior, which, on the contrary, is always more or less elastic and expansible, but of less internal capacity than the former. The distensibility of the anterior chamber, however, is by no means uniform in all directions; on the contrary, and for reasons already given,\* this portion of the bladder is absolutely inexpandible, except laterally at right angles to its antero-posterior axis. From the mode in which the fibres forming the lateral walls of this chamber converge in each half of the dorsal wall and become inserted into the convex outer margin of the crescentic process of the tripus, it becomes still further obvious that it is only by inward or outward bulgings of the lateral walls that variations in the internal condition of the air-bladder are able to set in motion the series of Weberian ossicles. It is scarcely necessary to point out that by this restriction of the expansion or contraction of the anterior chamber to movements of its lateral walls, which alone

\* See pp. 93-95, 98, and 239-241.

are directly connected with the tripodes, the Weberian ossicles are rendered more susceptible, and, therefore, capable of responding to smaller variations of internal gaseous tension, by whatever cause produced, than if the anterior chamber were equally elastic and expansible in all directions. The increased delicacy of the Weberian mechanism in the normal Siluridæ, as compared with other Ostariophyseæ, is probably the cause of the more extensive ankylosis of the anterior vertebræ, and their rigid articulation with the skull. If the anterior vertebræ were flexibly articulated with one another and to the skull, so as to be able to participate in the lateral flexion of the vertebral column in ordinary locomotion, while at the same time these vertebræ and their processes retained their close relation to the dorsal surface of the air-bladder, the anterior chamber and Weberian ossicles could hardly fail to be affected by muscular compression. Consequently, the ankylosis of those vertebræ which are specially related to the anterior chamber becomes almost a necessity in the Siluridæ if the Weberian mechanism is to remain unaffected by the more or less violent shocks produced by variations of muscular contraction and relaxation. The posterior portion of the air-bladder, represented by the two lateral compartments, lies free in the abdominal cavity and is not specially related to any skeletal elements, and ankylosis in this region does not, therefore, take place. From the position and shape of the tripus and its mode of articulation with the centrum of the complex vertebra, as well as from the relations and attachments of its crescentic process to the fibres converging from the corresponding lateral wall of the anterior chamber, it will follow that any inward or outward movement of the lateral wall will necessarily cause the crescentic process to move either inwards or outwards, while the anterior process of the same ossicle will execute similar movements, but in inverse order. In all such movements the tripus constitutes a lever of the first order, the fulcrum of which is represented by the articulation of the articular process of the ossicle with the complex centrum. The relative lengths of the two arms of the lever, that is to say, the anterior and crescentic processes, vary somewhat in different Siluroids, although within limits so narrow that in the great majority of the normal forms that came under our notice the two were of approximately equal length. Very exceptionally the anterior process may be slightly the longer of the two, and, consequently, like the long arm of a lever, gains in amplitude of movement what it thereby loses in force. Any inward or outward movement of the anterior process of the tripus will impart either a push or a pull to the interossicular ligament, and finally to the spatulate process of the scaphium, which, therefore, moves either inwards or outwards by a corresponding rotation of that ossicle on its condylar and ascending processes, and with every such movement of the scaphium a forward or backward impulse will be given to the perilymph of the atrial cavities. The characteristic curvature of the crescentic process of the tripus apparently serves no other purpose than that of increasing the surface required for its connection with the fibres of the air-bladder.

The precise mode in which movements of the anterior process of the tripus are

transmitted to the scaphium requires a more critical examination than has yet been given to this point by previous writers. Although of considerable thickness in proportion of its length, the interossicular ligament cannot be regarded as a rigid structure, but rather as being more or less compressible, and hence the immediate result of any slight inward movement of the anterior process of the tripus towards the scaphium, following upon any outward bulging of the corresponding lateral wall of the anterior chamber, will be the compression of the ligament in the direction of the length of its component fibres, and this must necessarily lead to an outward bulging or swelling analogous to that of a contracting muscle, the swelling taking place at right angles to the direction in which the force tending to produce compression is applied. Under such circumstances, no immediate inward movement of the spatulate process of the scaphium takes place. Conversely, any slight outward movement of the tripus that might subsequently take place would at first only have the effect of straightening, as it were, by a pull, the outwardly bulging fibres of the ligament. Hence, it may be concluded that relatively slight incursions or excursions of the anterior process of the tripus will produce no effect on the scaphium, and that only movements of the tripus, of greater amplitude than those now under consideration, are competent to bring about corresponding movements of the scaphium, or affect the fluids of the internal ear. But, apart from the interossicular ligament, there are other reasons for the belief which we certainly entertain, that the Weberian ossicles are but ill-adapted for the transmission of movements caused by the slight inward or outward bulging or vibration of the lateral walls of the anterior chamber. The size of the Weberian ossicles, or at all events, of the tripus; the character of the articulation between the articular process of the tripus and the centrum of the third vertebra, which, in some Siluridæ (*e.g.*, *Auchenipterus nodosus* and *A. obscurus*) is effected by the actual but flexible continuity of that process with the centrum in question; and the fact that all movements of the ossicles, or at least of the tripus, must take place in the loose, fluid-infiltrated connective tissue of the saccus paravertebralis—seem to afford strong additional evidence that the Weberian apparatus is far better adapted to register the more forcible, even if more gradual distensions or contractions of the anterior chamber, rather than slight or rapidly recurring vibrations of its lateral walls. Among other facts tending to the same conclusion may be mentioned the extreme thickness of the walls of the air-bladder in many Siluroids, and in certain genera and species (*Osteogeniosus*, *Ælurichthys*, and several species of *Arius*), this feature is still further emphasized by the development of vertically-disposed, buttress-like, aggregations of the fibres forming the inner stratum of the tunica externa of the lateral walls of the anterior chamber. The peculiarities of the interossicular ligament and the inertia of the Weberian ossicles, taken in conjunction with other anatomical features more directly pertaining to the structure of the air-bladder itself, seems to us to offer an insuperable objection to any theory of the function of those ossicles which relies upon their capacity to be affected by, or to transmit to the internal



ear, vibrations or other movements of the lateral walls of the anterior chamber that are of slight amplitude and rapid recurrence from whatever source derived. In fact, it would almost seem as if the interposition of a lax, or rather compressible ligament between any two of a series of three movable ossicles, were a special contrivance for the express purpose of preventing the internal ear from becoming susceptible to any but the comparatively grosser changes that take place in the internal condition of the air-bladder. It is also difficult to avoid the conclusion that the Weberian ossicles constitute a mechanism which, while not sufficiently delicate to be capable of transmitting to the internal ear slight variations in the condition of the gaseous contents of the air-bladder, is, nevertheless, very susceptible to all such changes that exceed a certain minimum.

The function of the intercalarium is not very clear in those Siluridæ in which it is represented by a mere nodule of bone imbedded in the interossicular ligament, unless it is to impart some slight rigidity to that structure, but even if this be the case the ligament still remains sufficiently lax or compressible to warrant the physiological conclusion to which reference has just been made. In the very limited number of instances (*e.g.*, *Macrones*, *Pseudobagrus*, *Liocassis*, etc.) where the intercalarium not only consists of a horizontal process with its distal end imbedded in the interossicular ligament, but in addition, of an ascending process lying in the fibrous wall of the neural canal between the exoccipital and the arch of the third vertebra, it is also difficult to see that the ossicle can have any other function assigned to it than that of slightly stiffening the ligament in question. Some light, however, may be thrown on this point by a comparison of the position and relations of the intercalarium in the two families of the Siluridæ and Cyprinidæ. In the latter family, where the ossicle is represented by a Y-shaped bone having its two arms articulated with the lateral surface of the conjoined second and third vertebræ, and the distal extremity of its outwardly-directed stem inserted into the centre of the interossicular ligament, the scaphium is somewhat more anterior in position than the anterior extremity of the tripus, and consequently the ligament in passing between the two ossicles, assumes a direction which is somewhat oblique from behind forwards and inwards. Not only is the ligament more oblique in direction, but it is of also greater relative length and thinness than in the Siluridæ. In this case there can be but little doubt that the intercalarium functions as a pulley, and by moving through the arc of a small circle coincidently with the motion of the tripus, so alters the direction of the pull of the interossicular ligament as to enable the latter more directly to exert its full force on the scaphium. In the absence of an intercalarium, or if that ossicle were in the same condition as it is in the great majority of the Siluridæ, the length, thinness, and compressibility of the ligament would be such that it is difficult to see how any but the most extensive volumetric variations of the air-bladder could possibly have any effect either on the scaphium or the internal ear. In the Siluridæ, on the contrary, the spatulate process of the scaphium is situated

exactly opposite and internal to the anterior extremity of the tripus, and hence the transversely-disposed interossicular ligament passes straight from one ossicle to the other, and no sesamoid or pulley-like action of the intercalarium is necessary. We are, therefore, inclined to regard the intercalarium in the Cyprinidæ as fulfilling its primary function of giving increased leverage to the action of the interossicular ligament, such a function being necessitated by the relative positions of the two ossicles between which this ligament extends; while in the Siluridæ, on the other hand, from the altered relation and more direct juxtaposition of the scaphium and tripus, the need of an intercalarium is no longer felt; and consequently this ossicle in the vast majority of the normal Siluridæ becomes the comparatively functionless vestige of a physiologically more important structure in the Cyprinidæ. At all events this conclusion seems to receive considerable support from the fact that the difference in the relative positions of the scaphium and tripus seems to be a constant character in all hitherto investigated species of the two families, and correlated with such differences there are also certain almost equally constant modifications in the condition of the intercalarium, to the extent that in nearly all Siluridæ the ossicle has lost all connection with its vertebral centrum, and becomes but a comparatively insignificant nodule in the interossicular ligament, whereas in all the Cyprinoid Fishes, including even those with abnormal air-bladders, the intercalarium retains both its insertion into the ligament as well as its fulcral connection with the centrum of the second vertebra.

The function of the radial fibres of the tripus seems to be that of antagonizing the outward pull which those fibres that pass from the convex side of the same process into the dorsal and lateral walls of the anterior chamber exert upon the tripus during any lateral distension of that part of the air-bladder. When distension subsides the pull of the previously tensely stretched radial fibres causes the crescentic process to move inwards to its normal position of close relation to the lateral surface of the complex centrum. Normally the two sets of fibres exactly counterbalance each other, and according as the volume of the anterior chamber is increased or diminished by lateral expansion or contraction, so will the pull of one set of fibres predominate over that of the other. In one or two instances (*e.g.*, *Auchenipterus*) where the elasticity of the articular process of the tripus functionally replaces the radial fibres, the latter are but feebly developed.

Any push or pull given to the spatulate process of the scaphium by the inward or outward movement of the anterior process of the tripus must also cause the former to move inwards or outwards, and by so doing slightly decrease or increase the size of the atrial cavities. The immediate effect of this will be to cause either a forward or a backward flow of the fluids of the two cavities. The extent to which the atrial cavities will be increased or diminished in size by these means will, of course, primarily depend upon the amount of lateral contraction or distension to which the anterior chamber of the air-bladder is liable, but the result will be that any motion, whether

actual or molecular, imparted to the fluid contained in those cavities must be transmitted to the endolymph of the sinus and ductus endolymphaticus, and eventually to that which fills the two sacculi, and finally act as a stimulus to the sensory epithelium of the latter. RAMSAY WRIGHT has briefly discussed the influence exerted by the movements of the scaphia on the fluids of the membranous labyrinth, and with his conclusions we entirely agree. With every inward movement of the spatulate process of the scaphium "the cavity of the atrium sinus imparis is diminished, and the contained fluid urged onward. As the result of more fluid being forced into the cavum sinus imparis the saccus endolymphaticus, which floats freely in it, must be compressed and a current of endolymph urged forwards which must impinge very directly on the macula acustica sacculi of each side. The position of the maculæ with relation to the saccus and ductus endolymphaticus would appear to render unnecessary the special maculæ described by NUSBAUM (29) in *Cyprinus*. In any case the altered tension in the anterior part of the air-bladder will be brought within range of perception by the auditory nerve" (43, p. 383). If any doubt attaches to these statements it is whether the saccus endolymphaticus undergoes actual compression, or that as a consequence an actual flow of endolymph takes place towards the sacculi. It may more probably be the case that movements of the two scaphia produce oscillation waves in the fluids of the atrial cavities and the cavum, and that such waves cause similar disturbances in the endolymph of the saccus and ductus endolymphaticus, but without there being any actual flow towards the sacculi. There can be but little doubt that the sensory epithelium of the two sacculi is solely concerned in the transmission of stimuli received through the Weberian mechanism to the auditory nerve, for the oblique valve in the ductus sacculo-utricularis must prevent the extension of any disturbance in the endolymph of the sacculi to the utriculi, or to the semi-circular canals and their ampullæ.

HASSE'S suggestion (18) that the propulsion of fluid into the atrial cavities and the cavum sinus imparis may, by radiation of pressure, directly stimulate either the spinal cord or the base of the brain, has been successfully opposed by RAMSAY WRIGHT, who expresses his belief "that it is solely through the auditory nerve, and especially through its saccular branches, that the central nervous system is informed of the movements of the 'malleus' and 'stapes,' and consequently the state of distension of the air-bladder" (*loc. cit.*, p. 384).

The peculiar sac (receptaculum dorsale) which in *Amiurus catus* lies on the dorsal side of the medulla oblongata, and ends blindly behind in two lobes but anteriorly communicates with each atrium at the point where the latter becomes continuous with the cavum sinus imparis may, as RAMSAY WRIGHT (*loc. cit.*, p. 384) not unreasonably suggests, act as a reservoir for the fluids of the atrial cavities, or may serve to receive any excess driven out of the atria by the movements of the scaphia, and therefore prevent shocks of undue force from being imparted to the endolymph of the saccus endolymphaticus, and eventually to the nerve endings of the maculæ acusticæ of the

sacculi. A similar function may possibly be assigned to the receptaculum dorsale described by us in *Macrones nemurus*.\*

No differential action of the two sacculi can possibly take place, at all events so far as impulses received through the Weberian mechanism are concerned, since the only channel through which any movement initiated in the fluids of the atrial cavities by the motion of the Weberian ossicles can reach them is the median and unpaired sinus endolymphaticus; hence it must follow that each sacculus will be affected by any such disturbances to an equal extent and at the same moment.

It may be well to emphasize the fact that, whatever may be the force which sets the Weberian ossicles in motion, there are no obvious adaptations for increasing its intensity in the course of transmission to the sensory epithelium of the inner ear, and if, as we believe will prove to be the case, it is the variations in the volume of the gas contained in the air-bladder under the influence of different hydrostatic pressures, which condition the lateral expansion or contraction of the anterior chamber, it is obvious that the force exerted on the Weberian ossicles will be too considerable for there to be any use of increased leverage in order to augment the impulse imparted to the fluids of the internal ear. We shall again refer to this point in discussing WEBER'S auditory theory of the function of these ossicles.

On the whole, and apart from any predisposition in favour of any particular theory, the impression left upon our minds by a consideration of the extent to which the physiology of the Weberian mechanism is conditioned by the more obvious features in its structure and relations to the air-bladder is, that it is not adapted for the transmission of the smaller changes of whatever nature that may take place in the condition of the gaseous contents of the air-bladder; still less is the mechanism adapted for the transmission of any rapid vibratory impulses that may be communicated to the contained gases; on the contrary, the mechanism would seem to be admirably fitted to acquaint the Fish with the occurrence of the grosser volumetric variations that from time to time may affect the entire gaseous contents of the air-bladder.

2. The second point for consideration is—to which of the several known functions of the air-bladder and internal ear are the Weberian ossicles to be regarded as accessory structures.

As we have already pointed out, an initial difficulty in the way of any attempt to solve this question is the complex physiological character of the two organs which the Weberian ossicles bring into functional relations. At least two distinct functions must be considered in connection with the auditory organ, (1) audition, and (2) equilibration, or orientation;† while the air-bladder in different Fishes is even more complex in function, more so possibly than any other organ. Among the various uses

\* See p. 81.

† As a sequel to the researches of GOLTZ and others among Vertebrata, mention may be made of the fact that DELAGE (11) and ENGELMANN (12) have shown that it is highly probable that the so-called

attributed to the air-bladder by different writers may be mentioned (1) phonation; (2) respiration; (3) an accessory to audition; or (4) its function may be purely hydrostatic.

Certain of these functions can at once be eliminated from any discussion as to the physiological significance of the Weberian ossicles.

Equilibration is one of these. No conceivable changes are likely to take place in the condition of the gaseous contents of the air-bladder as the result of any movement of rotation or oscillation on the part of the Fish, and without such changes of a degree and kind calculated to produce movements of the lateral walls of the anterior chamber, no motion of the Weberian ossicles could take place, neither would any change occur in the endolymph of the semicircular canals, either in the form of intralabyrinthic pressure, as GOLTZ himself proposed, or by an actual flow, as maintained by MACH, BREUR, and CRUM-BROWN. But even supposing that movements of oscillation or rotation were competent to so alter the internal condition of the air-bladder that increased pressure or a flow would be produced in the fluids of the atrial cavities, and secondarily, in the sinus and ductus endolymphaticus and the two sacculi, the presence of an oblique valve in the ductus sacculi-utricularis would certainly tend to hamper, even if it did not entirely prevent, the extension of such disturbances into the semicircular canals, where the function of equilibration is specially located. And, finally, it may be mentioned that even if no other difficulty existed, the fact that no differential action of the two membranous labyrinths could take place as the result of stimuli received from the air-bladder through the Weberian ossicles, must be fatal to the existence of any functional relations between equilibration and the Weberian mechanism.

In addition to the various other methods by which voluntary sounds are produced in different Fishes, the air-bladder not infrequently shares in the function of phonation. Such sounds are either produced by the vibration of the internal annular diaphragm,\* or by the vibration of certain extrinsic muscles,† the air-bladder in the latter case intensifying the sound produced by acting as a resonator. DUFOSSÉ (*loc. cit.*) is also of opinion that some Ostariophyseæ (*e.g.*, some Cyprinidæ and one or two Siluridæ) produce breathing noises ("les bruits de souffle") by the expulsion of gas from the air-bladder through the ductus pneumaticus, and it has been suggested that the grunting sounds emitted by *Clarias*‡ have a similar origin.

The possibility that the Weberian ossicles have anything whatever to do with phonation, either in the Siluridæ, or in other Ostariophyseæ, is very remote and need be but briefly considered.

auditory organs of many aquatic Invertebrata may perform singly or conjointly the functions of equilibration and audition.

\* MOREAU (27A).

† DUFOSSÉ (11B).

‡ Quoted by DAY in "Instincts and Emotions in Fish," 'Linn. Soc. Trans.' (*Zool.*), vol. 15, 1880.

It is by no means obvious that DUFOSSÉ is correct in regarding all these examples of breathing noises as genuine instances of the production of voluntary sounds, still less is it clear that the emission of such sounds is in any way a part of the normal function of the air-bladder. In none of the Siluridæ or Cyprinidæ that DUFOSSÉ mentions is there any mechanism by which the expulsion of gas from the air-bladder through the ductus pneumaticus in sufficient volume or with sufficient rapidity to produce audible sounds could be effected. Any such expulsion of gas seems only to take place under the influence of a diminution in the pressure of the superincumbent water, in which case the expansion of the gas might lead to its forcible escape from the air-bladder and at the same time to the emission of a breathing noise. This certainly does occur in many Physostomi, and may be utilized by the Fish as a means of adjusting the volume of its air-bladder and the specific gravity of its body to varying external pressures, but there is certainly no clear evidence that this method is ever employed in the production of normal *voluntary* sounds in the Ostariophyseæ, and even if it were the case the effect could only be produced at the expense of a considerable disturbance both of the normal equilibrium of the Fish in the water and of its locomotor activity. We are strongly inclined to the opinion that although sounds may indirectly have their origin in the air-bladder, they have no relation to it other than as accidental accompaniments in the exercise of its normal hydrostatic function.\* In one example cited above (*Clarias*) it is almost certain that the grunting sound which the Fish is said to make could not be caused by the voluntary expulsion of gas from the air-bladder, inasmuch as this organ is not only rudimentary but almost completely encapsuled by bone. Eliminating such doubtful examples of the association of the air-bladder with phonation in a few Siluridæ and Cyprinidæ, it may be urged with regard to the rest that the comparative rarity of well authenticated instances of the production of voluntary sounds, the absence of extrinsic muscles in all but a few genera (Pimelodinæ), and the want of internal vibratory diaphragms, or other obviously vocal structures, are quite sufficient to prove that the air-bladder takes little or no part in this function, at all events, by any of the ordinary methods known in other Fishes. This conclusion seems to us to apply not only to the two families referred to above, but to all other Ostariophyseæ about which reliable information can be obtained, and to warrant the exclusion of phonation from further consideration in connection with the Weberian mechanism.

With regard to respiration the air-bladder in different Fishes is said to be related to this function in one of two ways, acting either as a lung subsidiary to the gills, or as an oxygen reservoir.

There is no satisfactory evidence that respiration can be effected by the transit of

\* For these reasons, and in the absence of definite experimental evidence, we cannot at present accept SÖRENSEN'S ingenious theory that the extrinsic muscles of the air-bladder in the Pimelodinæ and the "elastic-spring" apparatus of other Siluridæ are solely subordinate to the voluntary production of sounds.

air to and from the air-bladder through the ductus pneumaticus in any Physostomi. Many Fishes frequently resort to the surface and swallow air, which may either act directly on the gills, or on accessory respiratory organs, but the somewhat prevalent impression that some Physostomi are capable of inhaling air through the pneumatic duct rests upon no satisfactory foundation and may be dismissed from consideration.\*

On the other hand, there is a large body of experimental evidence for the belief that the air-bladder has an important, though secondary, relation to respiration by acting as a reservoir for the superabundance of oxygen which is taken into the blood through the gills, and subsequently re-absorbed from the air-bladder into the blood when the Fish is in water containing but little of that gas in solution.† It seems clear, nevertheless, that, however important this secondary relation of the air-bladder to respiration may be in Fishes in general, there can be no physiological connection between it and the Weberian mechanism. The function of the air-bladder as an oxygen reservoir is, to say the least, as characteristic of those Fishes in which a Weberian mechanism is absent, as it is of those in which it is present. In fact, MOREAU'S researches go much further than this, and prove to the point of actual demonstration that of the Fishes with which he experimented those provided with a Weberian mechanism had relatively but little capacity for absorbing oxygen from the air-bladder, when placed under conditions likely to cause asphyxia, *i.e.*, in water deprived of its oxygen, whereas many other Fishes belonging both to the Physoclist and Physostome divisions of the Teleostei, in which the Weberian apparatus is wanting, had a far greater capacity for absorbing oxygen under similar conditions than the former. MOREAU has also shown that a marked capacity for oxygen absorption is always associated with the presence of retia mirabilia in the walls of the air-bladder, and these structures, as we have already pointed out, are invariably absent in all Siluridæ, and, so far as we are acquainted, in all the remaining Ostariophyseæ.

Dismissing respiration, we may next consider the much more difficult and debatable question whether these structures can be regarded as in any way subsidiary to the function of audition.

Our knowledge of the physiology of hearing is mainly confined to the higher air-breathing Vertebrata, and but comparatively little is experimentally or certainly known at present about this function in Fishes. The conditions of subaqueous audition are in several respects very different from those in air. Not only do sound vibrations in water travel with more than quadruple the rapidity with which they are transmitted in air, but they can be appreciated at far greater distances. There is, in fact, a closer analogy between water and solid bodies than between water and air, so far as the transmission of sound vibrations is concerned. These facts may, to some extent perhaps, be physiologically illustrated by the statement that the relations of the auditory organ of a Fish to a sounding body in water are not very dissimilar to

\* JOBERT'S experiments (20) to the contrary are, in our own opinion, not conclusive.

† See MILNE-EDWARDS (25), and GOURIET (13A).

those of an air-breathing Vertebrate when its skull is directly connected with the source of sound. That this is to some extent true is borne out by experiment. In making their celebrated experiments on the transmission of sound in the water of Lake Geneva, COLLADON and STURM\* found that sound vibrations, too feeble to produce any appreciable effect on the external surface of the skull when they passed through air could, nevertheless, strongly impress the ear when they were propagated in water and the head of the observer was completely immersed in the fluid. (2.) The same observers also remarked that while the vibrations passed with difficulty from water to air the converse was also true. For Fishes in general, therefore, we are unable to see that there is any need to assume, in the absence of any experimental proof to the contrary, that the essential conditions of subaqueous audition are very different from those in air, except in so far as the physical differences in the conductivities of the respective media are concerned. Sound waves produced by any sounding body in the water and impinging upon the surface of the Fish's skull will readily be transmitted to the internal ear, and such sounds will in all probability be heard with greater rapidity and from greater distances than could possibly be the case under similar conditions in air. In the special case of those Fishes with a Weberian mechanism the question becomes much more complicated, and in dealing with it we shall confine ourselves to the Siluridæ more particularly, although, with slight and unimportant modifications, the same line of argument will be applicable to all other Ostariophyseæ.

WEBER himself not only regarded the ossicles which bear his name as homologous with the incus, malleus, and stapes of the Mammalian ear, but attributed to them an almost exactly similar function. He imagined that sound waves impinging on the surface of the body ultimately affected the air contained within the air-bladder, which organ then acted as a resonator, and by means of the Weberian ossicles transmitted the vibrations to the internal ear. Presumably, the only way in which sound waves can affect the Weberian ossicles and internal ear is by traversing the body wall of the animal and throwing into vibration the air in the air-bladder, which in turn may be conceived as impinging upon the only portions of the bladder at all likely to be capable of vibratory motion, viz., the lateral walls of the anterior chamber; the vibration of these walls might initiate corresponding vibrations in the series of ossicles considered as a rigid whole, and such vibrations through the movements of the scaphia may be supposed to affect the perilymph of the atrial cavities, and eventually the endolymph of the internal ear itself. If WEBER's theory be true the air-bladder must necessarily become an important accessory to audition in all Fishes in which this peculiar mechanism is present. In ordinary Fishes the only sound waves capable of acting as stimuli to the auditory nerves will be those that fall directly on the skull, but in those that possess WEBER's ossicles sound waves impinging on the general surface of the body may, through the air-bladder, become convertible into auditory stimuli.

\* "Mémoire sur la compression des liquides," 'Mém. de l'Académie des Sciences,' vol. 5, p. 346.



From the date of the publication of WEBER'S memoir until the appearance of HASSE'S paper (18) in 1873, the majority of writers on this subject have more or less explicitly accepted WEBER'S views with but little or no qualification, and the term "auditory," as applied to the ossicles, still lingers as an interesting survival of the notion which he entertained of their function. But in addition to those who, like WEBER, apparently regard the Weberian ossicles as related solely to audition, there are others who, while assigning a very different primary function to those structures, are not altogether prepared entirely to exclude the possibility that they may still be, in some subordinate degree, accessory to the function of hearing, and among such writers must be included HASSE—the first opponent of WEBER'S theory—and RAMSAY WRIGHT.

Apart from the *a priori* probability that the existence of an anatomical connection between the air-bladder and the internal ear, is to render the former a physiological accessory to audition, and the apparent analogy between the Weberian ossicles and the auditory ossicles of the higher Vertebrata, there is but little to be said in favour of WEBER'S view, and even this argument may be used in quite another way and with equal force, for it is at least as likely that the Weberian ossicles are related to some function of the air-bladder as that they are subsidiary to any function of the internal ear. On the other hand, there are many and weighty reasons for the belief that WEBER'S theory is absolutely untenable, and of these we may direct attention to the following :—

(1.) The imperfections of the air-bladder and the Weberian mechanism considered as structures accessory to audition. The gravest objections to the theory certainly come under this head. It may be objected—

(a.) That sound vibrations pass with great difficulty from water to air, and hence, if such vibrations are to pass at all from the external medium to the gases contained within the air-bladder, the transmission must be accompanied by a considerable loss of intensity, and the effect upon the latter can be but slight. The intervention of a solid medium between the external surface of the body and the fluids of the internal ear, such as may be found in the bones of the skull, would afford a far better channel for sound conduction than a membranous air-containing sac.\* Moreover, although this objection does not apply to the Siluridæ with lateral cutaneous areas, the sound waves in passing from the exterior to the gases of the air-bladder must be greatly retarded in most Ostariophyseæ by having to traverse, not only the lateral muscles of the body wall, but also the air and fluid infiltrated spaces or organs of varying densities by which the bladder is surrounded.

(b.) Assuming, in spite of this difficulty, that the air in the air-bladder can be thrown into vibration, it may yet be objected that in many Siluridæ the walls of that

\* The minute size of the external auditory meatus in some aquatic mammalia (Cetacea) suggests that even in these animals the sound waves, which are effective as auditory stimuli, must traverse the cranial bones.

organ are too thick to admit of their vibrating synchronously with rapidly recurring sound waves. This objection may certainly be emphasized in those instances in which the walls of the air-bladder are specially thickened where alone their vibration can be conceived as likely to produce corresponding movements in the Weberian ossicles, viz., the lateral walls of the anterior chamber. And, moreover, in the case of all the remaining families of Ostariophyseæ, where the anterior chamber is not specially damped in particular regions through contiguity with suitably modified portions of the skeleton, its walls would probably vibrate to an equal extent in all directions, but, as only those vibrations which affect the lateral walls, or take place transversely, are competent to impart their motion to the Weberian ossicles, there must, in such cases, be a considerable loss in the intensity of the final effect produced on the internal ear; and, hence, in dealing with the question of the fitness of the walls of the bladder to be affected by, or to transmit to the Weberian ossicles, delicate wave impulses in the contained gases, we cannot but regard this objection as a serious one.

(c.) It may be further objected that the Weberian ossicles do not satisfy the necessary conditions required in a series of movably articulated ossicles adapted for the transmission of sound vibrations by vibrating as a rigid whole. In the, in some respects, analogous mechanism of the Mammalian tympanum the auditory ossicles directly articulate with one another without being in any way separated by a fibrous ligament of any description, and hence the ossicles are capable of vibrating as a rigid whole, synchronously with the sound vibrations that impinge on the tympanic membrane, and also of communicating such vibrations to the fluids of the inner ear. The Weberian ossicles, on the contrary, are but ill adapted for any such function. As we have previously pointed out, the inertia of the ossicles themselves, the mode of articulation of the tripodes with the centrum of the complex vertebra, which in some cases is affected by the actual continuity of their articular processes with the centrum in question, and more especially the interposition of a lax, or at all events compressible, ligament in the series of ossicles, are insuperable objections to any theory that requires that these structures should vibrate as a rigid whole, by rapidly recurring movements of slight amplitude, synchronously with the sound waves which, *ex hypothesi*, are produced in the gases of the air-bladder.\*

There are also other features in which the Weberian and true auditory ossicles may be compared and contrasted. With auditory ossicles there are almost always certain anatomical adaptations by means of which the effect produced at one end of the series by the direct impact of sound waves is considerably intensified at the other, where the ossicles are in direct relation with the fluids of the internal ear. This effect is usually brought about by the existence of marked disparity in the superficial areas of the tympanic membrane and the membrane of the fenestra ovalis, and, in addition in Mammalia, by the leverage of the ossicles themselves. In one respect the Weberian mechanism may be said to resemble auditory ossicles. The superficial

\* See also pp. 264, 265

areas of the lateral halves of the anterior chamber of the air-bladder in the Siluridæ vastly exceed the areas of the external atrial apertures, and of the spatulate processes of the Scaphia which close them, and therefore, whatever may be the mode of motion or vibration of the former, the intensity of the final effect upon the latter must be increased in direct proportion to the difference between their respective superficial areas. Nevertheless, it is doubtful if any physiological significance can be attached to this resemblance which, after all, is merely superficial, and, as we have already suggested, is apparently conditioned by the necessarily large relative size of the air-bladder. On the other hand, the leverage of the Weberian ossicles in the Siluridæ is very different from that of the Mammalian auditory ossicles. The approximate equality in the length of the two arms of the lever in the former case is sufficient to prove that no increased effect is gained in the transmission of any form of motion from the walls of the air-bladder to the auditory organ. In fact, so far from there being any special adaptations in the Weberian mechanism for this purpose, which would certainly seem to be necessary in the case of sound transmission, the facts of structure point quite in the opposite direction. The nature of the ligamentous connection between the different ossicles, and the fact that the movements of the Scaphia must take place in a plane at right angles to the posterior entrance of the cavum sinus imparis,\* and the division of the neck of the sinus endolymphaticus into the right and left halves of the ductus endolymphaticus at right angles to the former, seem better adapted to diminish rather than intensify the effect produced on the auditory organ by *slight* vibrations or other movements of the walls of the air-bladder.

(d.) HASSE (18), in opposing the application of WEBER'S theory to the Cyprinidæ, lays some stress on the objection that the perilymph of the atrial cavities and cavum sinus imparis is contained within the interspaces of a reticular connective tissue, and therefore is ill adapted to transmit vibrations to the endolymph of the sinus endolymphaticus. This objection has considerable force when applied to the Cyprinidæ, and possibly also to many other Ostariophyseæ, but is of little moment so far as the Siluridæ are concerned. On this point we quite agree with RAMSAY WRIGHT'S remarks on the Siluroid *Amiurus catus*, which are in complete agreement with our own observations on *Macrones nemurus*. He says, "but in *Amiurus* the fluid in the atrium and cavum is not imbedded in the meshes of the reticular tissue, the wall of the saccus endolymphaticus is so thin that any motion in the surrounding fluid must disturb its contents, and the currents so produced must certainly affect the neuro-epithelium as much, if not far more than the currents produced by sound waves" (43, p. 385). Although this statement to some extent mitigates the force of HASSE'S objection in the case of one particular family, yet in all other cases the objection is a forcible one, and the exceptional condition of the Siluridæ in no way lessens the

\* HASSE (18) directs attention to this point.

strength of the arguments against WEBER'S theory which we have previously urged, and cannot but regard as fatal to it.

(e.) Even if the admission be made that the air-bladder and its ossicles are accessory to hearing, the Fish could have no power of appreciating the direction of sounds conveyed to the internal ear by such means. Any cognizance of the varying directions from which sounds may come is generally believed to be due in all vertebrated animals to the differential action of the two ears, but we have already shown\* that no such action can possibly take place in response to impulses received through the Weberian mechanism in accordance with WEBER'S theory. It would, therefore, seem that any increased acuteness of hearing that might be conferred on the Fish by the air-bladder in its presumptive function as an accessory to audition, would be counterbalanced by the fact that such increase of auditory capacity could not be associated with a corresponding increase in the power of appreciating the direction of sounds. Whatever may be the physiological importance of the sense of hearing in Fishes, whether associated with the pursuit of prey, or as an aid in escaping from enemies, or, as in the case of gregarious Fishes, as a means of keeping together in shoals for breeding or other purposes, the power of appreciating the direction of sounds must be of primary importance in any modification of the auditory organ in the direction of giving to its possessor exceptional powers of hearing.

(2.) Contrary to what might fairly be expected if so complicated a structure as the Weberian mechanism is an accessory to hearing, there is absolutely no evidence of the existence of exceptional powers of hearing either in the Siluridæ or any other Ostariophyseæ.

(3.) Finally, it may be affirmed that there is an alternative view of the function of the Weberian ossicles, which is in perfect harmony with the facts of structure, and is open to none of the objections which can be reasonably urged against WEBER'S theory, and also, at the same time, has an important bearing on the locomotor activities of the Fishes concerned.

With the reservation which the entire absence of direct experimental evidence renders absolutely necessary, it may be affirmed that the arguments set forth in the preceding paragraphs are distinctly adverse to the theory that the Weberian ossicles are in any way related to the function of audition, even to the subordinate and qualified extent tacitly suggested by HASSE and RAMSAY WRIGHT; and the solution of this difficult problem must be looked for in some other direction.

Dismissing sound production, equilibration or orientation, respiration and audition from all physiological connection with the Weberian ossicles, we may now consider the sole remaining alternative view—that the ossicles are accessory to the hydrostatic function of the air-bladder. But before dealing with this aspect of the problem it will be advisable to state what is actually and experimentally known as to the hydrostatic function of the air-bladder in Fishes in general.

\* See p. 268.

One of the earliest theories of the hydrostatic function of the air-bladder with which we are acquainted is that propounded by BORELLI in 1685. According to his theory the function of the air-bladder, in its mean condition, is to render the specific gravity of the Fish equal to that of the water in which it lives, and also aid the Fish in its movements of ascent and descent in the water, such movements being due either to an increase in the specific gravity of the animal as the result of muscular compression of the air-bladder, or to the diminished specific gravity which would result from muscular relaxation and the consequent expansion of the contained gases.\* From the time of BORELLI until the publication of the results of MOREAU'S experimental researches in 1876, the function of the air-bladder proved a fruitful source of discussion among zoologists and comparative physiologists, among whom the names of DELAROCHE, CUVIER, STANNIUS, GOURIET, OWEN, BIOT, MONNOYER, and JOHANNES MÜLLER may be mentioned. Most of these writers, however, adopted the theory of BORELLI with scarcely any modification, and with a like absence of any attempt at experimental proof.

JOHANNES MÜLLER (28), while accepting BORELLI'S views for Fishes in general, is responsible for another theory as to the hydrostatic function of the air-bladder in certain Fishes, which has been widely quoted with tacit approval, but like BORELLI'S theory, has never received the sanction of experimental proof. MÜLLER'S theory is: that those Fishes (Cyprinidæ and Characinidæ) in which the air-bladder is partially constricted into an anterior and a posterior sac, possess the power by muscular contraction of driving the air from one chamber to the other, and thus producing a displacement of the centre of gravity with reference to the longitudinal axis of the animal. By this means such Fishes were supposed by MÜLLER to be able by see-saw movements to vary in a vertical direction the long axis of the body, the fins then causing the Fish to advance in the new direction which the axis of its body had taken.†

More recently the theories of BORELLI and JOHANNES MÜLLER have been successfully opposed on experimental grounds, first, by MOREAU (27), in 1876, and, secondly, by CHARBONNEL-SALLE (6), in 1887. Summarizing the conclusions which these researches appear to justify, it may be affirmed for Fishes in general:—

(1.) That the function of the air-bladder is to render the Fish, bulk for bulk, of the same weight as the medium in which it lives.‡ In this mean condition, or plane of

\* It is worthy of notice that the theory usually associated with the name of BORELLI is practically identical with one propounded by the authors of two papers in the 'Phil. Trans.' for 1675, and therefore published several years earlier than the former. See "Conjecture concerning the Bladders of Air found in certain Fishes," and illustrated by an experiment suggested by the Hon. ROBERT BOYLE; and also "On the Swimming Bladders in Fishes," by Mr. RAY (*loc. cit.*).

† MONNOYER (26) on purely theoretical grounds also adopted MÜLLER'S theory, but admits his inability to support his conclusions by any experimental evidence.

‡ The experiments of DELAROCHE (11A) prove that a Fish without an air-bladder has a density always

least effort, the Fishes acquire a capacity for the maximum amount of locomotion with a minimum of muscular effort.\*

(2.) In its movements of ascent and descent the Fish becomes exposed to augmented or diminished pressure, which in each case varies in amount according to the variable height of the superimposed column of water, and this leads to an expansion or contraction of the air in the air-bladder, and consequently to an increase or diminution in the volume of the Fish itself, and thereby to a corresponding alteration in its specific gravity, which may temporarily remove the animal from its normal plane of least effort.

(3.) The Fish has no power of varying the capacity of its air-bladder by direct muscular contraction, and its re-adjustment to a new plane of least effort results from a gradual increase or decrease in the amount and volume of the contained air to an extent proportional to the new pressure, and due to a corresponding modification of the processes concerned in the secretion or absorption of gas into or from the air-bladder. Hence, by this apparently automatic method of adjustment the Fish will find, sooner or later, and whatever the depth of the water and the amount of external hydrostatic and atmospheric pressure, a plane of least effort where it will again possess exactly the density of the water.

(4.) That JOHANNES MÜLLER'S theory of the displacement of the centre of gravity upon a longitudinal axis in the case of Fishes with a two-chambered air-bladder has no foundation in fact.

The conclusions embodied in the preceding sections relate more particularly to the Physoclisti—by far the largest group of Teleostean Fishes—but it may be pointed out that in a general way they apply also to the Physostomi with, however, the qualification that in the great majority of the latter group the mechanical liberation of gas through the ductus pneumaticus takes the place of absorption as a means of adjustment to reduced pressures.

Although an air-bladder is unquestionably an advantage to the generality of Teleostean Fishes, there can be no doubt that its presence is also attended by certain disadvantages which to a greater or less extent limit and control the locomotor activities of its possessor, and that of these the most important is the restriction of freedom of locomotion in the vertical direction, and the consequent limitation of ordinary locomotion within more or less well defined limits above or below a tolerably constant mean position. As MOREAU says, when a Fish is in a plane of least effort the possession of an air-bladder is a distinct advantage, but for rapid changes of level, as in movements of ascent or descent, the air-bladder may prove a considerable disadvantage or even a source of danger. In a Fish, he remarks, which is exposed to artificially diminished pressure the air contained in the air-bladder will

greater than that of the water, and consequently is never in equilibrium, but must constantly use its fins to prevent itself from sinking.

\* A Fish in equipoise in the water resembles the philosophical toy known as the "Carthusian Diver," and the slightest exertion of its fins will readily cause motion in the vertical direction.

tend to assume and retain an augmented volume, and so lessen the specific gravity of the animal that it rises to the surface and can only rest with part of its body in the air. A Fish, MOREAU adds, incurs more danger by rising above its plane of equilibrium than by sinking below this plane for the same vertical distance. On this point reference may be made to SEMPER's remarks (34, p. 340) on the behaviour of the "Kilch" (*Coregonus hiemalis*) when caught in nets and drawn to the surface.\* A further proof of MOREAU's conclusions is also afforded by the appearance of certain Fishes when forcibly drawn up or carried to the surface from great depths, or even when trawled from quite moderate depths, both the air-bladder and body being greatly distended, the former not unfrequently ruptured, while there is often a prolapsus from the mouth or anus of the contiguous portions of the alimentary canal. It is perhaps not unreasonable to suppose that a Fish, while under normal conditions and free in the water, is liable to accidents similar in kind if less in degree to those caused artificially by experiment whenever it ventured upon rapid vertical movements in the direction of ascent, accompanied by a marked reduction of pressure. The restriction of the vertical range of the Fish is clearly due to the slowness with which the necessary secretion or absorption of gas takes place, and the facts above quoted are in complete agreement with MOREAU's experiments, from which it would appear that the adjustment of the volume of gas in the air-bladder to varying pressures is a comparatively slow process, the length of which, however, varies greatly in different Fishes, and under different conditions in the same Fish. In vertical movements, whether slow or rapid, as long as they are confined within certain limits, the action of the fins may prove a sufficient safeguard against the evil results of a too great or a too low specific gravity, but in more extensive movements, more particularly of ascent, the controlling action of the fins may be utterly inadequate to prevent the Fish incurring considerable danger in the way suggested above. Hence, it may be concluded that in the generality of Teleostean Fishes, and more particularly in the Physoclisti, the possession of an air-bladder tends to greatly restrict freedom of locomotion in the vertical direction.

From the conclusions established by MOREAU and CHARBONNEL-SALLE, it becomes obvious that the varying degrees of tension of the gaseous contents of the air-bladder due to variations in the height of the superincumbent column of water, constitute an important factor in the physiology of locomotion in Fishes, and hence, in the absence of any other tenable hypothesis as to its function, there is a strong *a priori* probability that the object of the Weberian mechanism is to acquaint the Fish with the varying degrees of tension to which the air-bladder may be subjected. HASSE (18), who was the first to oppose the then prevalent idea of the air-bladder and Weberian ossicles in the Ostariophyseæ being accessory to audition, without, however, entirely excluding the possibility that such might be the case in some subordinate degree, was also the first to suggest that the object of the mechanism was to acquaint the Fish

\* See also on the same subject R. OWEN (30, p. 496).

with the varying tensions of the gases contained in the air-bladder. It is clear, however, that the Fish is not only exposed to varying hydrostatic pressures according to the depth at which it lives, but, at the same time also, to similar variations of atmospheric pressure. According to HASSE's view it is the perception of hydrostatic pressure variations with which the Weberian mechanism is more directly concerned. The late Dr. SAGEMEHL (33) also adopted HASSE's theory, at least so far as to regard the Weberian apparatus as constituting a register of pressure variations, but with this important modification, that it is not hydrostatic but atmospheric pressure which the Fish is thereby enabled to appreciate. Postponing for the present any further reference to HASSE's theory, it becomes necessary to ascertain what measure of truth there may be in SAGEMEHL's barometrical theory, more especially as it has not hitherto been the subject of any critical examination.

Apart from certain anatomical features in the structure of the air-bladder in the Siluridæ on which he lays considerable stress, but which are equally reconcilable with HASSE's views, the only special reason advanced by SAGEMEHL in support of his barometrical theory is that most of the Ostariophyseæ, and especially the Siluridæ, live at the bottom of the water, and hence an air-bladder as a hydrostatic organ is of very little value to them. We must confess that we fail to see that the arguments with which he supports his ingenious theory are conclusive or even weighty, and in opposition it may be urged : —

(1.) That the majority of the Ostariophyseæ are certainly not "bottom" or "ground" Fishes in the same sense as, for example, are the Pleuronectidæ, and unless they habitually rest on the bottom when not in motion by the exercise of their fins like the Flat Fishes, it is clear that an air-bladder as a hydrostatic organ must be as useful to them as to other Fishes. Moreover, there are many facts which tend to prove that whenever any Ostariophyseæ assume a strictly "ground" habit, as, for example, in the Loaches (*Nemachilus*, *Cobitis*, *Botia*, &c.) among the Cyprinidæ, and such forms as *Glyptosternum*, *Exostoma*, *Eucliptosternum*, *Amblyceps*, &c., in the Siluridæ, the air-bladder necessarily becomes useless for hydrostatic purposes, and invariably undergoes more or less degeneration, just as it does in many other Teleostei (*e.g.*, Pleuronectidæ) under similar conditions, whereas by far the great majority of both families possess well developed and normally constructed bladders.

(2.) To a Fish at a depth of, say only 6 feet below the surface of the water, a variation of atmospheric pressure sufficient to raise or depress a column of mercury in a barometer to the extent of half-an-inch will only involve a variation of pressure amounting to less than one-tenth of the already existing hydrostatic pressure, and even this trifling difference will become relatively smaller as the depth at which the Fish lives becomes greater, while the ascent or descent of the Fish in the water to the extent of only 7 inches would certainly mask any variation of atmospheric pressure to the extent indicated. A barometrical variation of even half-an-inch takes place but slowly, and consequently could only be appreciated as distinct from hydrostatic



pressure on the somewhat improbable supposition that the Fish remained at exactly the same depth during the whole time that the barometrical variation was in progress. The maximum range of variation in atmospheric pressure, as measured by the barometer, is about 2 inches, but such variations occur only at considerable intervals of time, and then may take many hours to accomplish. But even in this extreme case the atmospheric pressure variation might be negatived as far as the Fish was concerned by ascent or descent in the water to the extent of 27 inches, or more or less completely masked by similar movements of less extent during ordinary locomotion, or by the rise and fall of the tide in the case of a few marine or estuarine Siluridæ.

We have not been able to examine any records relating to barometrical variations in regions where the Siluridæ or Characinidæ are most abundant, but the extent to which the Ostariophyseæ of the British Isles are exposed to atmospheric pressure variations may be readily tested. The only Ostariophyseæ inhabiting Great Britain are the Cyprinidæ, the various species of which are among the commonest and most abundant of British Fishes of fresh-water habitat. Ten genera and fifteen species of Cyprinidæ are known to inhabit this country (10A), and, omitting certain genera\* which have small bone-encapsuled air-bladders, there will still remain eight genera and thirteen species with normal, well-developed air-bladders in connection with a Weberian apparatus. It may, therefore, be worth while to ascertain the extent and variety of the barometrical changes to which these Fishes are liable. With this object we carefully examined the variations of the barometer as registered by the barograph of the Birmingham and Midland Institute Observatory during the three years 1886-1888. These records demonstrate (1) that variations of  $\cdot 50$  inch and upwards very rarely occur in less time than 10 hours, and generally require from 12 to 24 hours for their completion. In the three years on only two occasions did a variation so great as  $\cdot 50$  inch occur in less time than 10 hours; (2) variations amounting to  $\cdot 50$  inch and upwards in 24 hours are not common, occurring only fifteen times in 1886, fourteen in 1887, and seven times in 1888; (3) in only one instance did a barometrical rise or fall exceed 1 inch in 24 hours; excluding this very exceptional case, the most striking variations within this period ranged from  $\cdot 60$  inch to  $\cdot 82$  inch, and required from 15 to 24 hours for their completion; such variations happened but seldom, and are recorded only nine times in 1886, four in 1887, and four in 1888; (4) rapid and sudden variations, that is, those occurring within, say, 2-5 hours, are somewhat rare, and, almost invariably, are very small in amount, rarely exceeding  $\cdot 2$  inch. It may be reasonably concluded, therefore, that, so far as the Cyprinidæ of the British Isles are concerned, the variations of atmospheric pressure to which they are liable are too small in amount, too gradual in their progress, and too infrequent to exert any appreciable influence upon an air-bladder already subjected to considerable hydrostatic pressure, especially as the latter, instead

\* *Cobitis* and *Nemachilus*.

of being a constant factor, varies incessantly with almost every locomotor movement of these usually active Fishes, while the Fish can have no power of differentiating the effects due to the incidence of the two pressures. It also seems reasonable so far to extend this conclusion as to infer that if the extent and variety of the barometrical variations above recorded may be regarded as fairly typical of temperate or North temperate regions, the application of SAGEMEHL'S theory to the large number of species of Cyprinidæ which inhabit these areas must be open to very grave objections; and it is at least not improbable that a substantially similar line of argument may be applied with equal force in the case of the remaining Ostariophyseæ which are of tropical or subtropical habitat.

(3.) There is no clear evidence that the Ostariophyseæ are in any way different from other Fishes in being specially susceptible to atmospheric pressure variations, or that they possess any special capacity for anticipating impending changes in the weather. The only instance that we have been able to discover has reference to the European "Sheat Fish" (*Silurus glanis*), which is said to become greatly disturbed during the progress of thunderstorms (28A). But this isolated case certainly does not warrant the assumption that the air-bladder and Weberian mechanism are at all concerned in conveying the necessary stimulus to the nervous system of the Fish, inasmuch as at least two alternatives present themselves:—(1) One suggested by MURRAY, namely, that the Fish is excited by electricity. This is extremely improbable, and is rendered more so when we recall the fact that electrical currents do not readily pass from the atmosphere into water—especially fresh water. (2) The more probable alternative is that thunder, as is well known, causes considerable earth tremblings, which may be easily conceived as a possible source of uneasiness to the Fish.

(4.) Even if the truth of SAGEMEHL'S theory be admitted, it still remains very difficult to imagine what advantage these Fishes could derive from their ability to appreciate variations in the pressure of the atmosphere and consequent impending changes in the weather, nor is it easy to conceive in what way the Fish can adjust its habits or its locomotor activities in accordance with varying meteorological conditions. It might possibly be advantageous for certain marine species of active habit to be able to anticipate a storm and retreat to deeper and calmer waters; but even this advantage could only apply to very few of the Fishes in which a Weberian mechanism is present, and would be altogether superfluous in the case of the fresh-water species which form by far the great majority of the four or five families concerned.

If we regard SAGEMEHL'S barometrical theory as untenable, there remains only HASSE'S view that the Weberian mechanism constitutes a register of varying hydrostatic pressures, and this, in our opinion, is the only conclusion that has any foundation in fact. Seeing that the primary and almost universal function of the air-bladder, in spite of the occasional and secondary functions that may, in a relatively small number of Fishes, be grafted upon it, is that of acting as a hydrostatic organ, there is a strong

antecedent probability that the Weberian ossicles are directly related to this function. The general structure of the air-bladder, the mode of interconnection of the different Weberian ossicles, and their relations both to the air-bladder and to the internal ear, as well as the relations *inter se* of the different parts of the two last-mentioned structures, are perfectly consistent with this theory, against which no anatomical objections can be urged, and are equally inconsistent with any other at present suggested.

The division of the air-bladder into a small, elastic, and expansible anterior portion, and a relatively large, inelastic, and inexpandible posterior division, renders that organ admirably adapted for the measurement of the varying volumes of the contained gases, inasmuch as the volumetric variations in the relatively large volume of gas contained in the whole bladder will find their expression almost exclusively in corresponding alterations in the size of the anterior chamber through the expansion or contraction of its lateral walls, which alone are directly connected with the recording Weberian ossicles. Regarded, in fact, as an article of physical apparatus, the air-bladder may be compared with such instruments as, for example, the thermometer, by which the expansion or contraction of mercury or alcohol under the influence of changes of temperature is accurately measured. In both instruments there is a relatively large reservoir in free communication with a much smaller one, and the expansion or contraction of the relatively large mass of gas, or fluid, as the case may be, in the larger chamber is measured by the more readily observed expansion or contraction of the contents of the smaller chamber; and hence, there is a close functional parallelism between the anterior and posterior divisions of the air-bladder and the capillary tube and bulb of a thermometer respectively. Similarly it may also be said that the anterior chamber of the air-bladder is, to some extent, constructed on the principle of an aneroid barometer, inasmuch as the susceptibility of the recording lever (Weberian ossicles), connected with the former to the varying volumes of the contained gases, is considerably increased by the comparative rigidity of its anterior, posterior, dorsal, and ventral walls and the consequent restriction of any expansion or contraction to movements of its lateral walls alone, in much the same way that the expansion or contraction of the air contained within the metallic box of the aneroid will find its sole expression in corresponding movements of the flexible upper wall of the box, which alone is capable of transmitting such internal volumetric changes to the external recording lever; in fact, in a certain sense it may be said that the air-bladder of the Ostariophyseæ combines the structural principles of both the thermometer and the aneroid barometer. The varying relative dimensions of the anterior and posterior chambers of the air-bladder in different Siluridæ very probably bear some relation to corresponding variations in the delicacy of the Weberian mechanism as a pressure register in various species, for, as is the case with the analogous parts of the thermometer, the susceptibility of the mechanism should, within certain limits, increase as the posterior chambers become larger and the anterior chamber smaller.

The conclusion to which these facts seem irresistibly to point is still further strengthened by the condition of the air-bladder and Weberian mechanism in the *Siluridæ abnormales*, but as we shall subsequently have occasion to refer to these Siluroids at some length, we need now only say that in a large number of cases the degenerate and rudimentary condition of these structures is associated with the purely "ground" habit of these Fishes. It is well known that the assumption of a ground habit is in many Fishes accompanied by the degeneration, or even total disappearance, of the air-bladder, which, under such conditions, becomes useless as a hydrostatic organ, even if its retention is not distinctly harmful to the species, and hence its liability to degenerate to the condition of a more or less rudimentary structure, or become completely suppressed. The correlation of a similar habit of life with degeneration of the air-bladder and Weberian mechanism in the particular case of the *Siluridæ abnormales*, seems to us to furnish almost conclusive evidence that both organs are solely related to the normal hydrostatic function. As an accessory to audition, or even as a register of varying atmospheric pressures, or, indeed, as fulfilling any purpose other than the hydrostatic function, the air-bladder and Weberian mechanism might still be of some utility to these Fishes in spite of their change of habit, and therefore need not degenerate, but the fact that these structures do degenerate under such conditions seems to us to be only reconcilable with the conclusion at which on other grounds we have arrived.

Considered solely from an anatomical standpoint, and with the qualification which the absence of direct experimental evidence imperatively demands, it may be affirmed that HASSE'S theory is correct, and that the Weberian mechanism is a pressure register serving to acquaint the Fish with the varying tensions or volumes of the gases contained within its air-bladder, the result of corresponding variations of the hydrostatic pressure. As it is inconceivable that such pressure variations can arise from any other cause than the ascent or descent of the Fish in the water in the course of the ordinary locomotor movements, it may be further concluded that the Weberian mechanism is related to some form of pressure adjustment.

3. If the conclusion at which we have arrived be admissible, the further question—What advantage does the Fish derive from the possession of a pressure register by which it becomes acquainted with the varying degrees of hydrostatic pressure to which it is exposed? or, In what way does the animal respond to the sensory impulses communicated to its central nervous system by the Weberian mechanism and the co-adapted parts of the internal ear? is one to which it is very difficult to return a satisfactory answer. That the Weberian mechanism is of great functional importance to the Fish possessing it admits of no doubt. It is extremely improbable that so complicated and highly specialized a mechanism would have been evolved did it not confer some exceptional advantage upon its possessors, and that this is the case seems to be clearly demonstrated by the significant fact that the presence of a Weberian mechanism is characteristic of nearly all the dominant families of freshwater Teleostei.

Some light may possibly be thrown on this difficult question by a closer comparison of what is experimentally known of the methods of pressure adjustment in Fishes in general, and in the Ostariophyseæ, than has hitherto been made; and if no satisfactory conclusion can be arrived at in this way, some clue at least may be gained as to the direction in which the solution of the problem must be sought for in the future.

Gaseous secretion and absorption are, as we have seen, highly important factors in the majority of Fishes in the adjustment of the volume of gas in the air-bladder to varying hydrostatic pressures, and the conditions under which these pressures take place, have been experimentally investigated by MOREAU. Of the conditions which determine an increase in the rate of secretion of gas into the air-bladder, the most important are (1) repeated abstraction of gas; (2) increase of external pressure;\* (3) section of sympathetic nerve; and (4) the presence in the walls of the bladder of special retia mirabilia, or "vaso-ganglia." The process of absorption, on the other hand, is not so well understood, but certain conditions undoubtedly favour its action; these are (1) diminution of pressure, and (2) the existence of retia mirabilia. It will be obvious that the *rapidity* with which the amount of gas in an air-bladder can be augmented or diminished by secretion or absorption, is an important feature in this discussion, for on this will depend the capacity of the Fish to adjust itself to the varying pressures of different levels in ordinary locomotion; but unfortunately MOREAU'S experiments do not throw much light on the precise rate at which these processes take place. In many of his experiments, as, for example, in those dealing with secretion, the amount of gas previously abstracted was often so great that the time occupied by the process of secretion to restore equilibrium varied in different Fishes from several hours to several days, and similarly with absorption. No attempt has yet been made to obtain accurate measurements of the precise rate of secretion and absorption, under conditions involving relatively small and gradual variations of level and pressure. Three important facts appear however to be well established: (1) that gaseous secretion and absorption are relatively slow processes in all Fishes; (2) that although retia mirabilia are not indispensable to these processes, there can be no doubt that both take place much more rapidly in Fishes that possess such structures than in those in which they are wanting; and (3) that increased hydrostatic pressure accelerates the rate of secretion, while diminished pressure exerts a similar influence on absorption. With such data as these and other facts supply, we may consider more closely the methods by which in different Fishes the process of pressure adjustment is effected.

In the case of the Physoclisti, which very generally possess retia mirabilia, but no ductus pneumaticus, gaseous secretion and absorption must be the only means of

\* The effect of pressure on the secretion of oxygen is well illustrated by the observations of BIOT (2), who found that the amount of this gas in the air-bladder increases in direct proportion to the depth at which the Fish is found, and may even amount to 87 per cent.

adjustment to varying hydrostatic pressures, but how far this method is available during the changes of level which are encountered in ordinary locomotion is very doubtful, and on this point two suggestions may be made :—(1) It may be possible that the increase of external pressure which accompanies descent, conditions an increased rate of secretion, while a diminution of pressure during ascent involves a like acceleration of the absorptive process, with the result that if such vertical movements are not too rapid or sudden, or too extensive, the processes of secretion or absorption may keep pace with them, and the Fish retain a plane of equilibrium at all levels; (2) without entirely denying that the former suggestion may be true in some subordinate degree, it may yet be conjectured that pressure adjustment by such means is more likely to be of advantage to the Fish during slow or gradual changes of depth, such as may occur in the course of diurnal, seasonal, or other periodic migrations, than in such ordinary and rapid changes of level as are characteristic of normal locomotion. The slow rate of gaseous secretion and absorption renders it difficult to accept unreservedly the first alternative, and this objection is further supported by many features in their habits, which tend to prove that most Physoclisti have but a comparatively restricted vertical range, in so far as ordinary locomotor movements are concerned, as well as by certain facts already quoted.\* The second suggestion has also this much in its favour—that even a slow rate of secretion and absorption would be distinctly advantageous to these Fishes in view of the varying pressures to which they are exposed during periods of migration, whether the latter are due to variations in temperature and food supply, or to their breeding habits. On the whole we incline to the opinion that most Physoclists have but a restricted capacity for pressure adjustment during ordinary locomotion, and, in this respect, are less favourably situated than the Physostomi.

Leaving the Physoclists, we may next proceed to discuss in the light of MOREAU'S researches the mode in which pressure adjustment is effected in the Physostomi. The great majority of the wholly or partially freshwater families of this group possess both an air-bladder and an open ductus pneumaticus, and to these there is added, in the five families of Ostariophyseæ, a Weberian mechanism. The relatively few Physostomi that possess an air-bladder but have no pneumatic duct, are in precisely the same position as the majority of the Physoclisti, and whatever capacity for pressure adjustment they may possess must be due solely to gaseous secretion and absorption. Of the remainder it will be convenient to consider, in the first place, the Ostariophyseæ, and, secondly, those forms in which the air-bladder is said to possess an open ductus pneumaticus, but has no Weberian apparatus.

From the universal absence of *retia mirabilia* in all hitherto investigated Ostariophyseæ, it may be legitimately inferred that whatever capacity for gaseous secretion and absorption they may possess must be exercised with extreme slowness, and therefore as a means of pressure adjustment is of minor importance. On the other

\* See p. 278.

hand, MOREAU's researches clearly demonstrate that those Ostariophyseæ with which he experimented, possessed the compensating advantage of being able to substitute for absorption the mechanical liberation of gas through the ductus pneumaticus. This conclusion is also supported by many observations which go to prove that while free in the water and under normal conditions, many Cyprinidæ eject gas through the mouth on rising to the surface. Hence it follows that such Physostomi possess a distinct advantage over all Physoclisti in the fact that they can, during ascent, more rapidly adjust the volume of gas in the air-bladder to the requirements of a diminishing pressure by liberating the necessary quantity of gas than by relying solely on the slow process of absorption, and consequently will retain perfect freedom of movement at all points in the course of an upward career, even at the most superficial level. But while it must be admitted that in movements of ascent the Ostariophyseæ possess a distinct advantage over all Physoclisti, it is equally clear that in descent the converse must be true, inasmuch as the absence of retia mirabilia in the former group will render the process of adjustment to an augmented pressure a much slower one than is probably the case in the latter. On the other hand, as MOREAU points out, a Fish will incur more danger by rising above the plane of least effort than by sinking below it for the same distance. It is conceivable that a Physoclist in the course of rapid ascent might so far depart from its normal plane of equilibrium as to be forcibly carried to the surface of the water, and in that helpless condition fall an easy and conspicuous prey to predaceous birds or fishes before it could re-adjust by absorption the volume of gas in its air-bladder to the necessities of a more superficial level. A similar movement of descent, even if increased pressure so reduced the volume of gas in the bladder, and to an equivalent extent increased the specific gravity of the body, as to remove the Fish from its normal equilibrium, would probably involve no special inconvenience, while the gradual secretion of the necessary gas would, sooner or later, restore it to a plane of least effort at the deeper level. Like the Physoclist, and for the same reason, it is probable that the Ostariophyseæ incur no serious disadvantage in descent, although in this group the necessary readjustment by gaseous secretion takes place still more slowly. And, moreover, this apparent disadvantage may be open to some qualification, for it has been experimentally shown that an increase in the rate of gaseous secretion may be brought about not only by augmented pressure, but also by any abstraction of gas that may have occurred during a previous ascent. It is, therefore, possible that such conditions may lead to a more speedy readjustment to the greater pressure of a deeper level than at first sight might be supposed. These considerations seem to us to justify the conclusion that, as compared with the Physoclisti, the Ostariophyseæ possess a greater capacity for adapting themselves to rapid and considerable changes of level, more particularly in the direction of ascent, and that this is the case is to a large extent borne out by what is actually known of their habits and their greater freedom of movement at widely different levels.

The physiological relations of the Weberian mechanism to the hydrostatic function of the air-bladder constitute an extremely difficult problem, and one that can only be satisfactorily settled by experimental inquiry. If retia mirabilia were present, it might be conjectured that the Weberian ossicles formed part of a reflex mechanism by which the varying tensions of the gases in the air-bladder were rendered capable of so affecting the central nervous system as to reflexly lead to modifications in the way either of acceleration or retardation in the rate at which such gases were secreted or absorbed, and possibly in this way facilitate the more rapid adjustment of the volume of internal gas to the varying pressures of different depths. That the secretion of gas, and possibly its absorption also, are under the control of the nervous system has been experimentally proved by MOREAU in certain Physoclisti, but the absence of retia mirabilia in the Ostariophyseæ seems to us conclusive against assigning more than a very subordinate part to the mechanism, if any, in the way of controlling the secretion or absorption of gas in the latter group. On the other hand, it seems to us more reasonable to suppose that the Weberian mechanism controls the escape of gas through the ductus pneumaticus in the process of pressure adjustment during slow or rapid ascent. A gradual distension of the air-bladder would be accurately measured by its recording lever, the Weberian ossicles, and the increasing intensity of the stimulus imparted to the sensory epithelium of the internal ear and the saccular branches of the auditory nerve. The consequent reflex or voluntary efferent impulses may find expression in the exercise of some form of regulatory control over the liberation of gas through the ductus pneumaticus, so that only so much gas will be eliminated as will suffice to maintain the Fish in a plane of least effort at all levels during ascent, notwithstanding the reduction of external hydrostatic pressure. In a brief reference to this point RAMSAY WRIGHT (43) says that in Physostomous Fishes "accommodation to a new higher level is more quickly effected by the ejection of bubbles of gas through the air-duct," and again, in referring to the Ostariophyseæ, remarks that the Weberian mechanism "probably enables them to measure the precise amount of air which must be disengaged in order to restore equilibrium at a new higher level" (pp. 385-6). For reasons which we shall refer to subsequently, we cannot at present regard the first suggestion as applicable to the Physostomi in general, but, in so far as the Ostariophyseæ are concerned both suggestions agree with the tentative conclusions at which we also have arrived.

Unfortunately there is but little anatomical, and absolutely no experimental, evidence available as to how, or in what way, the escape of gas through the ductus pneumaticus is regulated or controlled in accordance with these conclusions. That the escape is in some way regulated is suggested by the fact that in the case of a Tench\* under artificially diminished pressure the air issued from the ductus in the form of bubbles, not continuously, but at intervals, as the pressure was gradually reduced. The intermittent escape of the gas certainly seems to indicate the existence

\* MOREAU, *loc. cit.*



of some obstacle to what would otherwise be a continuous and gradual evolution of gas, and also suggests the presence of some check or regulating mechanism which periodically limited the outflow in accordance with the requirements of a gradually diminishing pressure, and thereby enabled the animal to retain a constant plane of least effort, for even in a partially exhausted air-pump the Fish still swam about freely. On this point RAMSAY WRIGHT (43) remarks, "the mode in which the air is discharged in *Amiurus* is not known to me, but the duct, tortuous where it opens into the œsophagus, must be much straighter when the ventral wall of the anterior part of the air-bladder is distended than when such is not the case. Further investigation must show whether the duct participates actively in disengaging the air-bubbles, and if so, under the control of what nerve it does so" (p. 386). We cannot altogether agree with RAMSAY WRIGHT'S suggestion that the escape of air from a distended air-bladder may be facilitated by the straightening of a tortuous pneumatic duct, for, as we have elsewhere shown, the skeletal attachments of the anterior chamber are such that it has but little capacity for distension except through the outward bulging of its lateral walls, in which the ventral wall can scarcely, if at all, participate. Nevertheless, we are strongly inclined to agree with his suggestion that the ductus pneumaticus does actively participate in promoting the escape of gas and in controlling the rate of exit, and on this point some clue as to the nature of the process may be gained by a comparison of substantially similar mechanisms in other organs with certain facts of structure in connection with the air-bladder and pneumatic duct of the Siluridæ, but their truth or falsity only experimental inquiry can determine.

Comparative physiology furnishes many illustrations of the various methods by which the escape of partially solid or wholly fluid substances from the body, or from the organs, in which they are formed or temporarily stored, is regulated. A special sphincter muscle may surround the terminal outlet and be maintained in a normal condition of tonic contraction by impulses from a special nerve centre, the activity of which may be increased or inhibited by afferent impulses generated by appropriate external or internal stimuli. The sphincter ani may be taken as an example of this form of regulatory mechanism. Much more to the point, however, is the method by which the flow of bile from the gall-bladder to the small intestine in Mammalia is controlled. Both the cystic duct and the gall-bladder have muscular walls, while the terminal orifice of the common bile duct is said to be surrounded by a sphincter muscle. The relaxation of this sphincter and the contraction of the muscular walls of the gall-bladder and its duct may be brought about by a reflex action, in which the afferent impulses are due to the stimulus afforded by the passage of the acid contents of the stomach over the intestinal orifice of the bile duct, but nothing appears to be satisfactorily known either as to the nerve centre or to the path of the afferent impulses. It is clear that two distinct results follow the application of the stimulus and the initiation of afferent impulses, first, the inhibition of the centre by which the

tonic contraction of this sphincter is maintained, and secondly, the contraction of the walls of the duct and gall-bladder. The cystic duct in Man is always somewhat tortuous at its commencement, and this may furnish an explanation of the fact that very considerable manual pressure is required to expel the contents of the gall-bladder, at all events, after death, and at the same time suggests that the muscular contraction by which the bile is normally expelled is of a gradual and peristaltic character. Moreover, the tortuosity of the cystic duct may have some physiological significance in the sense that it acts as a valve and prevents mere abdominal pressure from producing a flow of bile into the intestine.

The air-bladder and pneumatic duct certainly exhibit some structural analogies to the gall-bladder and cystic duct, and it is by no means improbable that a close physiological parallelism may also exist with regard to the expulsion of their respective contents. It is true that the walls of the air-bladder are devoid of both intrinsic and extrinsic muscles, and they can have no power of expelling the gases they enclose by direct muscular compression, but muscular action is here unnecessary, inasmuch as the augmented tension and volume of the contained gases under diminished pressure will furnish the needful expulsive force. Mere manual pressure on the air-bladder has but little, if any, effect in expelling its gaseous contents, and that this is so is probably due to the tortuosity of the pneumatic duct, aided possibly by the action of a terminal sphincter, at or near its gastric or œsophageal extremity. On the other hand, the ductus pneumaticus in some Siluridæ, and possibly in all the normal species, contains unstriped muscular fibres. The reflex mechanism in the two cases may also be similar. Diminished hydrostatic pressure conditions an expansion of the volume of gas in the air-bladder, which will ultimately result in the transmission of a stimulus to the sensory epithelium of the internal ear, and the initiation of afferent impulses in the auditory nerve. The afferent impulses may find their final expression in the peristaltic contraction of the walls of the pneumatic duct and the expulsion in successive bubbles of an amount of air that will suffice to restore equilibrium at a new level. It is probable that the pneumatic duct is not to be regarded as a mere channel for the escape of gas from the air-bladder, but rather as a structure which, under reflex control, actively participates in the process, and, at the same time, regulates the quantity of the expelled air. Slight reductions of pressure, the result of equally slight variations of level, may not necessarily lead to an escape of air, for probably no inconvenience to the locomotion of the Fish would result from them, in fact, the tortuosity of the pneumatic duct, aided, it may be, by a special sphincter, can be regarded as of the nature of a safeguard to prevent the unnecessary elimination of gas under such conditions. But more extensive reductions of pressure may at once call into play the reflex mechanism to secure the necessary readjustment to the more superficial level. That the reflex mechanism is under the direct control of some special nerve centre is highly probable, and it is at least within the range of possibility that the activity of this centre may in turn be dominated by some still

higher centre whereby the processes involved in re-adjustment to constantly varying external pressures are brought under the voluntary control of the Fish.

A little additional light may, perhaps, be thrown on the nature of the regulatory mechanism by some remarks of DUFOSSÉ (11B). This writer describes the ductus pneumaticus in certain Ostariophyseæ, such as the Carp (*Cyprinus carpio*), the Barbel (*C. barbatus*), and the Miller's Thumb (*Cobitis barbatula*, LINN.) among the Cyprinidæ, as widening out into a trumpet-shaped orifice as it opens into the œsophagus, and that in this dilated part of the duct the mucous membrane presents several small duplicatures, which form valves so disposed as to prevent the exit of gas, the will of the animal and not the mere accumulation of gas being indispensable to overcome the valvular obstruction. DUFOSSÉ, however, regards these valves as forming a regulatory mechanism controlling the escape of air from the air-bladder by which these Fishes are rendered capable of producing certain voluntary sounds classified by him under the name of breathing noises, or "bruits de soufflement." In the absence of experimental evidence that such valves are related solely to the production of voluntary sounds, as DUFOSSÉ believes, it may not be altogether unreasonable to suggest that these structures may have something to do with regulating the expulsion of gas from the air-bladder under the influence of reduced hydrostatic pressure, and further that the breathing noises may only be the accidental concomitants of the latter function. At any rate, the existence of valvular structures in the ductus pneumaticus of, at all events, some few Ostariophyseæ affords an additional clue to the nature of the mechanism by which such Fishes may voluntarily or reflexly control the escape of air from the air-bladder.

Whatever may be the precise nature of the regulatory mechanism, the advantage to the Fish of some such method of carefully graduated adjustment to pressure variations as that we have suggested is sufficiently obvious. Without any kind of regulatory control, and with an open ductus pneumaticus in free communication with the exterior, it may be surmised that the escape of gas would be continuous and unchecked, and might even involve a more or less complete exhaustion of the gas in the air-bladder as the pressure diminished, with the contingent disadvantage that the normal equilibrium of the Fish in the water would be greatly disturbed, and a considerable demand be made on the secretive activity of the bladder for the subsequent restoration of the gas. On the other hand, the existence of a controlling mechanism would ensure that only so much gas would be evolved under such circumstances as might suffice to maintain the Fish in a plane of least effort, and at the same time secure the needful economy in the liberation of the gas.

There is another point of view from which, if the foregoing suggestions have any weight, the Weberian mechanism must be a source of considerable gain to all Fishes in which it is present. There can scarcely be any doubt that *all* Fishes, whether with or without this mechanism, must in ordinary locomotor movements encounter more or less extensive changes of level and pressure, although no doubt within limits

which vary with different species. A Fish without the mechanism relies solely upon the relatively slow processes of gaseous secretion and absorption for the readjustment of the volume of gases contained within its air-bladder to pressure variations, and for reasons already given we have arrived at the conclusion that such processes are of little value in ordinary locomotor movements involving rapid changes of level and pressure, although possibly of considerable advantage when such changes are incurred in the course of periodic or other migrations. It will follow, therefore, that in ordinary locomotor movements attended by rapid changes of level any departure from the normal plane of equilibrium must be accompanied by an increase or decrease of specific gravity to an extent proportional to the amount of the pressure variation. Hence in all such movements a corresponding increase of muscular exertion must take place which will necessarily be the greater in proportion as the variation of level carries the Fish away from its normal plane of least effort, and the result is the same whether the Fish has to counteract by muscular effort the effect of a too feeble specific gravity, or to sustain itself against an increase of specific gravity. On the contrary, all Fishes that have a Weberian mechanism possess also a greater capacity for pressure adjustment, and consequently at nearly all levels and pressures will retain a normal plane of least effort, with the correlative advantage that all their normal movements, however rapid, and whatever may be the plane in which they take place, will be executed with a minimum expenditure of muscular energy. We may fairly conclude, therefore, that the Weberian mechanism not only confers upon all Fishes that possess it an exceptional capacity for freedom of locomotion in all directions, and especially in the vertical plane, but also entails the contingent advantage that all movements will be effected with the maximum economy of muscular effort and tissue metabolism.

This seems to be about as far as the data at present at our disposal will warrant us in pursuing this discussion as to the function of the Weberian mechanism. The evidence at present obtainable is strongly in favour of the presumption that this singular mechanism is directly related to the hydrostatic function of the air-bladder; nevertheless, we cannot but feel that the tentative suggestions which we have ventured to make as to its precise utility, while by no means inconsistent with them, yet derive but little positive support from any morphological or experimental data at present known. We have ventured to discuss this question at some length in order that the issues involved may be clearly understood, and in the hope that it will receive the attention of the experimental physiologist, in whose hands the final solution of the problem must rest.

So far our remarks have been confined to the discussion of the methods by which pressure adjustment is effected in the Physoclisti and Ostariophyseæ, and there still remain for consideration a few Physostomi (*e.g.*, Clupeidæ, Salmonidæ, Murænidæ, &c.), in which the air-bladder is said to be provided with an open ductus pneumaticus,

but has no Weberian mechanism, and in which retia mirabilia are either present or wanting.\* Two questions are suggested by these Fishes: (1) Are they capable, like the Ostariophyseæ, of utilizing the ductus pneumaticus as a means of pressure adjustment? (2) If so, what disadvantage is entailed upon them by the want of a Weberian mechanism? A negative answer to the first question renders any further discussion unnecessary, inasmuch as the Fishes concerned will be in the same position as most Physoclisti so far as pressure adjustment is concerned, but an affirmative response, on the contrary, will necessarily involve the consideration of the second question. With regard to the first point the scanty evidence available is of a contradictory character, in fact, it is not at all clear in many cases how far the ductus pneumaticus admits of free communication between the air-bladder and the exterior, in one species only, *Muraena conger* [*Conger vulgaris*], has it been experimentally shown† that gas can be eliminated through the pneumatic duct when the Fish is exposed to artificially diminished pressure. On the other hand, the Salmonidæ are generally credited with the possession of an open duct, but the behaviour of one species of this family, the "Kilch," when drawn to the surface from deep water scarcely favours the supposition that any adjustment to reduced pressure by the mechanical liberation of gas can take place in this species. It is true that in this case the pressure reduction was considerable, although it can hardly be said to have occurred with exceptional rapidity, or at a greater rate than probably takes place in many Ostariophyseæ during ordinary locomotion. Moreover, in MOREAU's experiments with such Ostariophyseæ as the Carp and Tench, the Fishes were exposed to an artificial reduction of pressure, which, if not so great as in the case of the "Kilch," was at least considerable and rapid, and yet throughout the experiment the gradual liberation of successive bubbles of gas enabled the Fish to retain perfect freedom of swimming. It is therefore difficult to avoid the conclusion that the "Kilch" has either no open pneumatic duct, or, if it has, that the duct cannot be utilized for pressure adjustment. A further item of negative evidence is to be found in the fact that, while retia mirabilia are invariably wanting in all Ostariophyseæ, they are present or absent in the remaining Physostomi in much the same way, and to the same extent, that they are present or wanting in the Physoclisti, and this certainly suggests the inference that gaseous secretion and absorption are important factors in pressure adjustment in these Fishes. From the same point of view it is somewhat significant that wherever the mechanical liberation of gas has been proved to take place in Fishes other than the Ostariophyseæ it is, with one exception (*e.g.*, *Conger*), by some other and secondarily acquired means than the retention of the ductus pneumaticus for the purpose. Thus MOREAU has shown that the Physoclist *Caranx trachurus* is capable of liberating a continuous stream of air through its "canal de sûreté" when exposed to artificially diminished pressures. In

\* A few Physoclisti (*e.g.*, *Holocentrum*, *Priacanthus*, *Casio*, &c.), in which, on the authority of KUER (21), an open ductus pneumaticus is present, may also be included.

† MOREAU, *loc. cit.*

the light of such contradictory and mutually destructive evidence no satisfactory conclusion seems possible, but two alternative suggestions may be made. If the ductus pneumaticus cannot from any cause or other be used for the mechanical liberation of gas, then, in these Fishes, as in the typical Physoclisti, gaseous secretion and absorption must be the only methods of pressure adjustment. On the other hand, even if it be admitted that some Physostomi without WEBER'S mechanism can liberate gas through the pneumatic duct, it is nevertheless not difficult to see how it may be that the process is of little use to them for pressure adjustment. The completeness of the control exercised over the liberation of the necessary amount of gas will largely depend on the perfection of the reflex mechanism employed in the process, and in all the Fishes now under consideration the necessary afferent impulses must be initiated in the general peripheral nervous system by the diffused pressure exerted by a distended air-bladder on the surrounding organs, instead of in a particular afferent nerve by a stimulus applied to a localized sensory epithelium through a highly specialized arrangement of movable ossicles as is the case with the Ostariophyseæ. The indefinite character of the stimulus in the former would certainly militate against any delicacy in the process of adjustment, even if it did not altogether prevent the possibility of any such adjustment. The more perfect afferent mechanism of the Ostariophyseæ conditions a more effective control over the function of the pneumatic duct, and a greater capacity for regulating the processes involved in pressure adjustment, and it may also be that this is the precise advantage which the Weberian mechanism confers upon all Fishes that possess it.

It may be admitted that this suggestion does not necessarily preclude the possible use of the duct as a safety valve in certain cases, but it does negative the probability that any effective control can be exercised over the liberation of gas in ordinary locomotion.

We cannot conclude this section of our paper without remarking that it would be extremely interesting to compare the behaviour of a Physostomous Fish without a Weberian mechanism with one in which this mechanism is present, when exposed both to rapid and gradual variations of pressure. A careful and experimental comparison of the methods and rate of adjustment in the two types under such conditions should go a long way towards the discovery of the true function and utility of the Weberian apparatus.

There yet remain certain points in connection with the air-bladder of the Siluridæ which it is desirable should be discussed from a physiological point of view; these are (*a*) the lateral cutaneous areas; (*b*) the "elastic-spring" apparatus of MÜLLER; (*c*) the extrinsic muscles of the Pimelodinæ; and (*d*) the distinctive features of the air-bladder and Weberian mechanism in the Siluridæ as compared with other Ostariophyseæ.

(*a.*) *The lateral cutaneous areas.*—The close relation between the lateral walls of the anterior chamber of the air-bladder and the adjacent superficial skin, which is so

characteristic of all the Siluridæ normales, and as equally conspicuous by its absence in all other Ostariophyseæ, may possibly have some physiological significance. SAGEMEHL (*loc. cit.*) has already referred to this feature in certain Siluroids, and suggests that, physiologically, it enables certain advantages to be realized, which, in other Ostariophyseæ, are gained by the bipartite structure of the air-bladder. In referring to the two-chambered air-bladders of the Cyprinidæ, Characinidæ, and the Gymnotidæ, he directs attention to the fact that this subdivision of the air-bladder occurs in no other Teleostei, and is always associated with the presence of a Weberian mechanism. The variable ratios of pressure of the surrounding medium condition the increase or decrease of the volume of gas contained in the whole air-bladder, and, owing to the peculiar structure of that organ, these variations of volume will find their expression almost exclusively in corresponding oscillations in volume of the small elastic anterior chamber, to which alone the Weberian ossicles are related, the larger posterior sac being scarcely, if at all, affected. A similar bipartition, the same writer also remarks, occurs only in a few Siluridæ, among which are mentioned, apparently on the authority of VALENCIENNES, *Auchenoglanis*\* and *Auchenipterus*. But in the case of the latter family SAGEMEHL says that the same physiological result is arrived at in an entirely different way. In many Ariinæ, and also in such Siluridæ as *Callichrous*, *Cryptopterus*, and *Schilbe*, the air-bladder is not confined to the abdominal cavity proper, but its lateral portions extend outwards between the ventral and dorsal portions of the lateral trunk muscles, quite close to the external skin. In this manner, SAGEMEHL remarks, the air-bladder acquires a tolerably direct connection with the external medium, and will, therefore, much more promptly react to pressure oscillations than if entirely confined to the abdominal cavity.

SAGEMEHL is scarcely correct in attributing any important physiological distinction between the obviously bipartite air-bladders of the Cyprinidæ and the Characinidæ and the air-bladders of the normal Siluridæ. In both cases the air-bladder is physiologically two-chambered in the sense that it consists of a smaller distensible anterior portion and a larger posterior and indistensible part, but in the Cyprinidæ the bipartite character is obvious externally, whereas in the Siluridæ it is only by internal examination that the essentially bipartite nature of the air-bladder becomes obvious. In fact, in all the normal Siluridæ the air-bladder is, physiologically, as truly bipartite as in other Ostariophyseæ, and the former derive precisely the same physiological advantage in the registration of hydrostatic pressure variations from this fact as do the latter. Neither is SAGEMEHL quite accurate in supposing that *Auchenoglanis*\* and *Auchenipterus* possess an air-bladder which is bipartite externally as in the Cyprinidæ, inasmuch as we have already shown, in the morphological section of this paper, that in both genera the bladder is substantially similar to that of all other Siluridæ normales so far as this point is concerned. SAGEMEHL's suggestion that the

\* *Auchenaspis*, BLEEK.

close relation of the lateral walls of the air-bladder to the external skin, and therefore to the surrounding medium, enables the air-bladder more promptly to react to pressure oscillations is, perhaps, not improbable, and, if such be the case, would certainly have the effect of rendering the Siluridæ much more sensitive to variations of hydrostatic pressure than is the case with other Ostariophyseæ where the air-bladder is separated from the external skin by the lateral lobes of the liver and other abdominal viscera. While admitting the feasibility of this suggestion, we may point out that the connection of the air-bladder with the superficial skin would also enable variations in the size of the air-bladder, the result of pressure variations, more promptly to modify the volume and specific gravity of the Fish, for any expansion or contraction of that organ from such causes must at once lead to the inward or outward bulging of the lateral cutaneous areas. The special advantage of lateral cutaneous areas to these Fishes, from this point of view, would lie in the fact that their greater susceptibility to alterations of volume and specific gravity would probably ensure a corresponding increase in the delicacy of the responsive processes involved in pressure adjustment.

The possibility, however remote, that these anatomical features have no special physiological value, but are simply the necessary result of other structural modifications of undoubted utility, must also be kept in view. The relative shortness of the abdominal cavity in many Siluroids may have caused the lateral expansion of the air-bladder and its consequent abutment against the external skin. That this may be the case is suggested by the practical suppression of the lateral cutaneous areas in some Siluridæ (*e.g.*, *Malapterurus*) where the abdominal cavity is of greater relative length than usual. One of the conditions of the formation of lateral cutaneous areas, *viz.*, the dorsal deflection of the dorso-lateral trunk muscles, may be only a necessary consequence of the elongation and expansion of the transverse processes of the fourth and fifth vertebræ, and their disposition at right angles to the long axis of the vertebral column for the investment of the dorsal wall of the anterior division of the air-bladder. In the Cyprinidæ, where lateral cutaneous areas are wanting, the transverse processes of the fourth vertebra are of considerable length without being specially expanded, but, like true ribs, their marked ventral flexure prevents them interrupting the straightforward course of the lateral trunk musculature, or producing any upward deflection of the dorso-lateral muscles. If this alternative view is at all a reasonable one, it will follow that the existence of the areas will primarily depend on the investment of the dorsal surface of the anterior chamber by the expanded transverse processes, which in turn must be regarded as a contrivance for preventing the dorsal expansion of the chamber during pressure variations, thereby restricting such alterations of volume to movements of the lateral walls alone.

(*b.*) *The "Elastic-spring" Apparatus.*—In the great majority of the Ostariophyseæ the escape of air from the air-bladder through the ductus pneumaticus apparently takes place only as the result of the expansion of the contained gases under the



influence of diminished hydrostatic pressure, although it is possible that the rate of overflow may in some way be regulated. In some few Siluridæ, however, there does seem to exist a special mechanism by which, under certain conditions, the air-bladder may be subjected to considerable compression, and the air which it contains either forcibly expelled, or greatly reduced in volume by condensation. This mechanism presents two important modifications, viz., the "elastic spring apparatus" and the powerful extrinsic muscles of the Pimelodinæ. In the case of the "elastic spring apparatus" it would seem that by the contraction of its powerful protractor muscle each spring can be drawn forwards towards the head, while the subsequent relaxation of the muscle will at once enable the spring to exert its full pressure on the air-bladder. JOHANNES MÜLLER regarded this apparatus as a mechanism through which the condensation or rarefaction of the gases in the air-bladder became a motive force in causing the Fish to rise or fall in the water. On this view it is presumed that the contraction of the protractor muscles will pull forwards the anterior wall of the air-bladder to which the elastic springs are attached, and by that means lead to the expansion of the bladder and the rarefaction of its contained gases; while, on the contrary, the relaxation of the muscles will at once allow the springs, by their own elasticity, to compress the air-bladder, condense the gases within it, and consequently increase the specific gravity of the Fish. As MÜLLER remarks, condensation and rarefaction are placed under the action of two powerful and opposite forces, in such a manner that condensation results from the elasticity of a recoil, while rarefaction depends upon the action and persistence of an essentially muscular force which annihilates the recoil.

We cannot quite agree with MÜLLER that the elastic springs can have any share in dilating the air-bladder, or rarefying the gases which it contains. The bony plates in which the two springs terminate distally are only applied to the anterior wall of the air-bladder, and the fibres of the latter are not directly attached to, or inserted into, the plates at their points of contact, and it is, therefore, difficult to see how the forward movement of each spring can possibly draw the antero-lateral wall with it, or rarefy the contained gases by increasing the internal capacity of the air-bladder. It is quite true that the transverse membrane which is so closely applied to the anterior wall of the bladder is also continuous with the inner (or anterior) and ventral margins of the terminal long plates, but we have never been able to detect any connection between the latter and the component fibres of the tunica externa of the antero-lateral regions of the bladder itself. But even if it be true that the antero-lateral walls can be drawn forwards in the way which MÜLLER'S theory requires, it still seems to us extremely doubtful that any increase of internal capacity would necessarily result, inasmuch as any outward bulging in the antero-lateral regions would almost certainly be attended by an inward bulging elsewhere. The mobility and elasticity of the transverse process which forms each spring will certainly give to the lateral portions of the anterior wall that capacity for sharing in the distension of

the anterior chamber which is prevented in all other Siluridæ by the absolute rigidity of the processes in question, but it is at the same time equally clear that the "elastic spring" apparatus cannot possibly give the Fish any power of directly compressing the air-bladder, except under certain conditions, viz., when the anterior chamber becomes distended through the diminution of pressure which occurs in movements of ascent, coincidentally with the forward movement of the two springs as the result of the voluntary or reflex contraction of their protractor muscles. Under such circumstances the mechanism potentially acquires the power to modify the capacity of the air-bladder, for the subsequent relaxation of the muscles will at once enable the springs, through the force of their own recoil, to exert their full strength in compressing both the air-bladder and its gaseous contents.\* If, therefore, the elastic springs can have no share in promoting ascent by rarefaction, and can only be called into action under conditions in which the distension of the air-bladder from pressure reduction is a necessary factor, the possibility that the mechanism is related to pressure adjustment is at once suggested. Tentatively adopting this suggestion it would seem that two alternative views may be taken as to the precise mode in which this singular mechanism is of practical utility :—

(1.) That the compression of the air-bladder, under the conditions and by the means already indicated, will effectually aid the action of the ductus pneumaticus in producing a more rapid and forcible ejection of gas, and at the same time secure the more rapid readjustment of the Fish to the reduced pressure of a more superficial level.

(2.) The advantage of a more rapid readjustment to diminished pressure may be gained by means of the "elastic spring apparatus" without necessarily involving a mechanical liberation of gas. The mere compression of the air-bladder would seem to be perfectly competent to prevent over-distension under a diminishing external pressure by simply condensing the contained gases, and so counteract the possible evil results of a too low specific gravity. If it be admitted that the Ostariophyseæ can control, or, if need be and occasion requires, entirely prevent the escape of gas through the pneumatic duct, it may easily be the case that pressure adjustment in those Siluridæ with an "elastic spring" mechanism can be more readily brought about by condensation without the actual expulsion of gas.

The sole advantage of the first alternative method is that it will secure a more rapid adjustment during ascent than is probably the case in most other Ostariophyseæ; on the other hand we incline to the opinion that the augmented tension of

\* Should this view of the mode of action of the "elastic spring" apparatus prove correct, it will be difficult to see how the mechanism can have anything to do with the production of voluntary sounds, as suggested by SÖRENSEN (36), inasmuch as the Fish would only be able to exercise its vocal powers under conditions involving pressure reduction during ascent from a deeper to a more superficial level. Under such conditions only does it seem likely that the contained gases would be expelled with sufficient force to produce any definite or characteristic sounds.

the gas itself under such conditions will constitute a sufficient expulsive force and render any special mechanism for the purpose altogether superfluous. The more obvious value of the second alternative lies in the fact that, while it may prove to be a method of adjustment even more rapid than the first, it also possesses the contingent economical advantage that as no gas has been lost by mechanical liberation, there will be no demand on the activity of the walls of the air-bladder for the secretion of additional gas when the Fish returns to a deeper level and greater pressure. On this view the processes of pressure adjustment will not consist in the actual expulsion of gas and its subsequent slow replacement by secretion, but rather in the volumetric changes of a fairly constant quantity of gas, which are affected by the action of the "elastic spring" apparatus, and are always of the opposite character to those which the external hydrostatic pressure tends to produce. Of the two alternatives the second seems to us the more feasible, but experiment alone can determine the accuracy of either, while it may prove the falsity of both.

In a limited sense our second suggestion is in accordance with MÜLLER'S theory, at least to the extent that condensation may be produced by the action of the elastic springs, although, as we think, for a different purpose than that which the theory maintains, but his view that the mechanism enables the Fish to ascend through the rarefaction of the contained gases must, for the reasons previously given, be regarded as entirely without foundation, and, to say the least, it is extremely doubtful if condensation can be of much, if any, use in facilitating descent. But apart from the special objections to the theory there are others of a more general character, based on the apparent uselessness of any special mechanism for causing the rise or fall of the Fish in the water. It has been previously pointed out that to Fish in approximate equilibrium the slightest action of the ordinary locomotor organs is quite sufficient to produce either ascent or descent, and the existence of an elaborate mechanism for varying the internal capacity of the air-bladder and the volume of the enclosed gases with this object is altogether unnecessary. These objections to MÜLLER'S theory will apply with equal force whether it be presumed that condensation, or the actual expulsion of gas, is the prime agent in promoting descent. On the other hand the unquestionable importance to the Fish of rapid and accurate methods of pressure adjustment is highly suggestive that the "elastic spring" mechanism is solely related to this function. We prefer, therefore, to regard the mechanism as a contrivance for expediting the process of pressure adjustment when the Fish is exposed to a rapid reduction of pressure during quick ascent, which, far more than descent, necessitates both rapidity and accuracy in the readjustment processes, and this view may reasonably be adapted whichever of the two alternatives is accepted as to the precise method employed. Should our views on this point prove to be correct, it would be reasonable to anticipate that of all the Ostariophyseæ these Siluridæ are best qualified for rapid and extensive vertical locomotion under conditions the most favourable to

the retention of perfect equilibrium at all levels within the range of their normal movements.

(c.) *The Extrinsic Muscles of the Air-bladder in the Pimelodinae.*—A function substantially similar to that of the “elastic spring” apparatus may, in all probability, be assigned to the powerful compressor muscles of the Pimelodinae. These muscles cannot possibly have any share in dilating the air-bladder and rarefying the contained gases in order to facilitate ascent, but it would certainly seem that they enable these particular Siluridæ to exercise a still more effective control over its distension, inasmuch as the muscles are apparently able to compress the air-bladder at all times, although more effectively, no doubt, when the latter is more or less distended. By the contraction of these muscles during rapid movements of ascent the tendency to over-distension on the part of the air-bladder will be promptly counteracted, while a forcible expulsion of gas through the pneumatic duct would enable the Fish to speedily adjust its volume and specific gravity to a new plane of least effort at the more superficial level. As in the case of the “elastic spring” apparatus of other Siluridæ, it is of course possible, theoretically, that the special advantage of the compressor muscles may be realised without necessarily involving the mechanical liberation of gas from the air-bladder. Excessive distension may be guarded against, and pressure adjustment effected by compression alone, the contained gases being so far condensed that no harmful reduction of the specific gravity of the Fish can take place, and, as before, accuracy and rapidity of pressure adjustment would, by this method, be correlated with the further advantage of economy in gaseous secretion.

In both series of Fishes it is extremely interesting to recall the existence of a special arrangement by means of which the compression of the air-bladder, either by the action of the “elastic springs,” or by the contraction of special compressor muscles, is prevented from imparting a too violent shock to the Weberian mechanism, and more especially to the fluids and sensory epithelia of the internal ear. In the Pimelodinae the contraction of the muscle which we have named the tensor tripodis, taking place coincidentally with that of the compressor muscles, will effectually limit the violent excursions of the crescentic process of each tripus, which, otherwise, would certainly take place when the anterior chamber of the air-bladder is forcibly compressed in the way described. In those Siluridæ provided with the “elastic spring” mechanism, a precisely similar result is brought about by the existence of a groove at the junction of each terminal bony plate with its flexible and elastic root, into which the outer margin of the crescentic process of the tripus is received. During the compression of the anterior chamber by the “elastic springs,” the outward movement of the crescentic process is controlled by the inward movement of the elastic spring itself, which has the result of effectually checking any sudden or extensive excursion on the part of the tripus, and, at the same time, prevents the transmission of a too violent impulse to the Weberian ossicles and internal ear.

The extreme difficulty of attempting to arrive at a satisfactory solution of the

various problems arising out of the physiology of the air-bladder, through anatomical data alone, is again forcibly illustrated, for it is impossible entirely to exclude the possible relation of the extrinsic muscles of the Pimelodinæ to the function of sound production, and it may also be the case, although perhaps less likely, that the same reservation will also apply to the "elastic spring" mechanism. That a violent expulsion of air from the air-bladder should produce definite sounds is extremely probable, but how far such sounds can be considered as related to the primary function of these muscles, or as merely accidental concomitants to it, must for the present remain an open question. SÖRENSEN (36) has adopted the former suggestion, and regards both the compressor muscles and the "elastic spring" mechanism as being subordinate to sound production. Nevertheless, in the absence of confirmatory experimental evidence, we still think it worth while to direct attention to an alternative interpretation of the function of these structures, which is at least as consistent with their morphology as any other view at present suggested. We have elsewhere (p. 270 and p. 298) suggested certain difficulties, which, in our opinion, are serious objections to SÖRENSEN'S views on this point.

(d.) *The Siluridæ compared with other Ostariophyseæ.*—In our morphological summary, and elsewhere, we have drawn attention to the more salient features wherein the air-bladder and Weberian mechanism of the Siluridæ differ from the corresponding structures in those Ostariophyseæ which in these, as in other respects, are the most closely allied to them, viz. :—the Cyprinidæ, and we may now briefly consider such distinctions from a purely physiological standpoint. As the morphological result of a comparison of the two families was to demonstrate the increased specialisation of these structures in the Siluridæ it is highly probable that a similar comparison, from a functional point of view, will prove the increased sensitiveness of the latter to hydrostatic pressure variations, and, at the same time, suggest a corresponding advance in the accuracy of the readjustment processes. An important factor in this direction in the Siluridæ is the restriction of all variations in the capacity of the anterior chamber under the influence of pressure variations to lateral expansion or contraction, from which it must follow that the auditory organ will be rendered susceptible to smaller variations of pressure than is the case in the Cyprinidæ where expansion and contraction are less strictly localised, and probably take place to a nearly equal extent in all directions. To the same object must also be attributed the subdivision of the posterior section of the air-bladder in all normal Siluridæ into two lateral compartments by a vertical longitudinal septum, as well as the frequent presence of secondary transverse septa in each chamber, such structural features can scarcely have any other effect than that of rendering this portion of the air-bladder more inelastic and indistensible than it would otherwise be, and, therefore, still further restricting all volumetric variations to the anterior chamber alone. It is also possible that the presence of lateral cutaneous areas may be related to the increasing sensitiveness of the air-bladder of the Siluridæ to pressure disturbances, if, as

SAGEMEHL (*loc. cit.*) has suggested, the function of these areas is to enable the air-bladder more promptly to react to pressure oscillations, or, as we have surmised, more readily to allow variations in the volume of the contained gases to modify the bulk and specific gravity of the Fish.

The comparative freedom of the anterior vertebræ from anchylosis in the Cyprinidæ is obviously related to the fact that the air-bladder, including the anterior chamber, lies free in the abdominal cavity, and is scarcely, if at all, invested by skeletal elements; hence, as the bladder is less likely to be affected by any compression which may result from the flexure of the vertebral column during vigorous locomotor movements, anchylosis is unnecessary, or at all events does not take place to anything like the same extent as in the Siluridæ.

Certain distinctive structural variations in the Siluridæ are probably dependent upon other modifications of a more direct physiological value, and in any comparison with the Siluridæ it is interesting to notice the necessary sequence of particular anatomical differences between the two when an initial modification is once started in one of them. In the Siluridæ, the restriction of volumetric variations in the anterior chamber to its lateral expansion or contraction is in part brought about by the investment of its dorsal surface by the complex and fifth centra and the expanded and otherwise modified transverse processes of the fourth and fifth vertebræ, which not only prevents the expansion of the chamber dorsally, and to some extent anteriorly, but indirectly aids in preventing expansion in other directions by affording the necessary surface for the direct attachment of the walls of the chamber to the skeleton at certain definite points. But to prevent the flexure of the trunk vertebræ in ordinary locomotion from exerting any influence on an air-bladder so closely related to the skeleton, and secondarily on the Weberian ossicles, a more or less extensive anchylosis of the anterior vertebræ takes place, as well as a more rigid and intimate articulation with the skull than is usually the case in other Ostariophyseæ. The necessity for a more rigid connection between the skull and the vertebral column has probably conditioned further modifications in the anterior vertebræ, and may well have been one of the causes which have hastened the further atrophy of those rudimentary vertebral centra that intervene between the basioccipital and the fourth vertebra, and have been partially dismembered in the formation of the different Weberian ossicles from certain of their constituent elements. The shortening of this section of the vertebral column necessarily involves the tripus taking a position more anterior than that which it occupies in the Cyprinidæ and exactly opposite the scaphium, with the final result that the intercalarium becomes useless as a sesamoid ossicle, and degenerates to the insignificant and variably developed vestige by which alone it is represented in the great majority of the Siluridæ.

On the other hand, it is not easy to attach any precise physiological significance to the fact that the saccus paravertebralis in the Siluridæ has entirely lost that communication with the cranial cavity which it possesses in the Cyprinidæ, nor to certain

minor differences in the degree of development and the mutual relations of the different Weberian ossicles in the two families. Perhaps the most important difference is the removal of the two claustra from any obvious physiological relations with the atrial cavities in the Siluridæ, and it is by no means clear whether this should be regarded as a loss or a gain from a physiological point of view.

Of the remaining families of the Ostariophyseæ the Characinidæ closely resemble the Cyprinidæ in so far as the points now under discussion are concerned, and of the Gymnotidæ it may be said that they exhibit a somewhat less specialized condition of the air-bladder and Weberian ossicles than any of the preceding families, although obviously related to the Cyprinoid type.

The conclusion suggested by these facts seems to us to be this—that, physiologically considered, the most important distinctive features of the Weberian mechanism in the Siluridæ as compared with other Ostariophyseæ are mainly related to the air-bladder, which in the former attains its maximum degree of specialization as an organ adapted for the registration of varying hydrostatic pressures.

#### B. *Siluridæ abnormales.*

In considering, from a physiological point of view, the significance of the structural modifications presented by the air-bladder and its adjuncts in this section of the family, we may, in the first place, briefly capitulate certain anatomical facts already mentioned in a previous section of this paper.

Apart from a very considerable reduction, both in absolute and relative size, the absence of lateral chambers and the persistence of the anterior chamber only, the most noteworthy features in the air-bladder of the various genera of Siluridæ abnormales are—its constriction, partial or complete, into two laterally-situated air-sacs, which may not only lose all connection with each other, but with the œsophagus also; the tendency of the air-sacs to become more or less completely enclosed within variously-formed bony capsules; the occasional atrophy of the ductus pneumaticus, or its persistence as a solid fibrous cord; and frequently also, in addition, the more or less complete atrophy of the fibres which normally form the dorsal walls of lateral halves of the bladder, and connect the lateral walls with the crescentic processes of the tripodes. To these may be added the partial solidification of the organ in certain species, either through the thickening and matting together of its walls, or the development of internal fibrous trabeculæ, or through the partial obliteration of its cavity through the growth of a thick central column of fibres. With the exception of the intercalaria, which are often absent, without, however, in any way interfering with the complete anatomical connection of the tripodes with the scaphia and the claustra, which apparently have no functional significance in the Siluridæ, the remaining Weberian ossicles are fairly well developed, and retain their normal relative size. Traces of degeneration are, however, to be met with. The tripus generally loses its

characteristic crescentic curvature—a modification which is often associated with the more or less complete atrophy of the fibres that normally converge to this ossicle from the lateral walls of the air-bladder, and even when these fibres are present the loss of curvature may be due to the fact that reduction in the size of the bladder is not accompanied by a corresponding diminution in the size of the tripus itself, which, therefore, receives the insertion of fewer fibres than in most *Siluridæ normales*. The scaphium as frequently retains but a vestige or loses all trace of its ascending process, and, as the condylar process may also disappear, the ossicle often becomes reduced to the condition of a simple concavo-convex structure in relation with the external atrial aperture.

As regards the effects of degeneration of the air-bladder on the structure of those portions of the internal ear which are specially related to the Weberian ossicles, we are satisfied that in, at least, some *Siluridæ abnormales* the sinus endolymphaticus has completely disappeared, although the ductus endolymphaticus, the cavum sinus imparis, and the atrial cavities remain, and retain also their normal relations to one another and to the scaphia. The absence of a sinus endolymphaticus in several genera with rudimentary air-bladders is at least suggestive of the probability that it is also wanting in other Siluroids in which the air-bladder has undergone a like degeneration; on the other hand, we entertain no doubt as to the presence of an apparently functional sinus in a few *Siluridæ abnormales*. Physiologically, the suppression of the sinus endolymphaticus must prove a serious obstacle to the transmission of afferent impulses generated by varying external pressures to the sensory epithelium of the sacculi, even supposing that the air-bladder and Weberian ossicles still retained their normal structure and mutual relations; but that it is a fatal obstacle cannot, in our opinion, be so readily affirmed, for movements in the fluids of the atrial cavities and cavum sinus imparis might still impinge on that portion of the ductus endolymphaticus which is in relation with the anterior aperture of the cavum.

Even if the diminutive air-bladder of the *Siluridæ abnormales* retained its structural integrity in other respects, the almost universal atrophy of the lateral chambers would certainly have the effect of rendering the bladder far less delicate as a register of varying hydrostatic pressures than it is in the normal section of the family, but taken in conjunction with such other retrogressive changes both in the air-bladder and Weberian mechanism as those above mentioned, it becomes almost impossible to believe that any function of the kind suggested can be assigned to these structures, or that they do otherwise than present various stages of retrogressive modification towards the condition of vestigial and functionless organs; and this conclusion seems to us equally inevitable whatever may have been their original function—whether acoustic, barometrical, or hydrostatic. Considering the high degree of specialisation which characterises the air-bladder and Weberian mechanism in the *Siluridæ*, it is by no means surprising that these structures should be liable to rapid degeneration when from any cause the necessity for the exercise of their special



function no longer exists, and the extraordinary variations which they often exhibit in different Siluridæ abnormales can only be regarded as furnishing abundant illustrations of the extreme variability to which all degenerate and useless organs are liable.

The widespread degeneracy of the air-bladder in the Siluridæ is amply proved by the fact that of the one hundred and sixteen genera mentioned in the British Museum Catalogue of the family, no fewer than twenty-five are referable to the Siluridæ abnormales, and it is extremely probable that further investigation, especially among the various mailed Loricaroid forms and their naked allies, will considerably add to the number of Siluridæ with degenerate and functionless air-bladders.

The causes that have led to the degeneracy of the air-bladder in so many forms are in many instances not difficult to trace, and, as in so many Physoclist Teleostei, the assumption of a purely ground habit of life is probably the most important one. Not a few of the genera of Siluridæ abnormales inhabit the comparatively shallow waters of rapidly flowing mountain streams and torrents, often living at a considerable altitude, and in general habit are not unlike our common English Loaches. Many are provided with an adhesive apparatus on the ventral surface of the body between the pectoral fins for attachment to stones, so that they may be enabled to withstand the force of mountain torrents. Such Fishes when not in motion by the exercise of their fins probably rest upon, or attach themselves to, the river bottom, and the utter uselessness and probable harmfulness of an air-bladder as a hydrostatic organ under such conditions is no doubt the cause of its degenerate and rudimentary condition in such Siluroids as *Sisor*, *Pseudecheneis*, *Glyptosternum*, *Eucliptosternum*, *Exostoma*, *Amblyceps*, &c. Although very different from the latter in the character of their habitat a similar explanation will probably apply also to such widely dissimilar forms as *Callichthys* and *Clarias*. Various species of *Callichthys* are said\* to keep under plants in marshy swamps, to be able to burrow in the mud, in which they often become dried up, and even to be capable of migration upon land in search of water. On the same authority *Clarias magur* is said to often frequent ponds and ditches, and, when the water dries up, to become imbedded in the mud, where it sojourns until the advent of the next rainy season. The same species is said to possess exceptional vitality when removed from its natural habitat. From their partially amphibious and grovelling habits it is clear that an air-bladder can be of little use to these Fishes as a hydrostatic organ, and hence its rudimentary condition. Similar remarks will in all probability apply to such other *Clarias*-like forms as *Saccobranchus* and *Heterobranchus*, and probably also to many other Loricaroid types in addition to *Callichthys*, about which we have not been able to glean much positive information as to their habits. The position of the mouth and the retroverted and Loach-like character of the lips in so many Loricaroid genera is strongly suggestive of their grovelling habits, and the consequent uselessness of an air-bladder.

\* CUVIER et VALENCIENNES (8), vol. 15, pp. 219-220; also p. 228.

With reference to one of these forms\* WEYENBERGH (40, pp. 91, 92), remarks that from its "ground" habitat and peculiar shape an air-bladder is unnecessary and consequently has entirely atrophied. WEYENBERGH'S statement that the air-bladder is absent in this species is certainly inaccurate, since the results of REISSNER'S investigations, which we are able to confirm, have demonstrated its existence in a rudimentary condition, but his remarks as to the uselessness of the organ in the light of the peculiar habits of the fish are worthy of note.

But although it is possible in the case of many Siluridæ abnormales to prove the association of a "ground" habit with the possession of a rudimentary air-bladder in the probable relation of cause and effect, there are a few genera in which this is much more difficult. *Bagarius*, *Silondia*, *Ailia*, *Eutropiichthys* and *Callomystax* are neither inhabitants of mountain streams or torrents, nor are they in any sense amphibious, but, on the contrary, frequent the larger rivers of the low country and plains of India, and beyond this we have not been able to obtain any precise information as to their habitat or mode of life. The non-utility of the air-bladder as a hydrostatic organ in several of these Siluroids is very obvious from its extremely small size, and notably in *Bagarius Yarrellii*, where each of the two air-sacs into which the bladder is divided was only equal to the size of a garden pea in a Fish weighing ten pounds. In all such instances as these we can only suggest that here, as in many other cases, it is highly probable that the rudimentary condition of the air-bladder will eventually be found to be correlated with a purely ground life. Hence, it may be concluded that in the case of many Siluridæ abnormales there is a certain amount of evidence which strongly favours the view that the degenerate condition of the air-bladder is directly caused by reversion to a "ground" life, and also that, by analogy, this is likewise true of the remaining species and genera where, from ignorance of their habits, no trustworthy evidence on this point can at present be obtained. If our contention should ultimately prove to be correct, it will furnish a strong argument in favour of the conclusion which, on other grounds, we have already arrived at, viz., that the Weberian mechanism is physiologically related to the normal hydrostatic function of the air-bladder, and not to audition, or to the perception of varying atmospheric pressures.

The susceptibility of the air-bladder to change of habitat on the part of its possessor is well shown by the variations which occur within the limits of the same genus. Two species of *Cryptopterus* (*C. micropus* and *C. hexapterus*) have rudimentary air-bladders, while all the remaining species of the genus that came under our notice had those organs unusually well-developed. The genus *Pimelodus* exhibits an even more interesting illustration of the influence of a change of habit on the condition of the air-bladder. In two species of this genus (*P. pulcher* and *P. sapo*) the air-bladder itself is not only rudimentary but lacks even a trace of the compressor and tensor tripodis muscles which are so characteristic of the normal Pimelodinæ.

\* *Hypostomus plecostomus*, CUV. et VAL. = *Plecostomus bicirrhosus*, GRONOV.

In the absence of any definite knowledge of the habits of these species no certain conclusions can be drawn as to the causes which have brought about the rudimentary state of the air-bladder, but the assumption of a "ground" habit may prove to be one of them.

The structural variations met with in the air-bladder of different Siluridæ abnormalities require, in many instances, no special explanation, and are readily explicable as being due to the more or less complete degeneration of parts of a useless organ, combined with the usual polymorphism of vestigial structures. Such features as the diminutive size of the air-bladder; the atrophy of the lateral compartments and the partial solidification of the reduced anterior chamber; the atrophy of the fibrous tracts by which the contraction or distension of the air-bladder becomes converted into corresponding movements of the Weberian ossicles; and the suppression of the ductus pneumaticus, can be easily understood as having arisen in this way. But there are nevertheless at least two features in connection with the air-bladder, which are somewhat difficult to explain. One is, its persistence even in a reduced condition, when as a useless organ its total suppression would seem to be the more natural result, and indeed is the only result so far as all other Teleostei are concerned, while the second difficulty is the partial or complete encapsulation of the vestigial air-bladder by bone. The following considerations may possibly throw some light on the first of these difficulties:—

The degeneration of an organ which, from change of habit, has become more or less useless to its possessor may be brought about by the single or conjoint operation of several causes. (1) The cessation of the preservative influence of natural selection, or what WEISMANN has termed "panmyxia," combined with what GALTON has called "regression towards mediocrity," so that the organ fails to be maintained at its previous high level of development. (2) Reduction in size and simplification in other respects of a useless organ may also be due to action of natural selection in view of the advantage which the animal derives from economy of nutrition. (3) The retention in its fully developed condition of an organ of no functional utility might entail some positive disadvantage to the animal when exposed to new conditions of life, in which case the operation of natural selection in more or less completely eliminating the useless structure would be certain and speedy. On the assumption of a "ground" habit by a Fish, the air-bladder would tend to become useless and, sooner or later, vestigial, and it is highly probable that the three factors mentioned above may all have co-operated in initiating this result. But like so many other vestigial structures, and especially those which result from the retrogressive modification of organs of great functional importance in a large series of animals, and therefore probably of great antiquity, the air-bladder, even when useless, often exhibits a singular vitality and persistence. The initial degeneration of the air-bladder in its useless condition may be accounted for, in part, by the advantage of economy of nutrition; but reduction in size beyond a certain limit can scarcely have been due to

this cause alone, for long before its total disappearance the nutritive requirements of the organ must become so infinitesimally small that no positive or obvious disadvantage could result from its retention in a diminutive condition. When extrinsic muscles in connection with the air-bladder become useless, economy of nutrition would, no doubt, soon lead to the total suppression of such highly vascular structures, and hence the complete atrophy of the compressor and tensor tripodis muscles of certain Pimelodinæ with rudimentary air-bladders is, on the contrary, easy to understand. Then again, while it is by no means difficult to see that the persistence of a fully developed air-bladder in purely "ground" Fishes might not only be useless, but even positively harmful, when the animal habitually rests on the bottom when not in motion by the exercise of its fins, it is at the same time difficult to appreciate the disadvantage of retaining an air-bladder so small as to be utterly without influence in its locomotor functions, or in any way capable of imparting undue buoyancy to the animal. Hence it seems to us, of the three causes tending to produce degeneration, the only ones likely to have much effect in reducing the air-bladder beyond a certain minimum size are "panmyxia" and "regression towards mediocrity," and it may therefore be conjectured that the antagonistic force of heredity has so far retarded the operation of these causes as to have secured the persistence of a small vestigial air-bladder in all existing Siluridæ abnormales. A difficulty in the way of this explanation of the invariable retention of a small vestigial and useless air-bladder in these Siluroids instead of its total suppression is the fact that in so many Teleostei, where the air-bladder has presumably become useless from some cause or other, the total disappearance of the organ follows almost as a matter of course. In certain families, Physostomi and Physoclisti, the air-bladder is totally absent. The Scopelidæ and Symbranchidæ are examples of this in the former group, and the Pleuronectidæ and Lophiidæ in the latter; and if the line of argument adopted above in the special case of the Siluridæ has any force, it would be reasonable to anticipate that it would also apply to the former, and that in these families a small vestigial, even if useless, air-bladder would be very generally present, which, as a matter of fact, is never the case. The suppression of an organ so physiologically important as the air-bladder in entire families of Teleostei is, of course, suggestive that the operation of causes tending to produce this result has probably extended over a far wider period of time than has been the case with genera or species only of those Siluroids in which merely a partial reduction has taken place, and that given sufficient time, and the accumulative action of such causes, the same ultimate result would be arrived at in the latter as in the former. But in opposition to this suggestion must be placed the fact that in certain Physoclist families (*e.g.*, Scombridæ and Polynemidæ) the air-bladder is absent in some species of the same genus while present in others. Thus, on the authority of DAY,\* it is stated that *Scomber colias* possesses an air-bladder, while *S. scomber* has none; similarly among the Asiatic species of *Polynemus*, *P. paradiseus*

\* "The Burbot (*Lota vulgaris*) and Air-Bladder of Fishes," 'Cotteswold Nat. Field Club,' 1880.

and *P. tetradactylus* are without air-bladders, while, on the contrary, such organs are present in *P. indicus* and *P. plebejus*. Such facts certainly seem to indicate that total suppression may take place so rapidly as to have become completed within the relatively limited time that has elapsed since certain of these Fishes acquired their present specific characters. Without attempting to assign relative values to the three causes which have probably brought about the total atrophy of the air-bladder in these instances, the evidence seems strongly in favour of the view that, either singly or conjointly, their operation is calculated to lead to the speedy and complete suppression of a useless air-bladder, and is distinctly adverse to the retention of that organ, however vestigial may be the condition to which it has been reduced; hence the persistence of a vestigial air-bladder in so many Siluridæ, in spite of causes which, in most other Fishes, have sufficed to secure its total atrophy, can hardly be explained by the suggestion previously made by us.

The widespread persistency of a vestigial and useless air-bladder seems to be peculiar to the Ostariophyseæ; in fact, we know of no species in any of the different families of the group in which an air-bladder is entirely wanting. On the contrary, so far as our knowledge extends, this fact is altogether without parallel in all the remaining families of Teleostei, in which total suppression seems invariably to follow loss of function. There are, however, two points in connection with the air-bladder of the Siluridæ abnormales that are not without some significance, and may possibly furnish an explanation of this anomaly. The first has reference to the method by which the reduction of the bladder has been effected. We have previously pointed out that the vestigial air-bladder in these Siluroids represents the anterior chamber only of the normally developed organ, and that the lateral compartments have almost always undergone total atrophy. The process of reduction has, therefore, not affected all parts of the air-bladder to an equal extent, and, while it has almost invariably led to the total suppression of all trace of lateral chambers, the anterior chamber has been allowed to persist in a reduced and vestigial condition; or in other words, while total atrophy has taken place with respect to that part of the bladder not specially related to the Weberian ossicles, that portion of it which alone is directly connected with those ossicles invariably persists. The second point relates to the persistence of the now useless Weberian ossicles. The uniform retention of a fairly complete series of ossicles in all Siluridæ abnormales is explicable as due to the absence of any potent cause for their speedy suppression. Economy of nutrition can have scarcely any effect in this direction, nor need the direct action of natural selection be invoked for the purpose, for, if useless, their persistence need not necessarily prove a source of disadvantage or harm to their possessor. Whatever trace of degeneration the mechanism presents may therefore be solely due to "panmyxia," or to "regression towards mediocrity," and these, as we have already conjectured, are causes that operate with extreme slowness. The conclusion suggested to us by these facts, and one which seems to offer a reasonable explanation of what would otherwise be a singular anomaly,

is this: that the curious and, in many respects, unique persistence of a useless air-bladder is due to its highly specialized connection with the Weberian mechanism. As is well known, comparative anatomy affords numerous examples of the persistence of functionless but harmless skeletal structures, which occasionally may even retain traces of their softer connections, and, in our opinion, it is the retention of the Weberian ossicles that has been the principal cause of the persistence of a useless air-bladder, in much the same way that the useless and rudimentary bones of the hind limbs of certain aquatic Mammalia sometimes retain remnants of their equally useless muscles and ligaments.

The second problem suggested, viz., the frequent encapsulation of the rudimentary air-bladder by bone in abnormal Siluridæ, is a very difficult one, and one which we must confess our inability to explain satisfactorily, or to do more than suggest possible solutions. Three points may be kept in view in discussing this question:— (1) That the degree of encapsulation generally bears some relation to the extent to which the air-bladder retains the structural integrity of its walls and its apparently normal connection with the tripodes;\* (2) that however defective in some respects the individual Weberian ossicles may be, the continuity of those that persist is complete in all Siluridæ abnormales; and (3) that encapsulation is strictly confined to the rudimentary air-bladders of the Ostariophyseæ, and occurs in no other living Teleostei.†

Partial encapsulation, to the extent that the reduced air-bladder occupies transversely disposed grooves or hollows on the ventral surfaces of the expanded and conjoined transverse processes of the fourth and fifth vertebræ, is, perhaps, not difficult to explain, for reduction in the size of the anterior chamber has simply been accompanied by a corresponding contraction and curvature of the modified transverse processes which normally closely invest and are adapted to the convexity of its dorsal and anterior surfaces. The difficulty is felt to be greater in the case of such Siluroids as *Cetopsis*, *Clarias*, *Callomystax*, *Acanthicus*, and the various Loricaroid genera, in which the diminutive air bladder is almost completely encapsuled by bone, and while obviously useless for all hydrostatic purposes, retains much of its structural integrity as well as its normal relations to the Weberian ossicles. In several of these genera, in addition to the share taken by the transverse processes, which of itself might be readily accounted for in the way suggested above, certain additional means are employed to ensure the more complete enclosure of the air-bladder within osseous capsules, and this at least suggests the possibility that some specific and useful object is to be gained thereby. Of these additional methods we may again refer to the partial ossification of the walls of the air-bladder itself (e.g., *Acanthicus*), and to the

\* See Morphological Summary, pp. 251, 252, and p. 259.

† According to WILLIAMSON (41) the air-bladder in certain fossil Ganoids has ossified walls. If it were possible it would be extremely interesting to ascertain if these fishes possessed any form of Weberian mechanism.

development of special bony laminæ (ventral processes) by the extension of bony deposit from the superficial ossifications investing the complex centrum with the superficial fibrous tissue which lies between the peritoneum and the ventral surface of the bladder. In such cases as these it may be conjectured that the retention of even a rudimentary air-bladder would be harmful to its owner if it were even imperfectly in physiological connection with the auditory organ through the Weberian ossicles, for even a purely "ground" Fish may be exposed to variations of hydrostatic pressure in the course of its migrations at different depths, or over the uneven bed of a river, or, as might be the case in some instances, where the Fish inhabited tidal rivers, by the rise or fall of the tide, and such variations might lead to the transmission of stimuli to the auditory organ, but no responsive adjustment on the part of the Fish could take place on account of the utter uselessness of the air-bladder for its normal hydrostatic function. Physiologically, the enclosure of the reduced air-bladder within a bony capsule would have the effect of preventing its expansion under the influence of diminished pressure, and conceivably therefore subserve the purpose of preventing the transmission of useless and disturbing stimuli to the central nervous system.

On the other hand, in several abnormal Siluroids (*e.g.*, *Bagarius*, *Akysis*, *Acrochordonichthys*, *Glyptosternum*, *Eucliptosternum*, &c.) the air-bladder has so far undergone retrogressive modification in one way or another as to have been structurally incapable of responding to variations of external pressure, or of initiating any movements in the chain of Weberian ossicles. In all these Siluroids the atrophy of the fibres forming the dorsal walls of the two lateral air-sacs constitutes a structural lesion so obvious that it is impossible that any alterations in the volume of the air-bladder could be converted into corresponding movements of the Weberian mechanism or in any way affect the auditory organ. In such instances complete encapsulation is, *ex hypothesi*, unnecessary, and therefore does not take place. As suggested above, the partial enclosure of the air-bladder within mere grooves or recesses on the ventral surfaces of the modified transverse processes may here be regarded as simply due to the fact that, as the organ lost its lateral compartments and the anterior chamber gradually became smaller, the transverse processes still continued to retain their normal relations to the latter, while at the same time contracting and more or less curving round it. On the other hand, there are one or two abnormal forms (*e.g.*, *Pimelodus pulcher* and *Schilbichthys*) in which encapsulation is but partial, although the structural integrity of the air-bladder is so far maintained that it might still be susceptible to slight volumetric changes when exposed to pressure variations, and also be able to convert such changes of volume into movements of the Weberian ossicles, but in these, and in one or two other similar cases, it will generally be found that the bladder is so far environed by bone that no lateral distension can take place. Thus in the types referred to the osseous grooves are contracted distally in such a way as to effectually check all tendency to lateral expansion on the part of the air-

bladder. In *Schilbichthys* it will be noted that even the stem and inferior limb of the post-temporal may co-operate in securing this result.

We have ventured to suggest this explanation in those cases where encapsulation is most complete, because at first sight it seems to be a legitimate inference from the three facts to which reference has just been made, but as an objection it may be urged that the same physiological result might have been gained by simpler and more natural means. Complete or partial atrophy of the air-bladder would even more effectually have prevented transmission of useless stimuli to the auditory organ, and would seem also to be the more natural as well as the more easily acquired safeguard. In some cases (*e.g.*, *Bagarius*, *Glyptosternum*, &c.) the latter method apparently is the one adopted for the purpose. But if our previous conclusion, that the useless air-bladder owes its singular persistence in these Siluroids to its connection with the Weberian ossicles, be correct, it may nevertheless have happened that in other cases reduction in the size of the air-bladder took place so slowly that encapsulation superseded complete atrophy as a means for securing the object in question. It must also be borne in mind that even in its normal condition the air-bladder and its connective tissue investment are frequently invaded by ossified deposit. The superficial ossification of the complex centrum and the ventral processes, the terminal plates of the "elastic-spring" apparatus, and the posterior extremities of the tripodes, are examples of this tendency. More or less complete encapsulation through an extension of this process may therefore have been more readily acquired than at first sight would seem possible or probable.

If it be objected that this view is somewhat far-fetched, an alternative explanation of the difficulty may be suggested. It is possible that encapsulation has really no physiological significance. Whatever share the modified transverse processes take in the process may be only due to their tendency to contract round and envelope an atrophying structure to an extensive portion of the surface of which they are always closely moulded, while the development of such additional means of encapsulation as the ossification of the walls of the air-bladder itself, or the growth of ventral processes, is due solely to an exaggeration of that tendency to ossification which is always obvious in the normal air-bladder when no longer checked in the useless organ by the controlling influence of natural selection.

It is interesting to observe that other families of Ostariophyseæ, and notably those Cyprinidæ included in the sub-group Cobitidinae, exhibit a parallel, and in many respects a substantially similar series of modifications. As WEBER (*loc. cit.*) first pointed out, the air-bladder of *Cobitis fossilis* is not only of relatively small size, but is also completely enclosed within a thin bony capsule of corresponding shape. Other Loach-like forms as, for example, *Nemachilus* and *Botia*, present the same peculiarity, and it is by no means improbable that a similarly modified air-bladder is present in all or most of the remaining genera of this section of the family. In the three genera mentioned above the degeneration and encapsulation of the air-bladder follow much



the same lines as in the Siluridæ abnormales. The series of Weberian ossicles is complete, including even an intercalarium; the anterior chamber of the typically bilocular Cyprinoid air-bladder, as a rule, alone persists, although in a much reduced condition; the posterior chamber, if present at all, is scarcely more than the barest rudiment; and it is the anterior alone which is encapsuled by bone. Furthermore, such characteristic modifications of the air-bladder are, in these genera, undoubtedly associated with a purely ground habit of life. *Nemachilus barbatula*, the commonest of English Cobitidæ, is unquestionably a ground Fish, its general habit being to lurk under stones at the bottom of rapidly-flowing streams, or, if nearer the surface, to rest on floating weeds. The popular names "Groundling" and "Stone Loach" sufficiently indicate the habits of this Fish. *Cobitis tania*, a much rarer English species, is also a "ground" Fish, but it is said to be partial to muddy bottoms. Of the East Indian genus *Botia*, DAY\* remarks that it "can scarcely be said to be entirely a ground feeder, but seems intermediate in habit between the true Carp and the grovelling Loaches." In the condition of its air-bladder *Botia* exhibits a similar gradation between the two types, for, while the anterior chamber is completely encapsuled by bone, the posterior chamber, though reduced in size, is still better developed than in *Cobitis* and *Nemachilus*.

So close a parallelism in the condition of the air-bladder and the habits of its possessor in two families so well defined and distinct, both in general characters and the structure of the air-bladder and Weberian mechanism, as the Cyprinidæ and Siluridæ, can only be due to the operation of similar causes in both instances, and in our opinion is strongly confirmatory of the conclusions we have already arrived at in the case of the latter family. But although the modifications which the air-bladder undergoes in the abnormal forms of both families are substantially similar in principle and in result, and have no doubt been evolved in each case to bring the organism into harmony with practically similar external conditions, there are certain minor differences between the two as to the precise means employed. Encapsulation of the air-bladder in the Cyprinidæ appears invariably to result from the actual ossification of the walls of the air-bladder itself, the modified transverse processes taking little, if any, share in the process. This may possibly be explained by the fact that in these Cyprinidæ with a normally-developed air-bladder, the transverse processes, though greatly developed in size and otherwise modified, are never so expanded or so closely moulded to the anterior and dorsal surfaces of the anterior chamber as is always the case in the normal Siluridæ, and hence, instead of encapsulation being effected, as is generally the case in the latter, by a slight extension of a modification already existing, it has been brought about in the former by the actual ossification of the outer coat of the air-bladder itself. The completeness of encapsulation in the Cyprinidæ we associate with the general integrity of the rest of the air-bladder and Weberian mechanism, for reasons previously urged in the case of certain Siluridæ.

\* 'Cotteswold Nat. Field Club,' 1880, p. 19.

abnormales. Further investigation may prove that a considerable number of Cyprinidæ besides the Cobitidinae possess reduced and bone-encapsuled air-bladders, more especially those hilly or Alpine genera, such as *Gymnocypris*, *Oreinus*, *Schizothorax*, *Ptychobarbus*, *Schizopygopsis*, *Diptychus*, and others, that certainly live under conditions in every respect very similar to those which in so many Siluridæ are associated with a degenerate bladder. The small East Indian Cyprinidæ which are included in the sub-group Homalopterina are usually described as entirely without an air-bladder. They are said to be exclusively ground forms, with the ventral surface of the body flattened for adhesion to stones at the bottom of the rapid hill and mountain streams to which they are restricted. The habits of these Fishes would certainly lead us to expect that the air-bladder would be rudimentary and enclosed within bony capsules, but its complete suppression is unique so far as the Ostariophyseæ are concerned. But in view of the fact that the very existence of an air-bladder has been denied in the case of several Siluroids which are now known to possess at least a vestige of that organ, the statement that it is completely absent in the Homalopterinae cannot be accepted without further confirmation.

#### VI.—CONCLUDING REMARKS.

The many and varied structural modifications met with in the air-bladder of the Siluridæ are not surprising in view of the exceptionally diversified conditions under which the different species and genera live. Their geographical distribution is almost co-extensive with the tropical and subtropical regions of the Earth's surface, and both the habitat and habits of the different species are remarkably varied. Some Alpine species are restricted to mountain streams often at an altitude of several thousands of feet above the sea level, and sometimes reaching a height of 15,000 feet, as is the case with certain Siluroids of the Andes of South America; other species are characteristic of the streams of the hilly country of a lower level; while other species again are equally characteristic of the larger rivers and lakes of the plains; and a limited few are marine, extending even to some of the Oceanic islands of the Pacific. The climatic variations to which the Siluridæ are subject are almost as diversified. Though mainly tropical or subtropical, certain genera are exposed to an almost Arctic climate, at least for a portion of the year, the result either of the altitude at which they live, or of their extension to the confines of the north temperate regions. The physical conditions under which many Siluridæ are capable of living are almost as varied as their geographical distribution or climatic range. Many of them are ground-feeders; some of them have a remarkable power of living out of water; others are liable through prolonged drought and the consequent drying up of rivers or lakes to become buried in the mud for longer or shorter periods without subsequent injury; and others again are said to be capable of migration upon land from river to river.

DARWIN\* has pointed out, in referring to the conditions favourable to variation in

\* 'The Origin of Species,' 6th ed., pp. 42 to 43.

animals and plants, that it is common, widely-diffused and widely-ranging species that vary most, and that this might be expected from the diverse physical conditions to which they are exposed, as well as from differences in the nature and quality of their living competitors in different regions. Elsewhere\* he likewise alludes to the fact that an organ developed in an extraordinary manner implies that it is of high functional importance to the species, and that it may also be concluded that the organ has undergone a great amount of variation since it first came into existence. It is clear that the Siluridæ furnish an admirable illustration of the truth of these remarks. Their extensive geographical distribution and highly varied habitat, their richness alike in individuals and species, and, in short, their dominant position in fresh waters over wide areas, are quite sufficient to account for almost infinite variation. On the other hand, in the air-bladder and Weberian mechanism combined we have an organ, which, from its highly specialized and remarkable development, must be of great functional importance to these Fishes. Hence, the extraordinary variations which this organ and its correlated skeletal structures present need occasion no surprise when it is obvious that we have in the character of the organ itself, and in the external environment of the family in which it is most highly specialized, all the conditions necessary for the action of natural selection in producing rapid and extensive modification, either in the progressive or retrogressive direction. Under such conditions adequate scope would be afforded for the operation of natural selection in perfecting the useful organ and eliminating by atrophy and degeneration the useless one. Nor is it difficult to see how it is that the Weberian apparatus and air-bladder are more specialized in the Siluridæ than in other Ostariophyseæ. The only rivals to the Siluridæ in the extent of their geographical distribution are the Cyprinidæ, for the remaining families have but a comparatively restricted range. But extensive as is their geographical distribution, the great majority of the Cyprinidæ appear to exist under fairly uniform conditions, or, at all events, exhibit nothing like the diversity of habitat and habits that is so characteristic of the Siluridæ, and hence it is that so far as the structure of the air-bladder and Weberian mechanism is known in the former family, it presents but little variation in the direction of increased specialization, although in a few genera the effects of degeneration are sufficiently obvious.

#### VII.—SYSTEMATIC INDEX.

In this Index we have adhered to Dr. GÜNTHER'S classification and order of enumeration, as set forth in his "Catalogue of the Fishes in the British Museum," vol. 5, 1864, p. xi. Species referred to by us which are not in that Catalogue are added at the end of the list of species belonging to that particular genus. The pages where any species is described in detail are indicated by the use of a heavier type.

\* *Ibid.*, p. 119.

## SILURIDÆ.

## First Sub-family. SILURIDÆ HOMALOPTERÆ.

## First Group. CLARIINA.

*Clarias*, GRONOV.*anguillaris*, L., 188, 195.*macracanthus*, GTHR., 195.*magur*, HAM. BUCH., 187, 188, 195, 305.*fuscus*, LACÉP., 188, 195.*Nieuhofii*, C. et V., 187–195, 199.*hasselquistii*, C. et V., 187.*Macropteronotus magur* (cf. *Clarias*).*Heterobranchus*, GEOFFR., 195.

## Second Group. PLOTOSINA.

*Plotosus*, LACÉP.*anguillaris*, BL., 197, 198.*canius*, HAM. BUCH., 195–197, 198, 201.*Copidoglanis*, GTHR.*albilabris*, C. et V., 198.*Cnidoglanis*, GTHR.*megastoma*, RICHARDS, 198, 201.

## Third Group. CHACINA.

*Chaca*, C. et V.*lophioides*, C. et V., 199.

## Second Sub-family. SILURIDÆ HETEROPTERÆ.

## Fourth Group. SILURINA.

*Saccobranchus*, C. et V.*fossilis*, BL., 199, 200.*Silurus*, ARTEDI.*glanis*, L., 66, 100, 200, 201, 226, 233, 282.*cochinchinensis*, C. et V., 201.*Wallago*, BLKR.*attu*, SCHN., 201.*Eutropiichthys*, BLKR.*vacha*, HAM. BUCH., 201, 202.

*Cryptopterus*, GTHR.

- limpok*, BLKR., 203, 213.  
*palembangensis*, BLKR., 203.  
*bicirrhis*, C. et V., 203.  
*micropus*, BLKR., 202, 204, 205, 211, 249, 306.  
*micronema*, BLKR., 202, 203, 235.  
*hexapterus*, BLKR., 202, 204, 205, 249, 306.  
*micropogon*, BLKR., 203, 235.

*Callichrous*, GTHR.

- bimaculatus*, BL., 207.  
*ceylonensis*, GTHR., 202, 206, 207.  
*pabo*, HAM. BUCH., 207.  
*hypophthalmus*, BLKR., 207.

*Schilbe*, BLKR.

- mystus*, C. et V., 207, 208.

*Eutropius*, MÜLL. et TROSCH.

- niloticus*, RÜPP., 208.  
*murius* (cf. *Pseudeutropius*).

*Ailia*, C. et V.

- bengalensis*, GRAY, 208–211.

*Schilbichthys*, BLKR.

- garua*, HAM. BUCH., 202, 211–213, 214 (cf. *Pseudeutropius*).

*Lais*, BLKR.

- hexanema*, BLKR., 213, 214.

*Pseudeutropius*, BLKR.

- atherinoides*, BL., 214.  
*goongwaree*, SYKES, 214.  
*murius*, HAM. BUCH., 214 (cf. *Eutropius*).  
*garua* (cf. *Schilbichthys*).

*Pangasius*, C. et V.

- Buchanani*, C. et V., 167, 214–218, 219, 234, 235, 243, 244.  
*djambal*, BLKR., 167, 214, 219, 235, 243, 244.  
*macronema*, BLKR., 219, 220, 221, 235, 243, 244.  
*micronema*, BLKR., 220, 221, 244.  
*juaro*, BLKR., 221, 243, 244.

*Silondia*, C. et V.

- gangetica*, C. et V., 221–223.

## Third Sub-family. SILURIDÆ ANOMALOPTERÆ.

## Fifth Group. HYPOPTHALMINA.

*Hypophthalmus*, C. et V.*marginatus*, C. et V., 176-178.

## Fourth Sub-family. SILURIDÆ PROTEROPTERÆ.

## Sixth Group. BAGRINA.

*Bagrus*, BLKR.*bayad*, FORSK., 102.*docmac*, FORSK., 102.*(Sciades) emphysetus*, M. et T. (cf. *Arius*).*Chrysichthys*, GTHR.*macrops*, GTHR., 102.*Macrones*, DUM.*nigriceps*, C. et V., 100.*aor*, HAM. BUCH., 76, 101, 102, 103, 232, 235, 237, 243.*gulio*, HAM. BUCH., 100.*nemurus*, C. et V., 63, 100, 101, 102, 103, 104, 106, 218, 240, 268, 275.*Hoevenii*, BLKR., 100, 101, 104.*planiceps*, K. et v. H., 100.*tengara*, HAM. BUCH., 100.*Wolffi*, BLKR., 100.*armatus*, DAY (*M. vittatus*, BLKR.), 100.*Pseudobagrus*, BLKR.*fulvi-draco*, RICHARDS, 103.*brachysoma*, GTHR., 102, 103, 105, 112.*Liocassis*, BLKR.*micropogon*, BLKR., 103, 104.*Bagroides*, BLKR.*melanopterus*, BLKR., 103, 104, 105, 235.*Rita*, BLKR.*crucigera*, OWEN, 105-107.*Acrochordonichthys*, BLKR.*pleurostigma*, BLKR., 107, 110-112.*Akysis*, BLKR.*variegatus*, BLKR., 107-110.*Kurzii*, DAY, 110.

*Olyra*, M'CLELL.

*burmanica*, DAY, 112.

*Amiurus*, GTHR.

*catus*, L., 66, 69, 78, 80, 98, 100, 130, 112, 224, 233, 260, 267, 275.

Seventh Group. PIMELODINA.

*Sorubim*, BLKR.

*lima*, SCHN., 118.

*Platystoma*, AGASS.

*fasciatum*, L., 118, 125, 135, 246.

*tigrinum*, C. et V., 113-118, 135, 243, 246.

*coruscans*, AGASS., 118, 246.

*Piramutana*, GTHR.

*piramuta*, KNER., 118, 119, 243.

*Blochii*, C. et V., 119.

*Pseudarioides clarias*, BL. (cf. *Piramutana Blochii*).

*Piratinga*, GTHR.

*filamentosa*, LICHT., 119, 246.

*Pimelodus*, GTHR.

*maculatus*, LACÉP., 119, 120, 243.

*ornatus*, KNER., 120, 243.

*sapo*, VAL., 123-125, 247, 248, 249, 253, 306.

*pulcher*, BOUL., 121-123, 248, 250, 253, 306, 311.

*pangasius*, HAM. BUCH. (cf. *Pangasius Buchananii*).

*platypogon*, K. et v. H. (cf. *Glyptosternum*).

*filamentosa*, LICHT. (cf. *Piratinga*).

*macropterus*, LICHT. (cf. *Callophysus*).

*Callophysus*, M. et T.

*macropterus*, LICHT., 125.

*Auchenoglanis*, GTHR. (*Auchenaspis*, BLKR.)

*biscutatus*, GEOFFR., 88, 125-127.

Eighth Group. ARIINA.

*Arius*, GTHR.

*thalassinus*, RÜPP., 137.

*sagor*, HAM. BUCH., 137, 138.

*arioides*, C. et V., 137.

*assimilis*, GTHR., 137, 138.

*emphysetus*, M. et T., 139, 246.

*laticutatus*, GTHR., 137, 138.

- Milberti*, C. et V., 138, 246.  
*truncatus*, C. et V., 137.  
*calatus*, C. et V., 137, 138, 246.  
*venosus*, C. et V., 137, 138.  
*utik*, BLKR., 137.  
*argyroleuron*, K. et v. H., 137.  
*maculatus*, THUNB., 137.  
*pidada*, BLKR., 128-137, 139, 140, 141, 143, 154.  
*gagora*, HAM. BUCH., 138, 139.  
*australis*, 137, 138.  
*Hemipimelodus*, BLKR.  
     *borneensis*, BLKR., 139, 140.  
     (*cenia*, HAM. BUCH., 140, = *Callomystax* sp.).  
     (*viridescens*, HAM. BUCH., 140, = *Callomystax* sp.).  
*Galeichthys Gronovii* (cf. *Ælurichthys*).  
*Ketengus*, BLKR.  
     *typus*, BLKR., 140.  
*Ælurichthys*, BAIRD et GIR.  
     *longispinis*, GTHR., 140, 141, 246.  
     *Gronovii*, C. et V., 140, 141, 246.  
*Osteogeniosus*, BLKR.  
     *militaris*, L., 143.  
     *Valenciennesii*, BLKR., 141-143.  
     *macrocephalus*, BLKR., 143.  
*Batrachocephalus*, BLKR.  
     *mino*, HAM. BUCH., 133, 141.

## Ninth Group. BAGARINA.

- Bagarius*, BLKR.  
     *Yarrellii*, SYKES, 143-147, 187, 190, 306.  
*Euclyptosternum*, GTHR.  
     sp. ? 155.  
*Glyptosternum*, GTHR.  
     *platypogon*, K. et v. H., 147-155.  
     *telchitta*, HAM. BUCH., 147.  
     *conirostris*, STEINDACH, 155.  
*Hara*, BLYTH.  
     *Buchanani*, BLYTH, 155.  
*Amblyceps*, BLYTH.  
     sp. ? 156.



## Fifth Sub-family. SILURIDÆ STENOBRANCHIÆ.

## Tenth Group. DORADINA.

*Ageniosus*, LACÉP.*militaris*, BL., 156, 253, 259.*Eucnemus*, M. et T.*nuchalis*, SPIX, 162, 163.*Auchenipterus*, C. et V.*nodosus*, BL., 156-162, 165, 264.*obscurus*, GTHR., 162, 236, 264.*Cetopsis*, AGASS.*candira*, AGASS, 163, 164.*Doras*, GTHR.*maculatus*, VAL. (? *muricus*, KNER.), 164, 165, 246.*Oxydoras*, GTHR.*brevis*, HECK., 165, 166, 244.*Synodontis*, C. et V.*Schal*, SCHN., 166-168.

## Eleventh Group. RHINOGLANINA.

*Callomystax*, GTHR.*gagata*, HAM. BUCH., 168-173, 139, 140.

## Twelfth Group. MALAPTERURINA.

*Malapterurus*, LACÉP.*electricus*, GM., 173-176, 235.*beninensis*, MURRAY, 176.

## Sixth Sub-family. SILURIDÆ PROTEROPODES.

## Thirteenth Group. HYPOSTOMATINA.

*Callichthys*, L.*asper*, Q. et G., 183.*littoralis*, HANCOCK, 178, 183.*Plecostomus*, GTHR. (*Hypostomus*, LACÉP.).*verres*, C. et V., 178, 183.*Acanthicus*, SPIX ("Rhinelepis").*hystrix*, SPIX, 178-180, 181, 182, 183.

*Loricaria*, L.

*cataphracta*, L., 178, 180-182.

*nudirostris*, KNER, 180-182.

*Sisor*, HAM. BUCH., 183.

*Pseudecheneis*, BLYTH, 183.

*Exostoma*, BLYTH.

*Blythii*, DAY, 184.

Fourteenth Group. ASPREDININA.

*Aspredo*, L.

*batrachus*, L. (*lævis*, BL.), 184.

*cotylophorus*, BL., 184-187.

VIII.--REFERENCES.

1. BAUDELLOT, E.—“De la détermination des pièces osseuses qui se trouvent en rapport avec les premières vertèbres chez les Cyprins, les Loches et les Silures.” ‘Comptes Rendus,’ vol. 66, 1868, p. 330.
2. BIOT.—‘Mémoires de la Société d’Arcueil,’ vol. 1, 1807.
3. BORELLI.—‘De motu animalium,’ Romæ, 1680; and Lugduni Batavorum, 1685.
4. BRIDGE, T. W.—“The Air-bladder in certain Siluroid Fishes.” ‘Birmingham Phil. Soc. Proc.’ vol. 6, 1888, p. 131.
5. BRIDGE and HADDON.—“Contributions to the Anatomy of Fishes, (I.) the Air-bladder and Weberian Ossicles in the Siluridæ.” ‘Roy. Soc. Proc.’ vol. 46, 1889, p. 309; (II.) *Ibid.*, vol. 52, 1892, p. 139.
6. CHARBONNEL-SALLE.—“Sur les fonctions hydrostatiques de la vessie natatoire.” ‘Comptes Rendus,’ vol. 104, 1887, p. 1330.
- 6A. CLELAND, J.—“On the Skeleton, Muscles, and Viscera of *Malapterurus beninensis*.” ‘Edinb. New Phil. Journ.’ vol. 8 (N.S.), 1858, p. 177.
7. COPE, E. D.—“Observations on the Systematic Relations of the Fishes.” ‘American Naturalist,’ 1871, p. 579; and ‘Trans. Amer. Phil. Soc.’ vol. 14, 1871, p. 445.
8. CUVIER et VALENCIENNES.—‘Histoire naturelle des Poissons,’ 1828-1845, vol. 14, 1839; vol. 15, 1840.
9. DAY, FRANCIS.—“On the Freshwater Siluroids of India and Burmah.” ‘Zool. Soc. Proc.’ (London), 1871, p. 703.
10. ——— “Notes on Indian Siluroid Fishes.” ‘Zool. Soc. Proc.’ (London), 1871, p. 286.
- 10A. ——— ‘The Fishes of Great Britain and Ireland,’ 1880-84, vol. 2.
11. DELAGE, YVES.—“Sur une fonction nouvelle des otocystes comme organe d’orientation locomotrice.” ‘Archives Zool. expér. et gén.’ 2 Sér., vol. 5, 1887. See also abstract in ‘Journ. Roy. Microsc. Soc.’ 1887, pp. 52, 732.

- 11A. DELAROCHE, F.—“Observations sur la vessie aérienne des Poissons.” ‘Ann. du Mus. d’histoire naturelle,’ vol. 14, 1809, p. 180.
- 11B. DUFOSSÉ.—“Recherches sur les bruits et les sons expressifs que font entendre les Poissons d’Europe, et sur les organes producteurs de ces phénomènes acoustiques.” ‘Ann. des Sci. Nat. (Zool.),’ vol. 19, Art. No. 5, 1874.
12. ENGELMANN, W.—“Über die Function der Otolithen.” ‘Zool. Anzeig.,’ vol. 10, 1887, p. 439; abstract in the ‘Journ. Roy. Microsc. Soc.,’ 1887, p. 938.
13. GILL, T.—“Arrangement of the families of Fishes.” ‘Smithsonian Miscellaneous Collections,’ vol. 11, 1872.
- 13A. GOURIET, É.—“Du rôle de la vessie natatoire.” ‘Ann. des Sci. Nat. (Zool.),’ vol. 6, 1866, p. 369.
14. GÜNTHER, A.—‘Introduction to the Study of Fishes,’ Edinburgh, 1880.
15. ——— ‘Catalogue of the Fishes in the British Museum,’ vol. 5, 1864.
16. ——— “Ichthyology.” ‘Encycl. Britann.,’ ed. IX., vol. 12, 1881, p. 630.
17. GRASSI, B.—“Beiträge zur näheren Kenntniss der Entwicklung der Wirbelsäule der Teleostier.” ‘Morphol. Jahrb.,’ vol. 8, 1883, p. 457.
- 17A. HADDON, A. C.—“On the Stridulating Apparatus of *Callomystax gagata*.” ‘Journ. Anat. Phys.,’ vol. 15, 1881, p. 322.
18. HASSE, C.—“Beobachtungen über die Schwimmblase der Fische.” ‘Anatomische Studien,’ vol. 1, 1873, p. 583.
19. ——— “Das Gehörorgan der Fische.” ‘Anatomische Studien,’ vol. 1, 1873, p. 417.
20. JOBERT.—Quoted in SEMPER’s ‘Animal Life,’ (34, p. 444.).
21. KNER, R.—“Einiges über die Thymusdrüse bei Fischen und die Schwimmblase der Stachelflosser. ‘Sitz. Math.-Nat. Classe, Akad. Wissen., Wien,’ vol. 49, 1864; p. 455.
22. LEYDIG.—‘Lehrbuch der Histologie des Menschen und der Thiere,’ Frankfurt, 1857.
23. MCKENZIE, T., WRIGHT, R. RAMSAY, McMURRICH, J. P., and MACULLUM, A. B. (43).
24. MACULLUM, A. B., WRIGHT, R. RAMSAY, McMURRICH, J. P., and MCKENZIE, T. (43).
25. MILNE-EDWARDS, H.—‘Leçons sur la Physiologie.’ 1856–1862.
26. MONOYER.—“Recherches expérimentales sur l’équilibre et la locomotion chez les Poissons.” ‘Ann. des Sci. Nat.’ (Zool.), vol. 6, 1866, p. 5.
27. MOREAU, A.—“Recherches expérimentales sur les fonctions de la vessie nataoire.” ‘Ann. des Sci. Nat.’ (Zool.), vol. 4 (No. 8), 1876.
- 27A. ——— “Sur la voix des Poissons.” ‘Comptes Rendus,’ vol. 59, 1864, p. 436.
28. MÜLLER, JOHANNES.—“Untersuchungen über die Eingeweide der Fische. (iii.) Beobachtungen über die Schwimmblase der Fische.” ‘Abhandl. Akad. Berlin,’ 1843 [1845], p. 135. Previously published in abstract in ‘Monatsbericht Akad. Berlin,’ 1842, and ‘Archiv für Anat. und Phys.,’ 1842, p. 306.
- 28A. MURRAY, A.—“Remarks on the Natural History of Electric Fishes, with the

- description of a new species of *Malapterurus* from the Old Calabar River, West Africa." 'Edin. New Phil. Jour.' (N.S.), vol. 2, 1855, p. 35.
29. NUSBAUM, J.—"Ueber das anatomische Verhältniss zwischen dem Gehörorgane und der Schwimmblase bei den Cyprinoiden." 'Zool. Anzeig.,' vol. 4, 1881, p. 552.
30. OWEN, R.—"On the Anatomy of Vertebrates," vol. 1. 'Fishes and Reptiles.' 1866.
31. PARKER, T. J.—"On the connection of the air-bladder and the auditory organ in the Red Cod (*Lotella bacchus*)." 'Trans. New Zealand Institute,' vol. 15, 1882, p. 234.
32. REISSNER.—"Ueber die Schwimmblase und den Gehörapparat einiger Siluroiden." 'Archiv. für Anatomie, Phys., und wiss. Medicin.' Leipzig, 1859, p. 421.
33. SAGEMEHL, M.—"Beiträge zur vergleichenden Anatomie der Fische. (iii.) Das Cranium der Characiniden nebst allgemeinen Bemerkungen über die mit einem Weber'schen Apparat versehenen Physostomenfamilien," 'Morphol. Jahrb.,' vol. 10, 1885, p. 1.
34. SEMPER, K.—"The Natural Conditions of Existence as they affect Animal Life." 'Internat. Scientific Series,' 1881.
35. ST. HILAIRE, G.—"Description de l'Égypte" (2), vol. 24.
36. SÖRENSEN, W.—'Om Lydorganer hos Fiske.' (Dissertation for Doctor's Degree.) Copenhagen, 1884.
37. ——— 'Om Forbeninger i Svømmeblæren, Pleura og Aortas Væg og Sammensmeltung deraf med Hvirvelsøjlen særlig hos Siluroiderne samt de saakaldte Weberske Knoglers Morfologi.' 'Vidensk. Selsk. Skr., 6 Række, naturvidensk. og mathemat. Afd.,' VII. 2. Copenhagen, 1890, p. 67.
38. TAYLOR, J.—"On the Respiratory Organs and Air-bladder of certain Fishes of the Ganges." 'Edinburgh Journ. Science' (N.S.), vol. 5, 1831, p. 33.
39. WEBER, E. H.—"De aure et auditu hominis et animalium." Pars i. 'De aure animalium aquatiliium.' Leipzig, 1820.
40. WEYENBERGH, H.—"*Hypostomus plecostomus*, Val. Mémoire anatomique pour servir à l'histoire naturelle des Loricaires." Cordoba, 1876.
41. WILLIAMSON, W. C.—"On the Microscopic Structure of the Scales and Dermal Teeth of some Ganoid and Placoid Fish." 'Phil. Trans.,' 1849, p. 435.
42. WRIGHT, R. RAMSAY.—"The Relationship between the Air-bladder and Auditory Organ in *Amiurus*." 'Zool. Anzeig.,' vol. 7, 1884, p. 248.
43. ———, McMURRICH, J. P., MACULLUM, A. B., and MCKENZIE, T.—"Contributions to the Anatomy of *Amiurus*." Toronto, 1884. Reprinted from 'Proc. Canadian Institute' (N.S.), vol. 2, 1884, p. 251.
44. ——— "On the Skull and Auditory Organ of the Siluroid *Hypophthalmus*." 'Canada, Roy. Soc. Trans.,' vol. 3, sect. iv., 1885, p. 107.

## IX.—DESCRIPTION OF THE PLATES.

(Unless stated otherwise the Figures are of natural size. Figures relating to any species are not necessarily all drawn from the same specimen.)

## PLATE XI.

Figs. 1-6 and 8-24.—*Macrones nemurus*.

- Fig. 1. Lateral view of the skull and anterior vertebræ.  
 Fig. 2. Vertical longitudinal section.  
 Fig. 3. Ventral view of hinder part of skull and the anterior vertebræ ;  
     × 2.  
 Fig. 4. Lateral view ; × 3.  
 Fig. 5. Vertical longitudinal section of the hinder part of the skull, and of  
     the first and complex vertebræ ; × 3.  
 Fig. 6. Posterior face of the skull and the post-temporal of the left side ;  
     × 1½.  
 Fig. 7. Transverse section through the occipital region of the skull of  
     *Macrones aor* ; × 2.  
 Fig. 8. View of the cranial floor and auditory capsules, the roof of the skull  
     having been removed ; × 3.  
 Fig. 9. A similar view, but with the membranous labyrinth *in situ*, so as  
     to show the relations of the latter to the Weberian ossicles ;  
     semi-diagrammatic ; × 4.  
 Fig. 10. The Weberian ossicles ; external lateral view , × 3.  
 Fig. 11. The scaphium ; internal view ; × 3.  
 Fig. 12. The Weberian ossicles ; ventral view ; × 3.  
 Fig. 13. The tripus ; dorsal view ; × 3.  
 Fig. 14. The tripus ; ventral view ; × 3.

## PLATE XII.

- Fig. 15. Lateral view of the head and anterior portion of the trunk.  
 Fig. 16. Lateral view of the head and anterior portion of the trunk, after  
     the removal of the external skin on the right side.  
 Fig. 17. Ventral view of the air-bladder *in situ* ; × 2.  
 Fig. 18. Ventral view of the air-bladder *in situ* ; after the removal of its  
     ventral wall ; × 2.  
 Fig. 19. The dorsal and lateral walls of the air-bladder, showing the arrange-  
     ment of the fibres forming the outer and inner strata of the  
     tunica externa ; their relations to the tripodes, and the anterior

and posterior pillars of the anterior chamber; semi-diagrammatic;  $\times 2$ .

Fig. 20. Similar view of part of the dorsal wall of the anterior chamber;  $\times 4$ .

Fig. 21. Weberian ossicles; ventral view, showing the attachment of the fibres of the inner stratum of the tunica externa to the left tripus, and also the radial fibres;  $\times 3$ .

Fig. 22. Similar view of the attachment of the fibres of the outer stratum;  $\times 3$ .

Fig. 23. Transverse section through the body in the region of the anterior chamber of the air-bladder; semi-diagrammatic.

Fig. 24. Diagrammatic representation of the relations of the auditory organ, the cavum sinus imparis, and the atrial cavities to the Weberian ossicles and air-bladder.

Fig. 25.—*Macrones aor.* View of the posterior face of the skull with the post-temporals *in situ*.

#### PLATE XIII.

Fig. 26.—*Pseudobagrus brachysoma.* Ventral view of the anterior vertebræ and the modified transverse processes.

Fig. 27.—*Rita crucigera.* Ventral view of the cavity of the air-bladder.

Fig. 28.—*Acrochordonichthys pleurostigma.* Base of the skull, and the modified anterior vertebræ; ventral view;  $\times 3$ .

Figs. 29 and 30.—*Akysis variegatus.*

Fig. 29. Base of the skull, and the anterior vertebræ; ventral view;  $\times 2$ .

Fig. 30. Ventral view of the air-sacs *in situ*;  $\times 3$ .

Figs. 31–34.—*Platystoma tigrinum.*

Fig. 31. Vertical longitudinal section through the anterior vertebræ;  $\frac{1}{2}$  nat. size.

Fig. 32. Ventral view of the left halves of the anterior vertebræ and their processes;  $\frac{1}{2}$  nat. size.

Fig. 33. Ventral view of the air-bladder *in situ*.

Fig. 34. Interior of the air-bladder; ventral view.

#### PLATE XIV.

Fig. 35.—*Piramutana piramuta.* Ventral view of the base of the skull and of the anterior vertebræ; the interior of the right half of the bladder is also shown;  $\times 2$ .

Fig. 36.—*Pimelodus ornatus.* Interior of the air-bladder; ventral view;  $\times 2$ .

Figs. 37, 38.—*Pimelodus sapo*.

Fig. 37. Ventral view of the right half of the bladder and the left osseous capsule; the ventral part of the right capsule has been removed;  $\times 1\frac{1}{2}$ .

Fig. 38. The left tripus; ventral view;  $\times 3$ .

Figs. 39–41.—*Pimelodus pulcher*.

Fig. 39. Base of the skull, the right air-sac, the left osseous capsule, and the modified anterior vertebræ;  $\times 2$ .

Fig. 40. Ventral view of the interior of the two air-sacs;  $\times 2$ .

Fig. 41. Ventral view of the left tripus;  $\times 2$ .

Figs. 42–44.—*Auchenoglanis biscutatus*.

Fig. 42. Ventral view of the right halves of the anterior vertebræ and their processes.

Fig. 43. The left tripus; ventral view.

Fig. 44. Ventral view of the interior of the air-bladder.

Figs. 45–49.—*Arius pidada*.

Fig. 45. Lateral view of the hinder part of the skull and the anterior vertebræ.

#### PLATE XV.

Fig. 46. Vertical longitudinal section of the hinder part of the skull and the anterior vertebræ.

Fig. 47. The base of the skull and the anterior vertebræ; ventral view.

Fig. 48. Interior of the air-bladder; ventral view.

Fig. 49. The Weberian ossicles.

Fig. 50.—*Ketengus typus*. Lateral view of the interior of the air-bladder, the right outer wall having been removed.

Fig. 51.—*Osteogeniosus Valenciennesii*. Ventral view of the interior of the air-bladder.

Fig. 52.—*Batrachocephalus mino*. Interior of the air-bladder; ventral view.

Figs. 53, 54.—*Bagarius Yarrellii*.

Fig. 53. The base of the skull, the anterior vertebræ, the right air-sac, and the left osseous capsule. The stem and ascending process of the post temporal have been removed;  $\times 2$ .

Fig. 54. The left tripus;  $\times 2$ .

#### PLATE XVI.

Figs. 55–58.—*Glyptosternum platypogon*.

Fig. 55. The base of the skull, the anterior vertebræ, and the bony capsules for the air-sacs; ventral view;  $\times 2$ .

Fig. 56. Lateral view of the hinder part of the skull, the pectoral girdle, and the neural spines of the anterior vertebræ;  $\times 2$ .

- Fig. 57. Ventral view of the two air-sacs, showing their relations to the osseous capsules;  $\times 2$ .
- Fig. 58. The right tripus;  $\times 2$ .
- Figs. 59–63.—*Auchenipterus nodosus*.
- Fig. 59. Ventral view of the anterior vertebræ and the “elastic-spring” apparatus.
- Fig. 60. Similar view of the interior of the air-bladder.
- Fig. 61. Lateral view of the air-bladder and skull, showing the left protractor muscle of the mechanism.
- Fig. 62. Ventral view of the right tripus.
- Fig. 63. Dorsal view.
- Figs. 64–66. *Oxydoras brevis*.
- Fig. 64. Ventral view of the anterior vertebræ and the “elastic-spring” mechanism;  $\times 2$ .
- Fig. 65. The left tripus; ventral view;  $\times 2$ .
- Fig. 66. Ventral view of the interior of the air-bladder;  $\times 1\frac{1}{2}$ .
- Fig. 67.—*Synodontis schal*. Ventral view of the anterior vertebræ and the “elastic-spring” apparatus.
- Figs. 68–70.—*Callomystax gagata*.
- Fig. 68. Side view of the anterior vertebræ, showing the left osseous capsule and its air-sac, the lateral cutaneous area of that side having been removed;  $\times 2$ .
- Fig. 69. Lateral view of the anterior portion of the trunk.

## PLATE XVII.

- Fig. 70. Ventral view of the osseous capsules and their contained air-sacs;  $\times 2$ .
- Figs. 71, 72.—*Malapterurus electricus*.
- Fig. 71. Interior of the air-bladder; ventral view.
- Fig. 72. Side view of the hinder part of the skull and the anterior vertebræ, showing the left elastic-spring and its protractor muscle.
- Figs. 73–77. *Aspredo cotylophorus*.
- Fig. 73. Base of the skull and the anterior vertebræ; ventral view.
- Fig. 74. Vertical longitudinal section of the hinder part of the skull and the anterior vertebræ;  $\times 2$ .
- Fig. 75. Lateral view of the hinder part of the skull, the pectoral girdle, and the first, the complex, and the fifth vertebræ;  $\times 2$ .
- Fig. 76. Ventral view of the two air-sacs *in situ*.
- Fig. 77. Ventral view of the interior of the two air-sacs.



Figs. 78–81.—*Clarias Nieuhofii*.

Fig. 78. The base of the skull, the anterior vertebræ, and the two osseous capsules;  $\times 2$ .

Fig. 79. Vertical longitudinal section of the hinder part of the skull and the anterior vertebræ;  $\times 2$ .

### PLATE XVIII.

Fig. 80. Ventral view of the two air-sacs *in situ*.

Fig. 81. Ventral view of the interior of the right air-sac, showing the fibres of the dorsal wall and their relations to the tripodes;  $\times 2$ .

Figs. 82, 83.—*Plotosus canius*.

Fig. 82. Ventral view of the anterior vertebræ and the tripodes;  $\times 1\frac{1}{2}$ .

Fig. 83. Interior of the air-bladder; ventral view;  $\times 2$ .

Fig. 83A.—*Saccobranchus fossilis*. Ventral view of tripus;  $\times 1\frac{1}{2}$ .

Fig. 84.—*Silurus glanis*. Interior of the air-bladder; ventral view;  $\times 1\frac{1}{2}$ .

Fig. 85.—*Eutropiichthys vacha*. The base of the skull, the bony capsules, and the anterior vertebræ;  $\times 2$ .

Fig. 86.—*Cryptopterus hexapterus*. Ventral view of the anterior vertebræ and their processes;  $\times 2$ .

### PLATE XIX.

Figs. 87, 88.—*Ailia bengalensis*.

Fig. 87. The base of the skull and the osseous recesses for the tubiform air-bladder; ventral view;  $\times 3$ .

Fig. 88. Lateral view;  $\times 3$ .

Fig. 89.—*Schilbichthys garua*. Ventral view of the base of the skull, the right osseous capsule, and the interior of the left half of the air-bladder;  $\times 2$ .

Figs. 90, 93, 94.—*Pangasius djambal*.

Fig. 90. Ventral view of the left halves of the anterior vertebræ, and the left "elastic-spring."

Fig. 93. Interior of the air-bladder; ventral view.

Fig. 94. The right tripus; ventral view.

Figs. 91, 92.—*Pangasius Buchanani*.

Fig. 91. Interior of the air-bladder; ventral view.

Fig. 92. Ventral view of the anterior chamber;  $\times 3$ .

Fig. 95. *Pangasius juaro*.—Ventral view of the anterior vertebræ, and the "elastic-spring" apparatus;  $\times 4$ .

Fig. 96. *Pangasius micronema*.—Ventral view of the anterior vertebræ and their

processes, showing the absence of an "elastic-spring" mechanism; the left clavicle is withdrawn from its socket;  $\times 2$ .

Figs. 97, 98.—*Silonidia gangetica*.

Fig. 97. Ventral view of the cavity of the air-bladder.

Fig. 98. Enlarged view of the right half;  $\times 3$ .

## X.—REFERENCE LETTERS.

(The lettering is uniform throughout.)

### I. *Vertebral Column.*

<i>ac.p.</i>	Accessory articular processes.
<i>a.c.</i>	Aortic canal.
<i>a.g.</i>	Aortic groove.
<i>c.c.</i>	Complex centrum.
<i>cd.c.</i>	Cardinal canal.
<i>c.g.</i>	Cardinal groove.
<i>d.l.</i>	Dorsal lamina.
<i>i.s.<sup>1</sup>, i.s.<sup>2</sup>.</i>	First and second interspinous bones.
<i>it.c.</i>	Intercalated cartilage.
<i>n.s.<sup>3</sup>, n.s.<sup>4</sup>.</i>	Neural spines of the third and fourth vertebræ.
<i>n.f.</i>	Nutrient foramina.
<i>o.r.</i>	Oblique lateral ridge of the complex centrum.
<i>pt.f.</i>	Post-temporal facet on the transverse process of the fourth vertebra.
<i>r.<sup>1</sup>.</i>	First rib.
<i>r.n.</i>	Radial nodule.
<i>s.os.</i>	Superficial ossification of the complex centrum.
<i>sp.n.<sup>1</sup>, sp.n.<sup>2</sup>, &amp;c.</i>	Foramina for the exit of the first and succeeding spinal nerves.
<i>s.v.p.</i>	Sub-vertebral process.
<i>t.p.<sup>4</sup>.</i>	Transverse process of the fourth vertebra.
<i>t.p.<sup>4a</sup>.</i>	Anterior division of the transverse process of the fourth vertebra.
<i>t.p.<sup>4p</sup>.</i>	Posterior division of the transverse process of the fourth vertebra.
<i>t.p.<sup>5</sup>, t.p.<sup>6</sup>.</i>	Transverse processes of the fifth and sixth vertebræ.
<i>v<sup>1</sup>, v.<sup>5</sup>, v.<sup>6</sup>.</i>	First, fifth, and sixth vertebral centra.
<i>v.p.</i>	Ventral process.

### II.—*The Skull.*

<i>al.s.</i>	Alisphenoid.
<i>at.a.</i>	External atrial aperture.
<i>b.o.</i>	Basioccipital.

<i>cr.c.</i>	Cranial cavity.
<i>c.s.i.</i>	Cavum sinus imparis.
<i>e.o.</i>	Exoccipital.
<i>e.o.</i> <sup>1.</sup>	Neural plate of exoccipital.
<i>e.o.</i> <sup>2.</sup>	Posterior plate of exoccipital.
<i>e.o.</i> <sup>3.</sup>	Opisthotic plate of exoccipital.
<i>e.o.</i> <sup>4.</sup>	Horizontal plate of exoccipital.
<i>ep.o.</i>	Epiotic.
<i>f.mg.</i>	Foramen magnum.
<i>f.s.</i>	Cranial recesses for the sacculi (fovæ sacculi).
<i>h.c.</i>	Canal for horizontal semicircular canal.
<i>l.g.</i>	Lateral groove for the ductus sacculo-utricularis.
<i>o.s.</i>	Orbitosphenoid.
<i>p.</i>	Parasphenoid.
<i>pt.o.</i>	Pterotic.
<i>pr.o.</i>	Prootic.
<i>s.o.</i>	Supraoccipital.
<i>so.</i>	Supraoccipital spine.
<i>sp.o.</i>	Sphenotic.
<i>t.g.</i>	Transverse groove for the ductus endolymphaticus.
<i>tp.f.</i>	Temporal fossa.
<i>ut.r.</i>	Recess for the utriculus and semicircular canals.
V, V'	Foramina for the Fifth cranial nerve (Trigeminal) and for its lateral branch.
VII, IX, X.	Foramina for the Seventh (Facial), Ninth (Glossopharyngeal), and Tenth (Vagus) nerves respectively.

### III.—*Pectoral Girdle.*

<i>cl.</i>	Clavicle.
<i>cl.s.</i>	Socket for the head of the clavicle.
<i>cl.p.</i>	Posterior process of the clavicle.
<i>cl.p'</i>	Additional posterior process of clavicle.
<i>co.</i>	Coracoid.
<i>pt.</i>	Post-temporal.
<i>pt.a.</i>	Ascending process of the post-temporal.
<i>pt.i.</i>	Inferior process or limb of post-temporal.
<i>pt.p.</i>	Post-temporal plate.
<i>pt.s.</i>	Descending process or stem of post-temporal.

IV.—*The Auditory Organ.*

<i>at.</i>	Atrial cavity.
<i>at.a.</i>	External atrial aperture.
<i>a.v.c.</i>	Anterior semi-circular canal.
<i>c.s.i.</i>	Cavum sinus imparis.
<i>d.e.</i>	Ductus endolymphaticus.
<i>d.s.u.</i>	Ductus sacculo-utricularis.
<i>f.s.</i>	Foveæ sacculi.
<i>h.c.</i>	Horizontal semi-circular canal.
<i>p.v.c.</i>	Posterior semi-circular canal.
<i>s.e.</i>	Sinus endolymphaticus.
<i>s.</i>	Sacculus.
<i>ut.</i>	Utriculus.

V.—*The Air-bladder.*

<i>a.b.</i>	Air-bladder.
<i>a.c.</i>	Anterior chamber.
<i>al.c.</i>	Antero-lateral cæcum.
<i>a.p.</i>	Anterior pillars.
<i>a.s.</i>	Air sac.
<i>c.dv.</i>	Cæcal diverticulum.
<i>cp.m.</i>	Compressor muscle.
<i>d.p.</i>	Ductus pneumaticus.
<i>in.l.</i>	Inner lateral cæcum of air-bladder.
<i>in.st.</i>	Inner stratum of tunica externa.
<i>l.c.</i>	Lateral chamber.
<i>l.s.</i>	Longitudinal septum.
<i>o.l.</i>	Outer lateral cæcum of air-bladder.
<i>o.st.</i>	Outer stratum of tunica externa.
<i>p.</i>	Peritoneum.
<i>p.c.</i>	Posterior cæcum.
<i>p.p.</i>	Posterior pillars.
<i>pt.m.</i>	Protractor muscle of the "elastic-spring" mechanism.
<i>r.f.</i>	Radial fibres of the tripodes.
<i>r.s.</i>	Fibrous ridge on the inner surface of the ventral wall of the anterior chamber.
<i>sv.k.</i>	Subvertebral keel.
<i>sv.k'.</i>	Projection of subvertebral keel into the dorsal wall of the anterior chamber.
<i>t.m.</i>	Transverse membrane.

<i>t.s.</i>	Primary transverse septum.
<i>t.s'.</i>	Secondary transverse septum.
<i>t.t.</i>	Tensor tripodis muscle.

VI.—*Weberian ossicles.*

<i>c.</i>	Clastrum.
<i>i.lg.</i>	Interossicular ligament.
<i>in.</i>	Intercalarium.
<i>in.a.</i>	Ascending process of the intercalarium.
<i>in.h.</i>	Horizontal process of the intercalarium.
<i>sc.</i>	Scaphium.
<i>sc.a.</i>	Ascending process of the scaphium.
<i>sc.s.</i>	Spatulate process of the scaphium.
<i>s.pv.</i>	Saccus paravertebralis.
<i>tr.</i>	Tripus.
<i>tr.a.</i>	Anterior process of the tripus.
<i>tr.ar.</i>	Articular process of the tripus.
<i>tr.c.</i>	Crescentic process of the tripus.
<i>tr.h.</i>	Heel-like process of the tripus.
<i>v.r.</i>	Ventral ridge of the tripus.

VII.—*Other structures.*

<i>ac.br.</i>	Accessory branchiæ.
<i>ap.m.</i>	Aponeurotic membrane.
<i>d.l.m.</i>	Dorso-lateral muscles of the trunk.
<i>l.c.a.</i>	Lateral cutaneous areas.
<i>lgt.</i>	Ligament.
<i>l.l.c.</i>	Lateral line canal.
<i>mes.</i>	Mesentery.
<i>mph.</i>	Mesonephros.
<i>mph.r.</i>	Recesses for the "head" kidney.
<i>oes.</i>	Œsophagus.
<i>p.c.s.</i>	Peritoneal cul-de-sacs for the lateral lobes of the liver.
<i>v.l.m.</i>	Ventro-lateral muscles of the trunk.

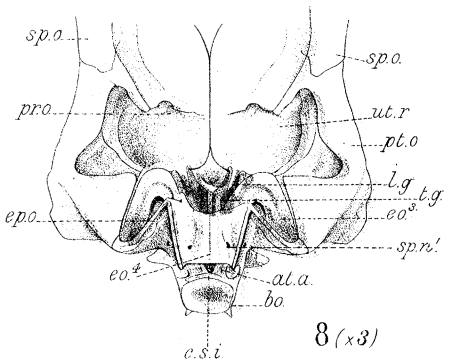
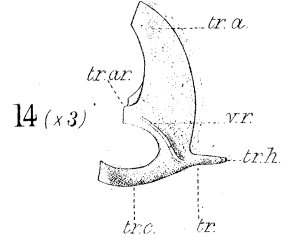
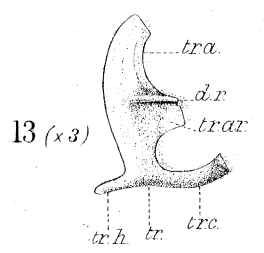
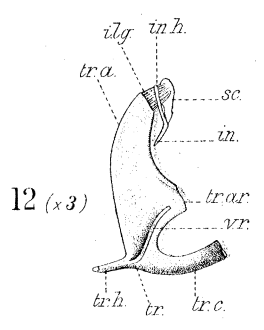
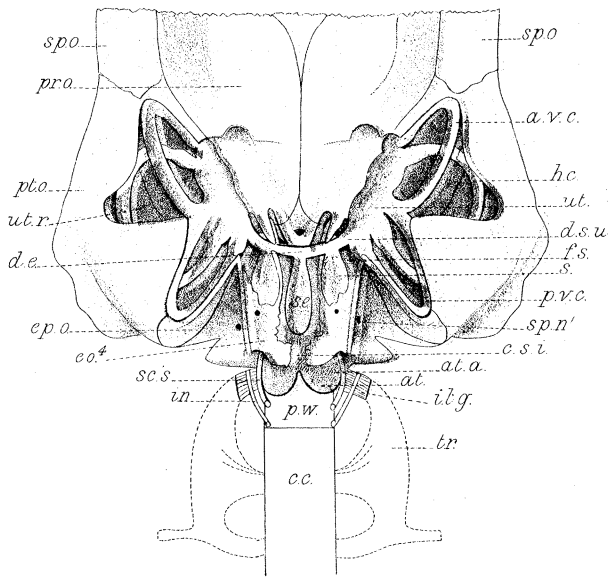
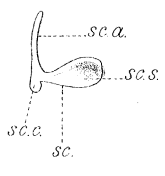
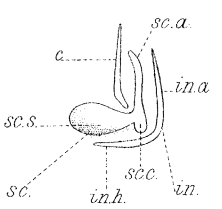
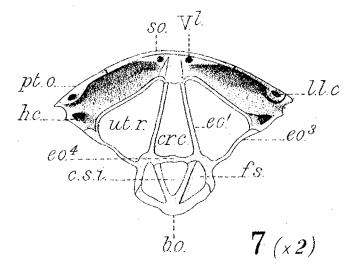
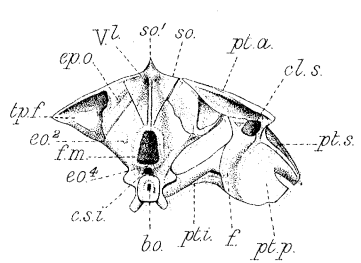
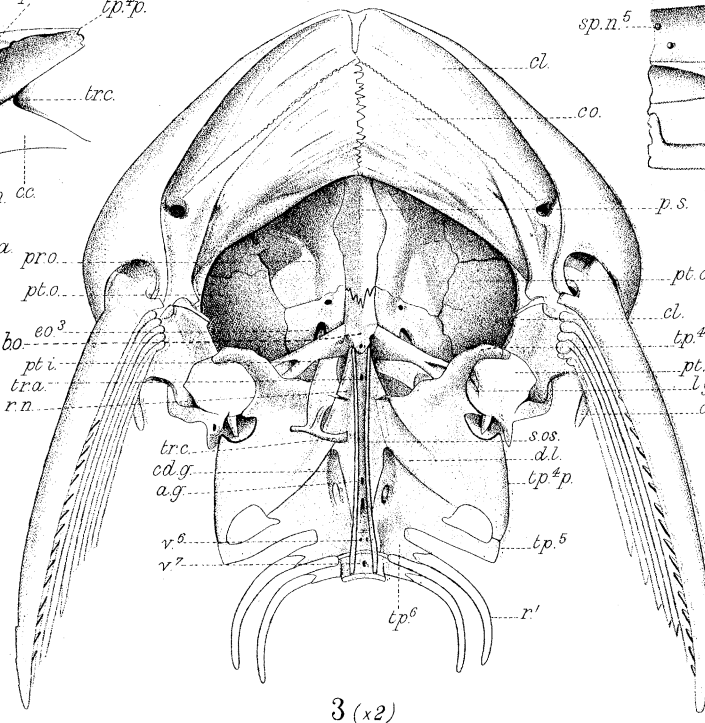
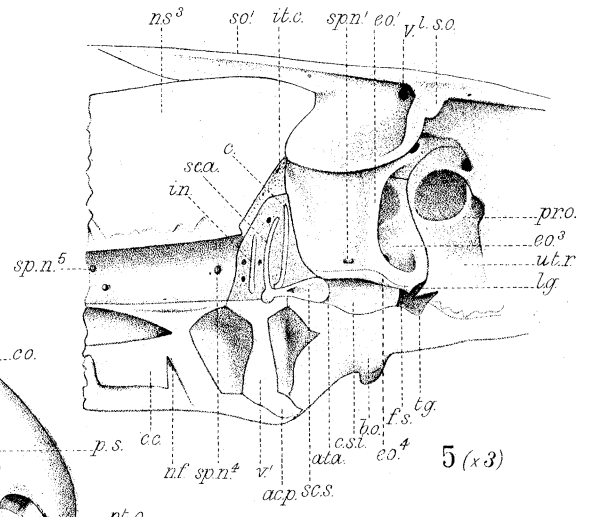
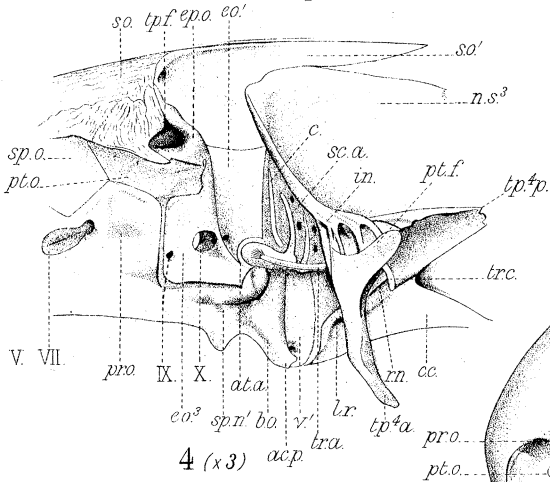
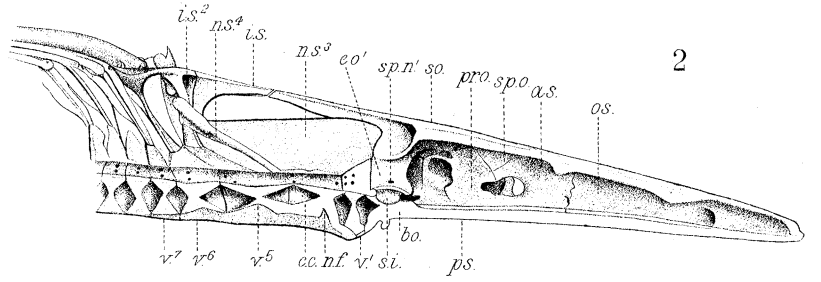
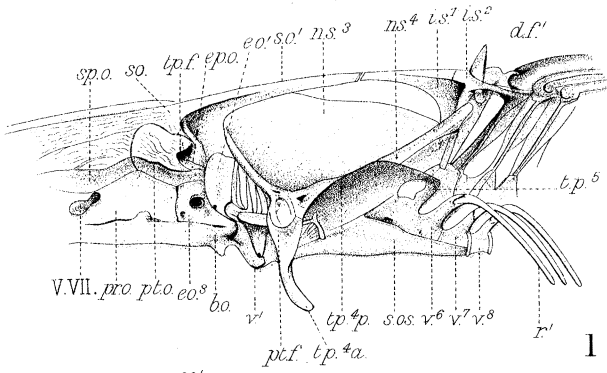

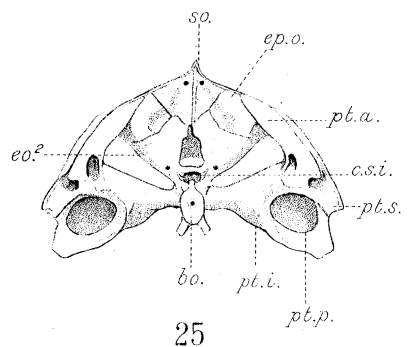
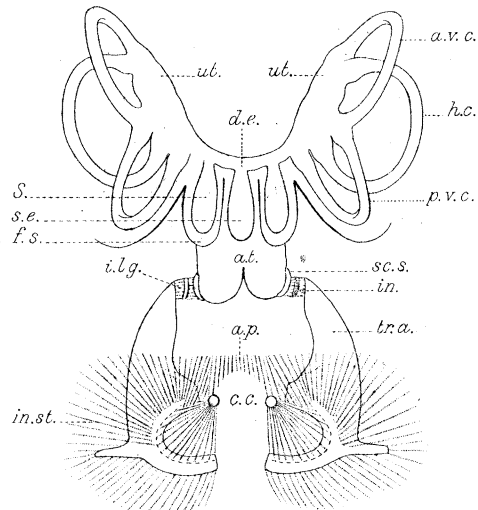
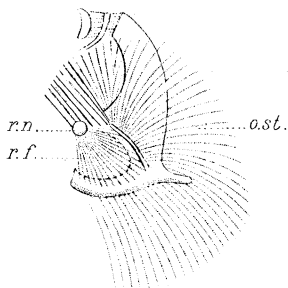
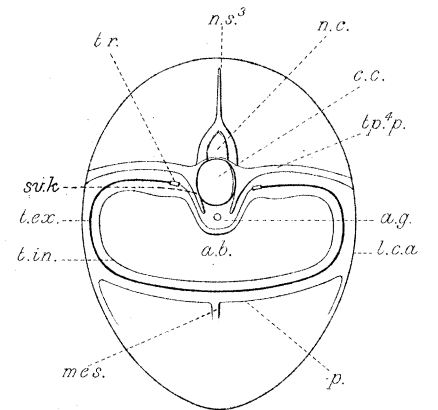
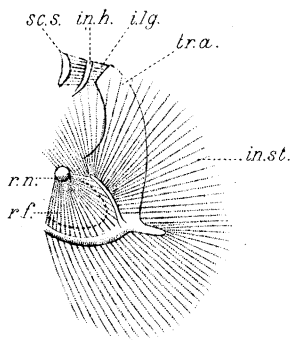
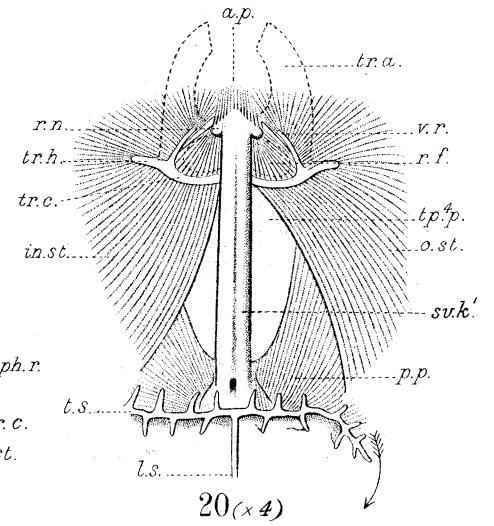
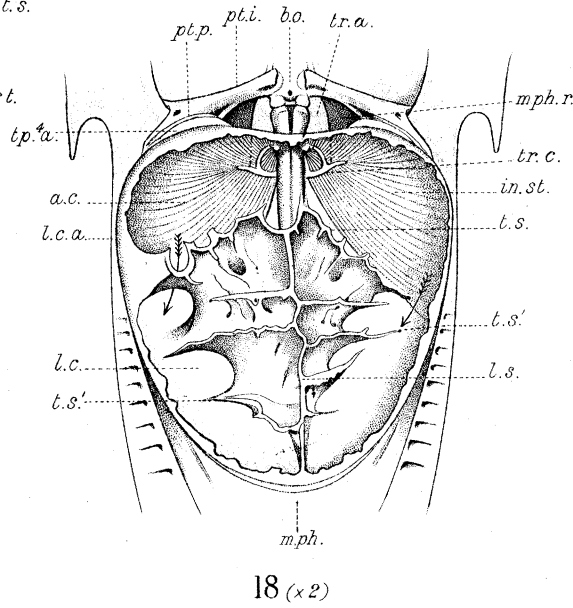
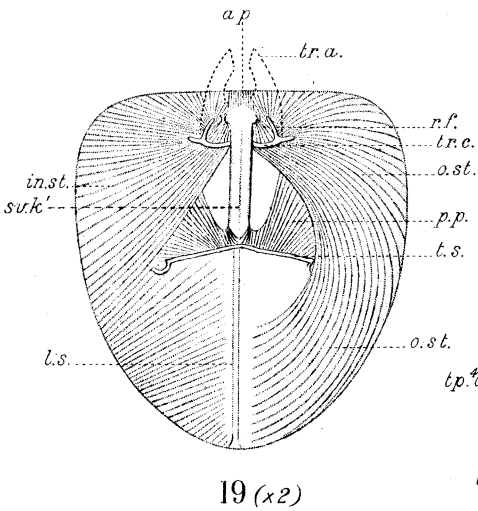
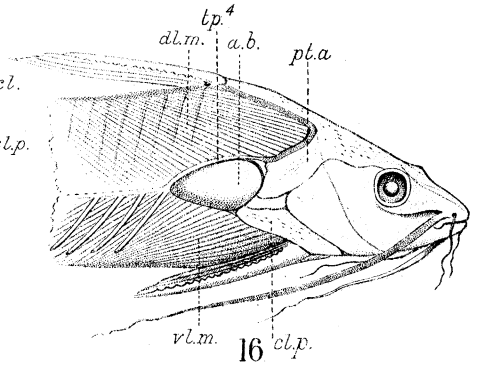
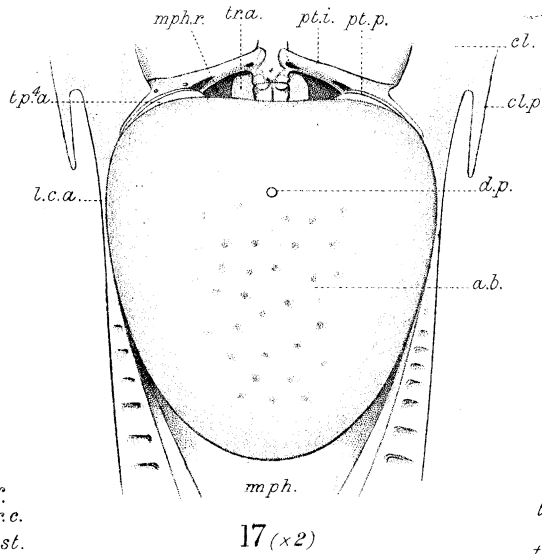
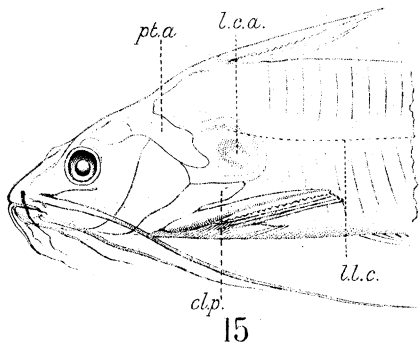

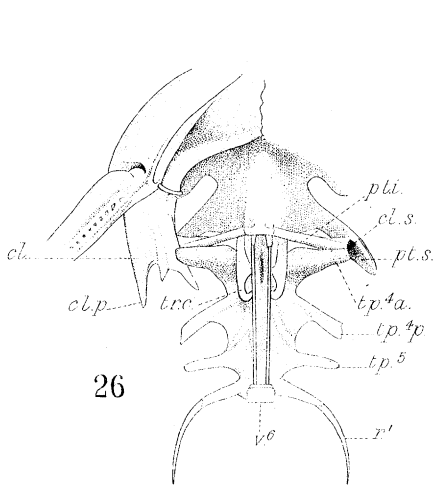

26

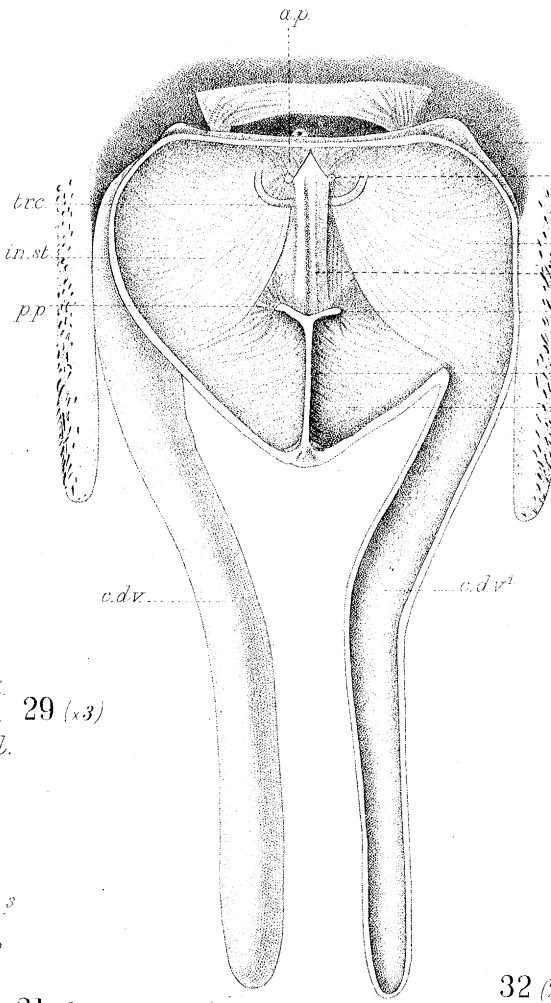

27

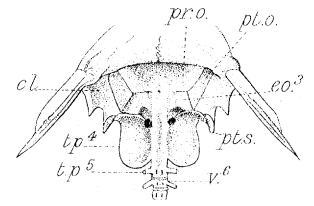

28 (x3)

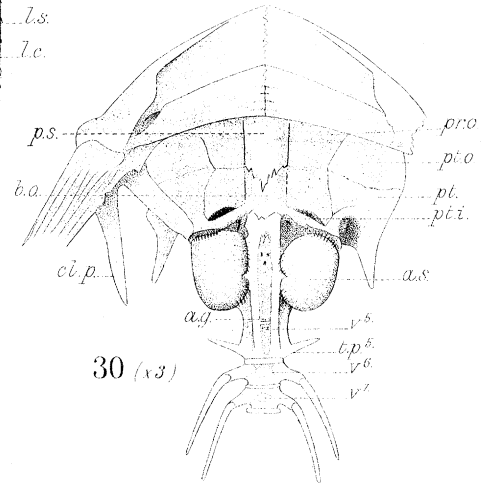

30 (x3)

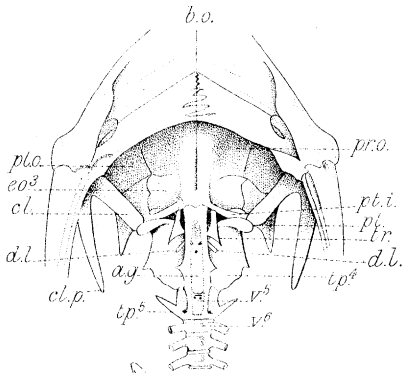

29 (x3)

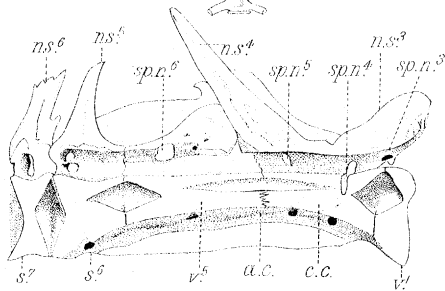

31 (1/2)

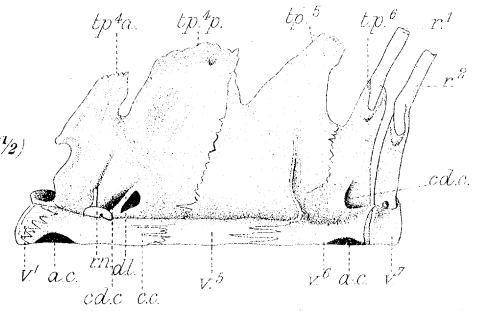

32 (1/2)

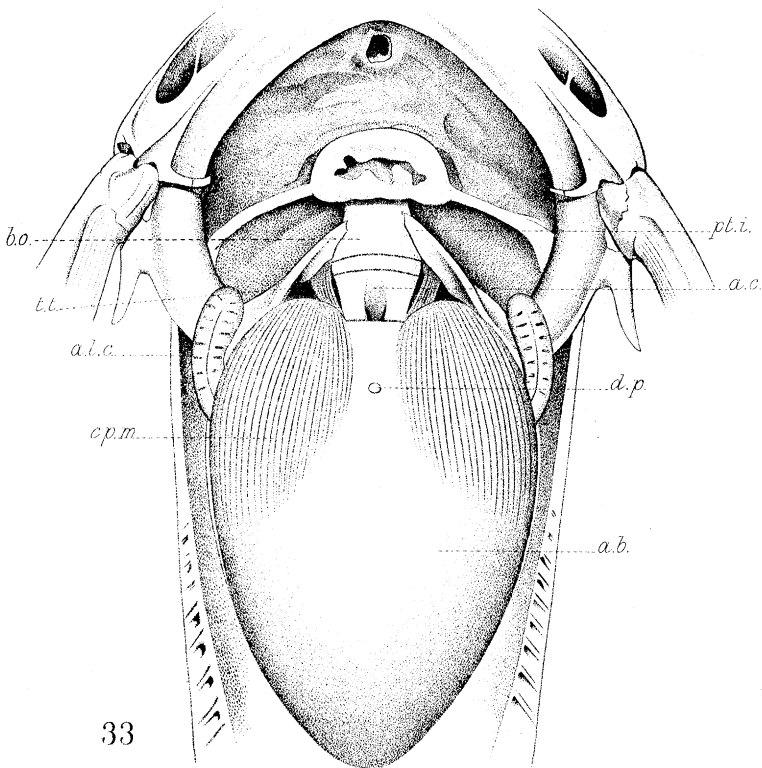

33

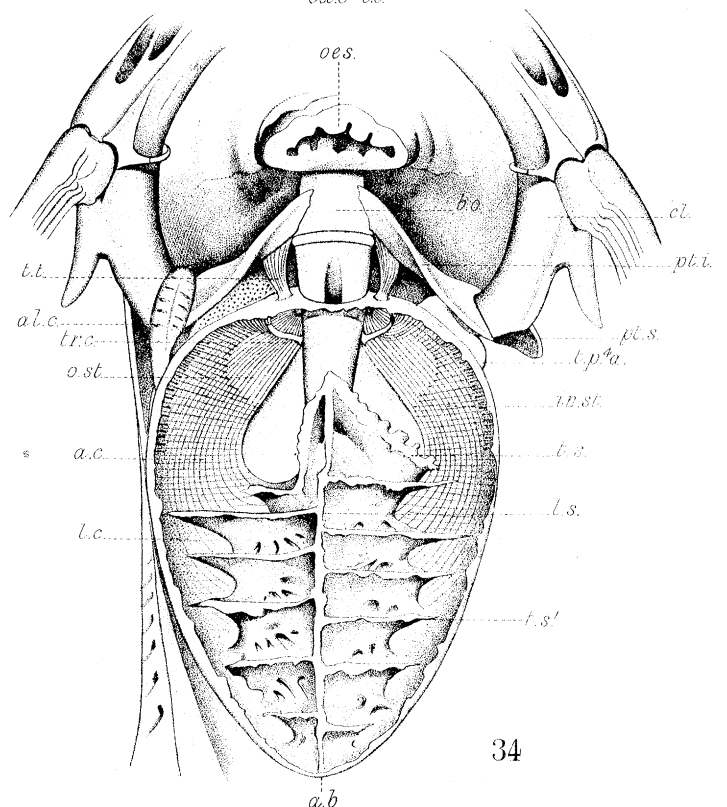

34



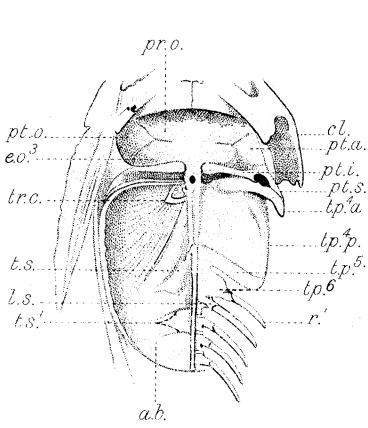

35(x2)

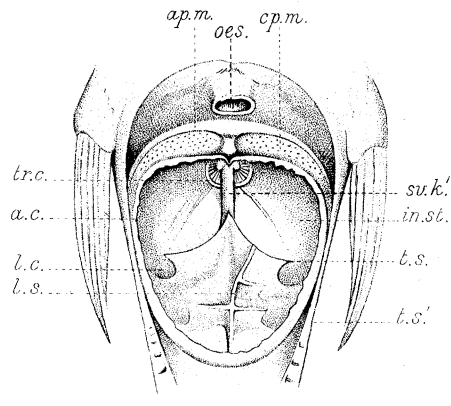

36(x2)

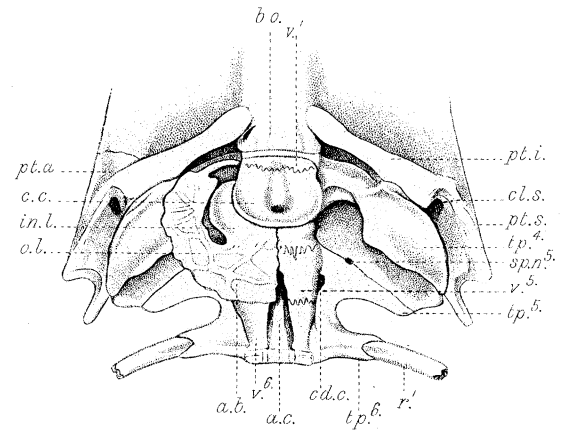

37(x1 1/2)

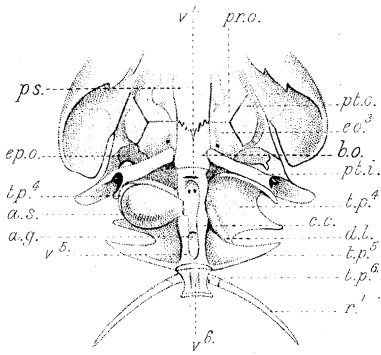

39(x2)

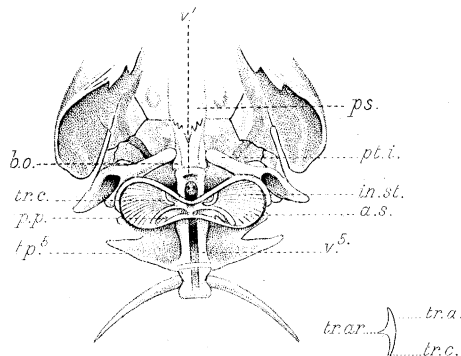

40(x2)

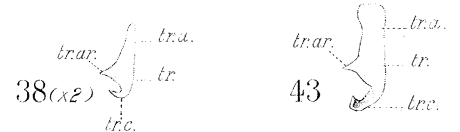

38(x2)

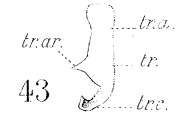

43

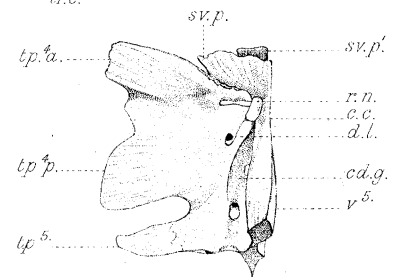

41(x2)

42

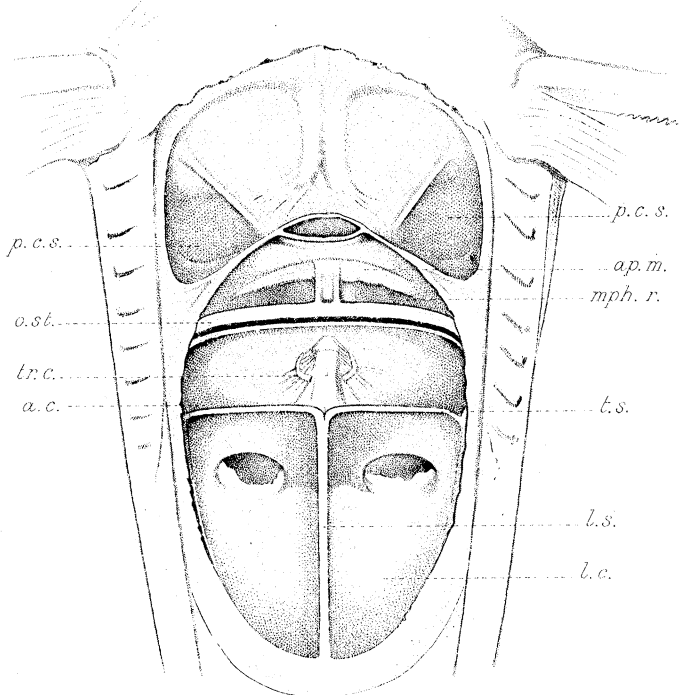

44

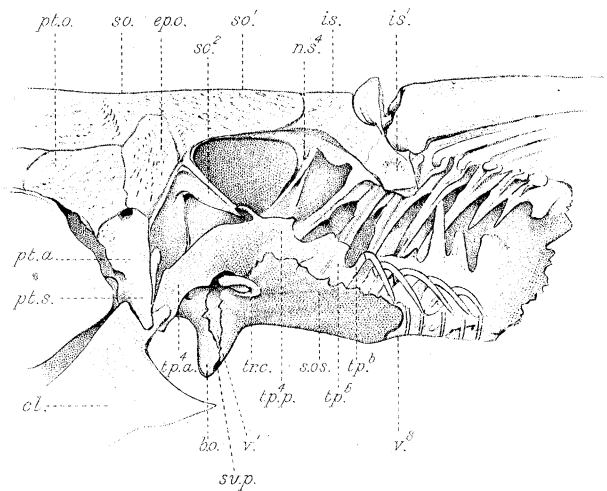

45

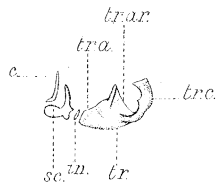

49

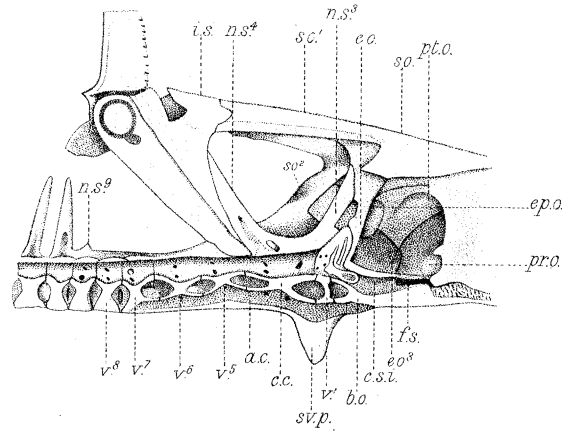

46

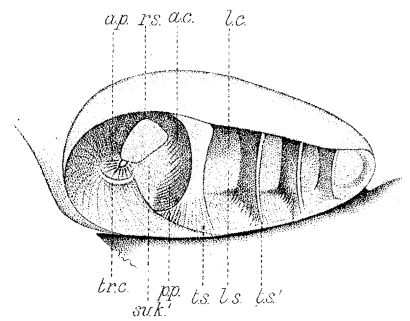

50

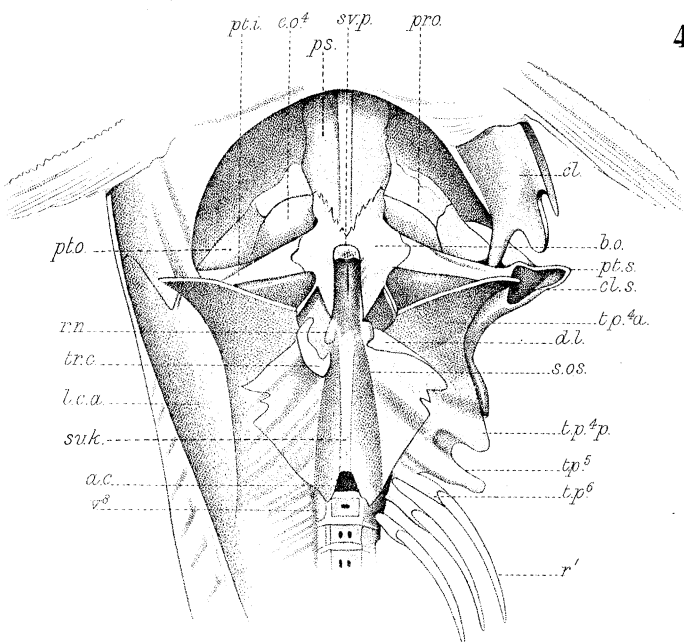

47

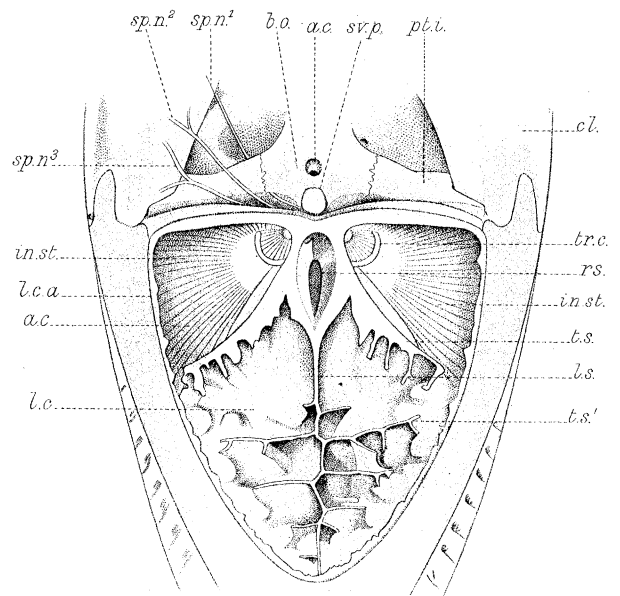

48

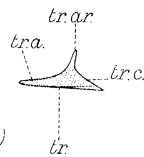

54 (x2)

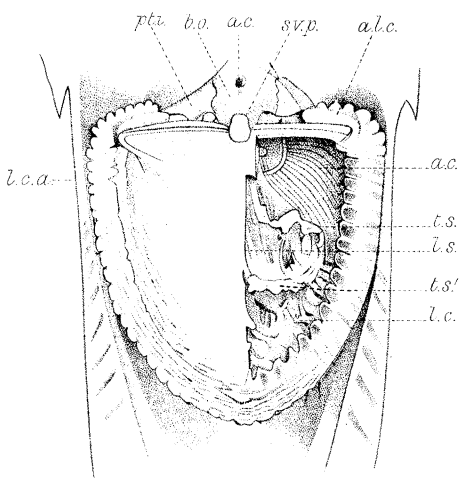

51

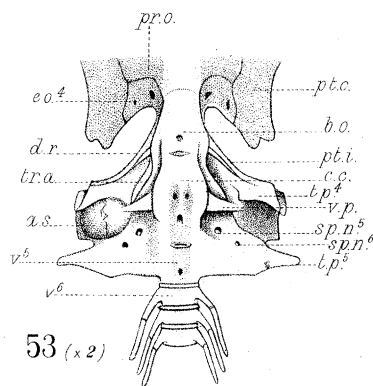

53 (x2)

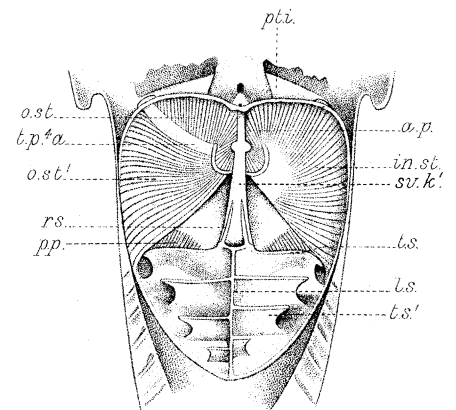

52

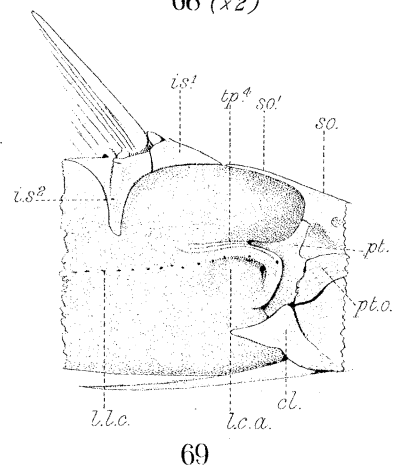
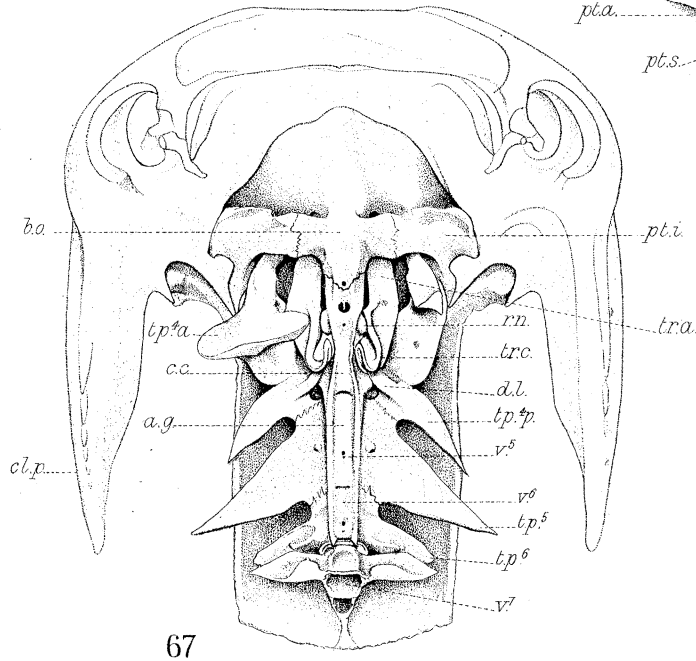
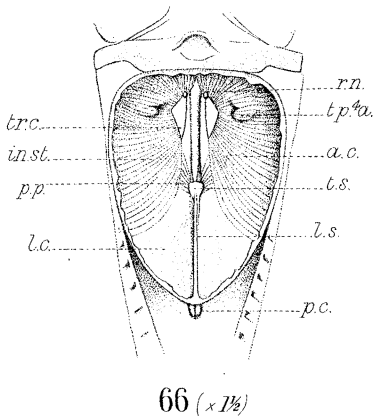
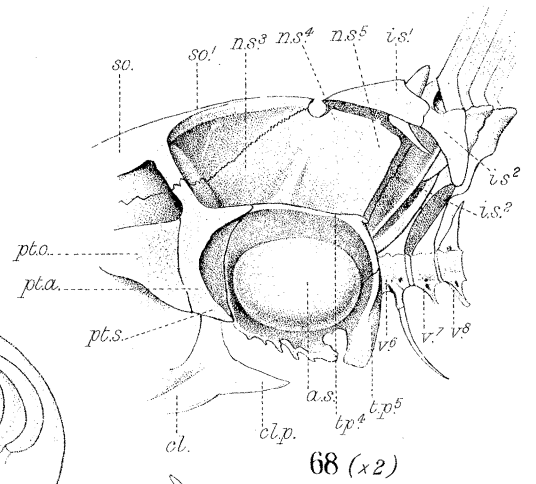
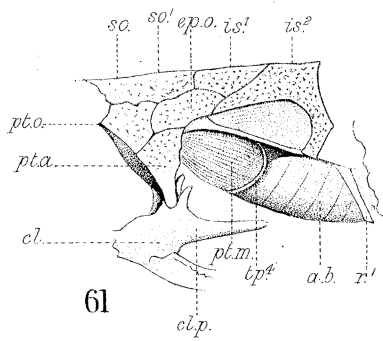
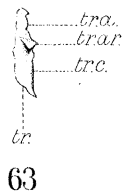
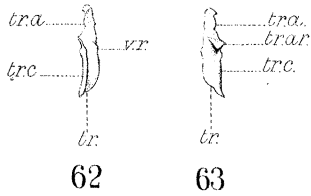
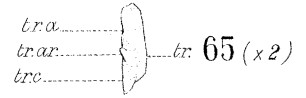
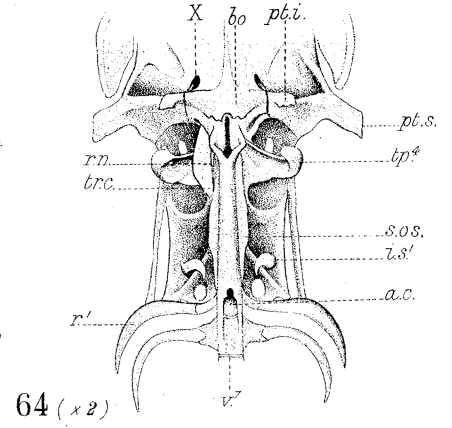
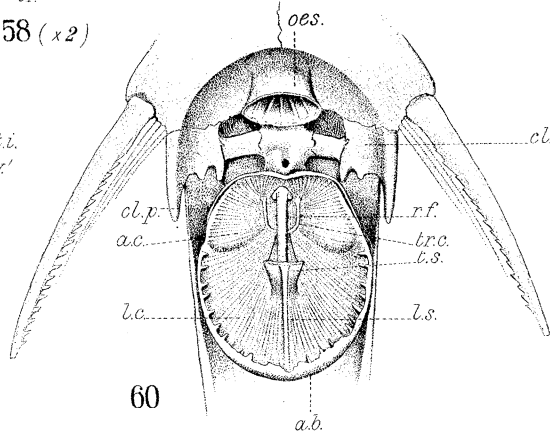
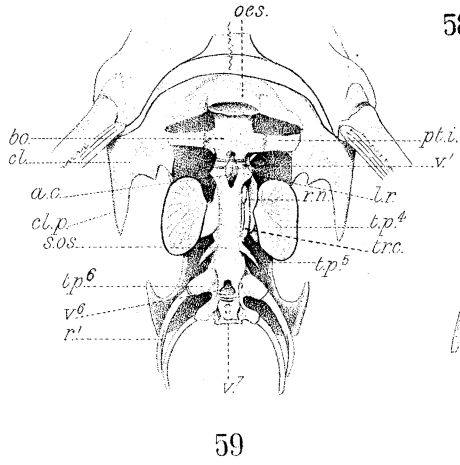
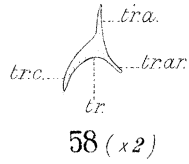
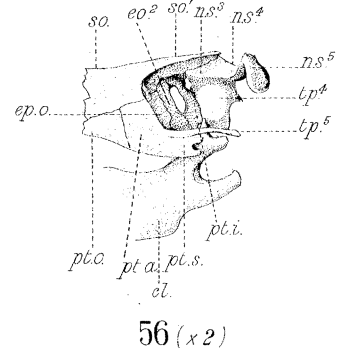
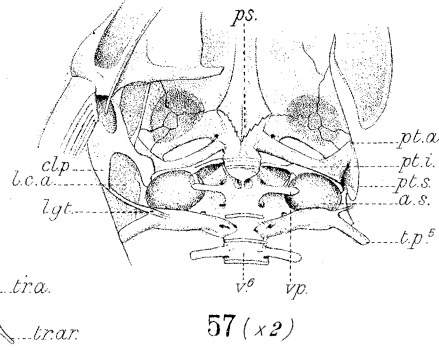
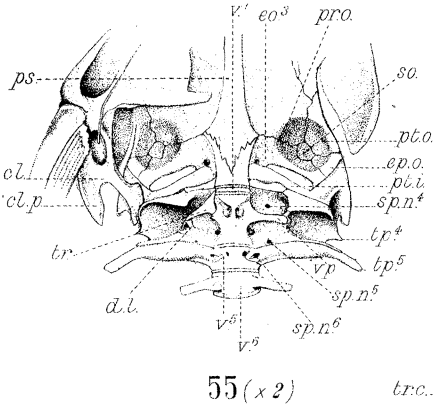

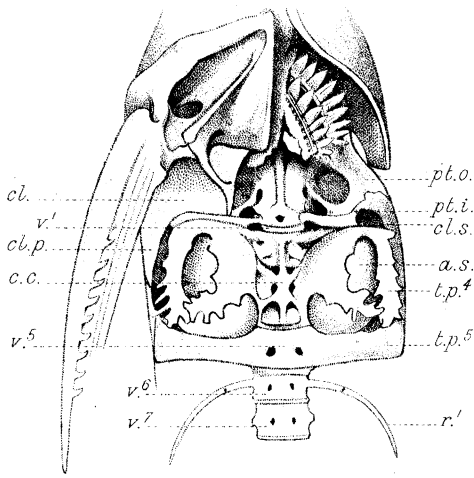

70 (x2)

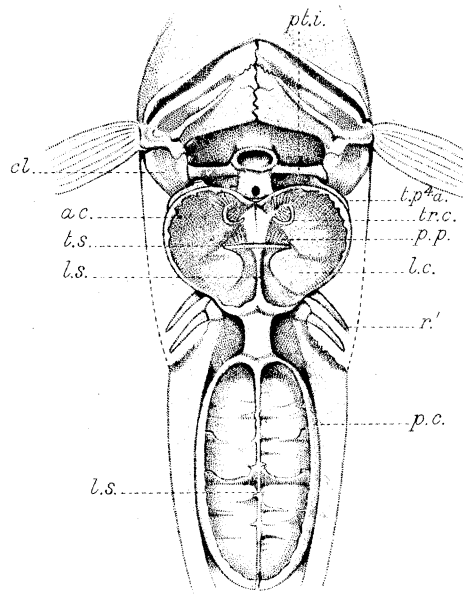

71

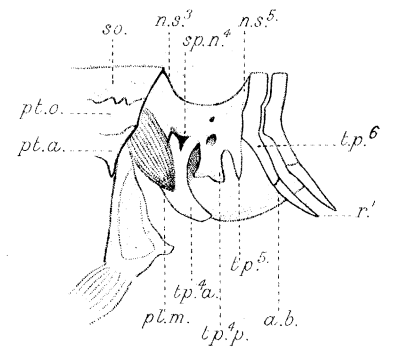

72

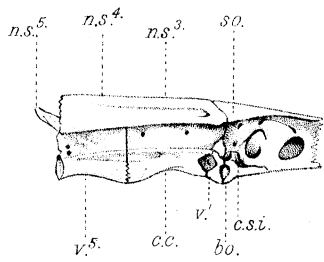

74 (x2)

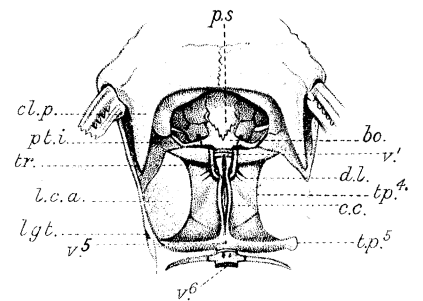

73

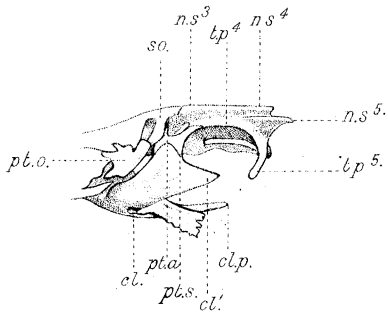

75

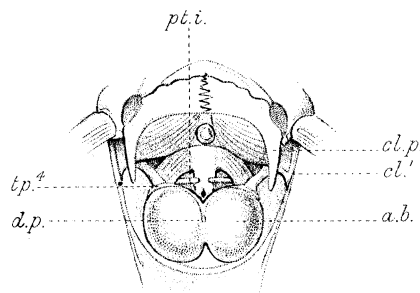

76

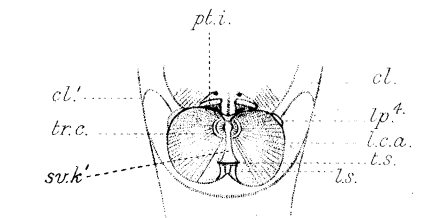

77

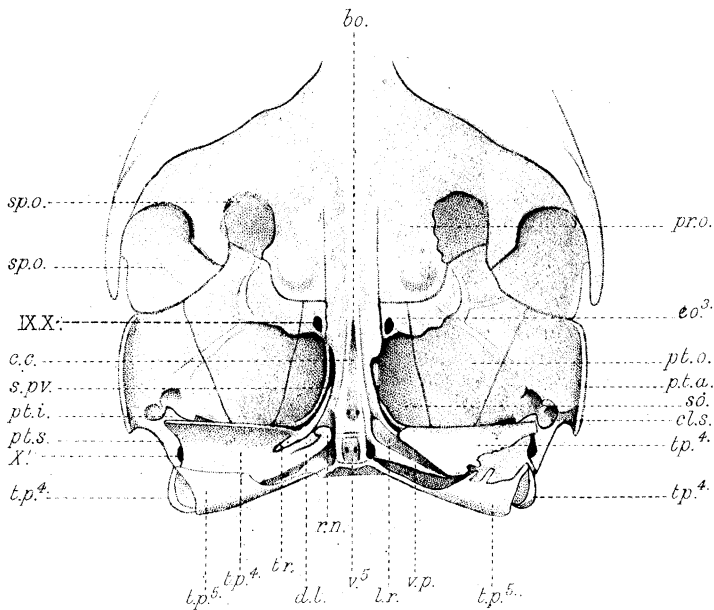

78 (x2)

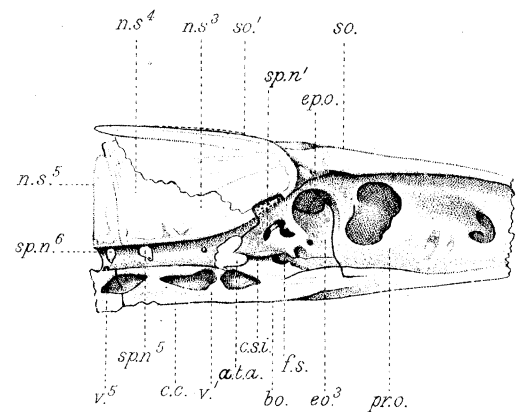

79 (x2)

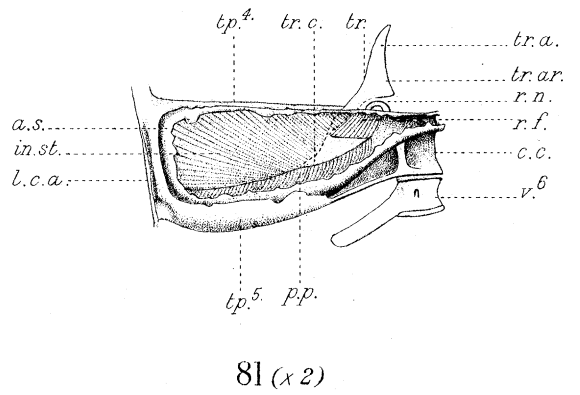
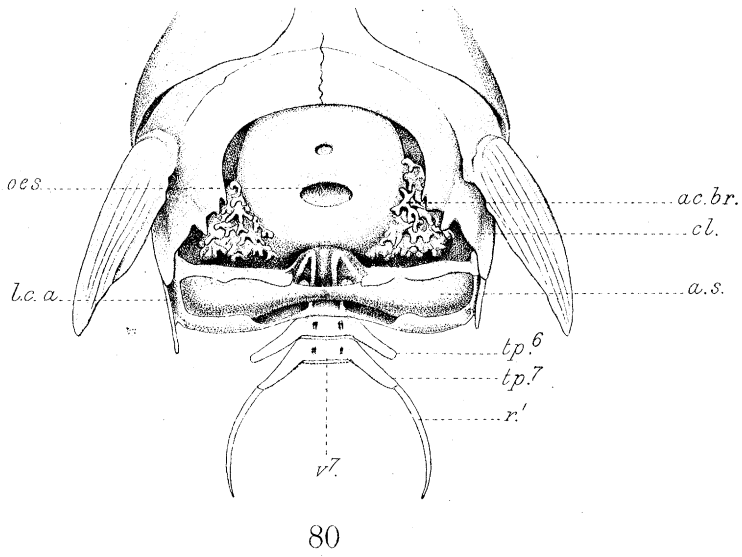

81 (x2)

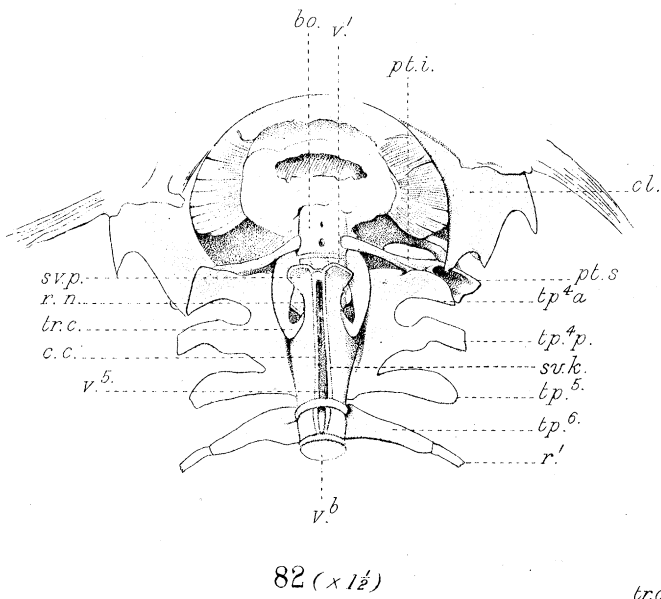

82 (x1½)

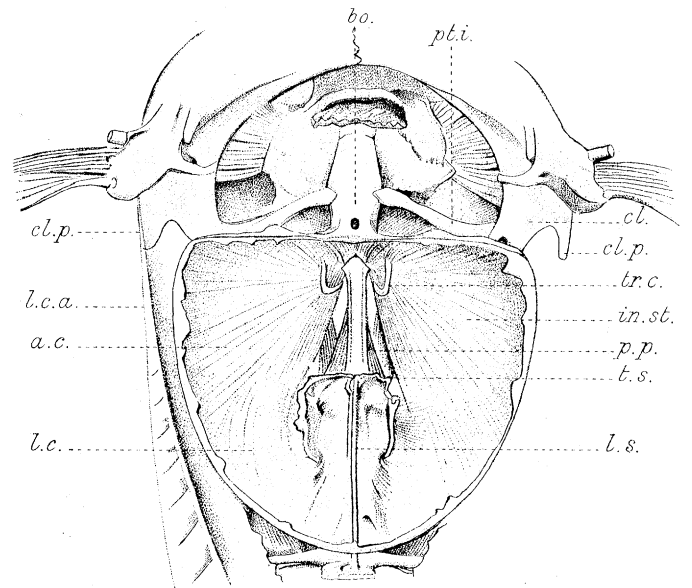

83 (x2)

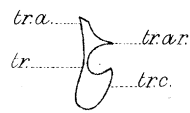

83a (x1½)

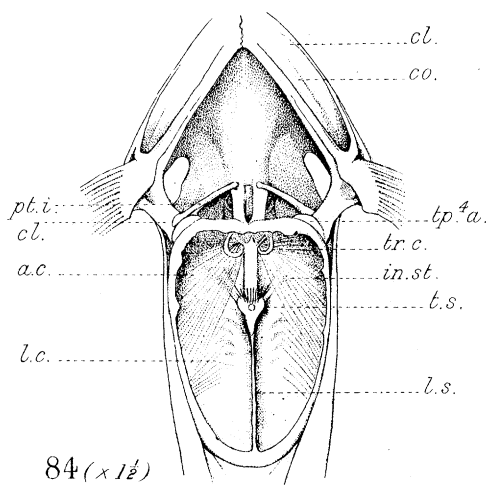

84 (x1½)

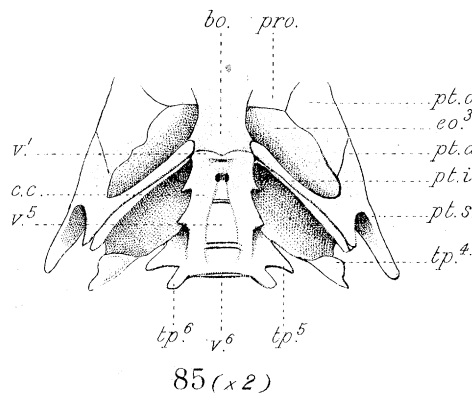

85 (x2)

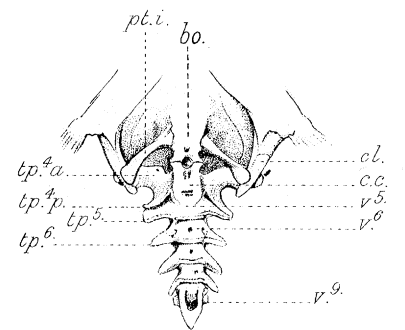

86 (x2)

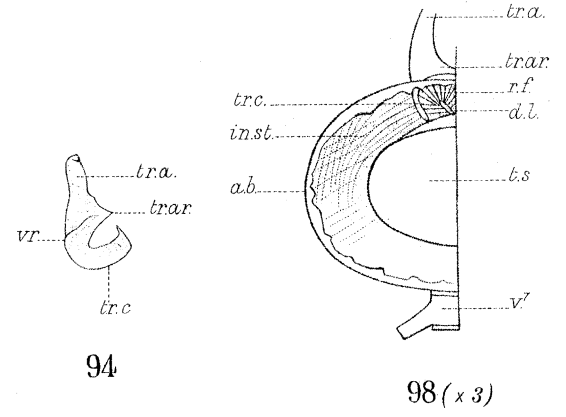
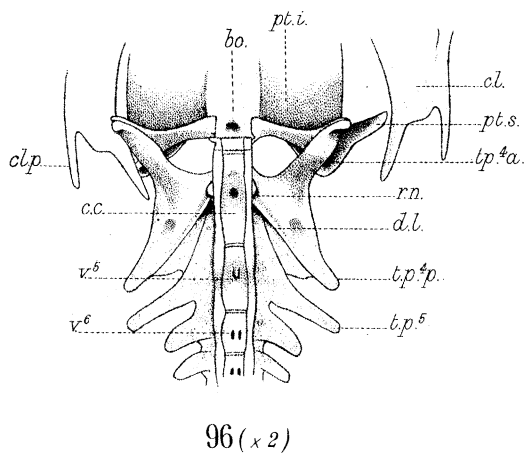
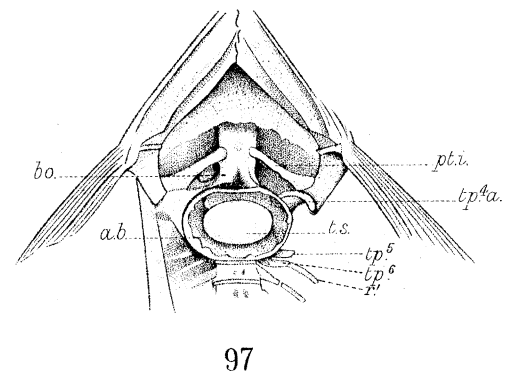
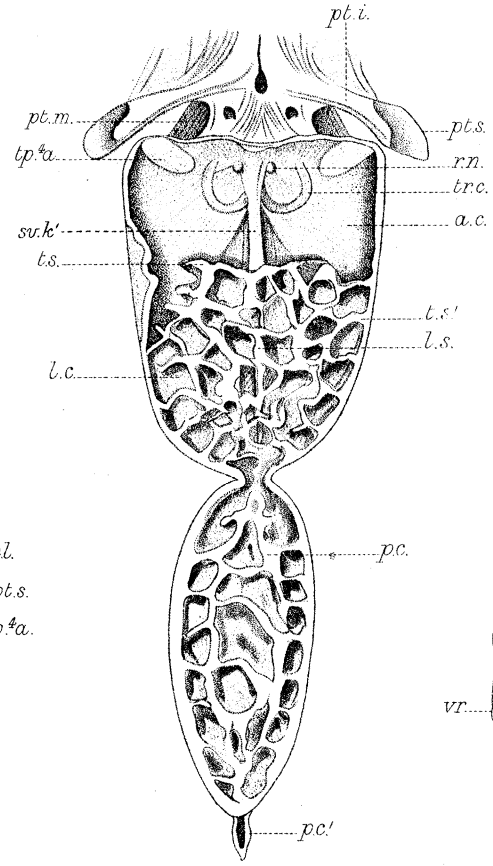
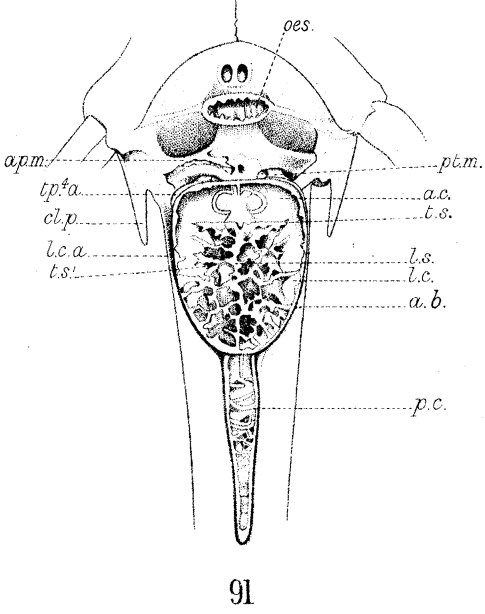
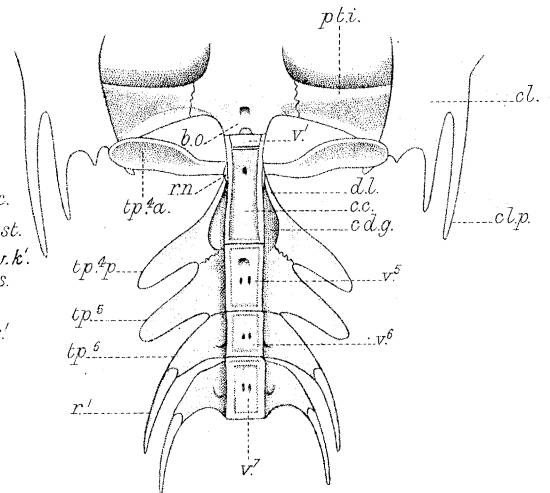
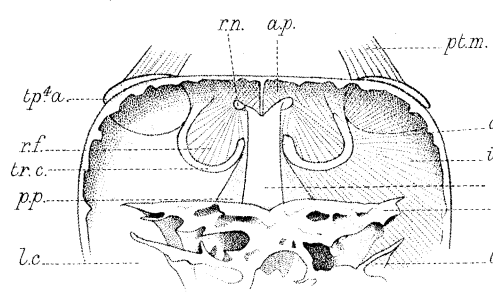
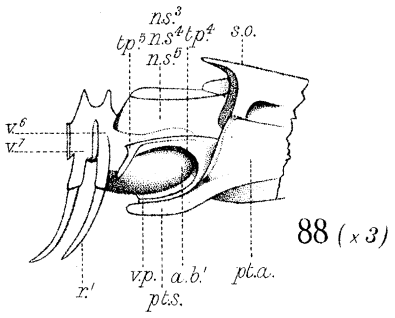
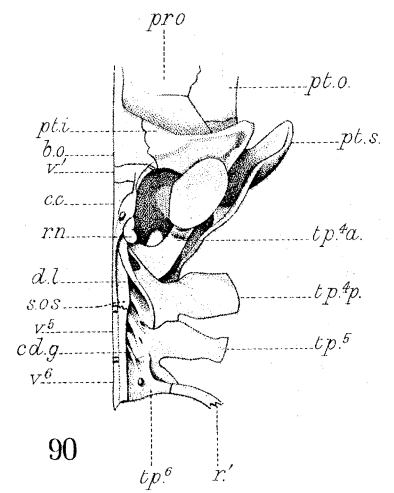
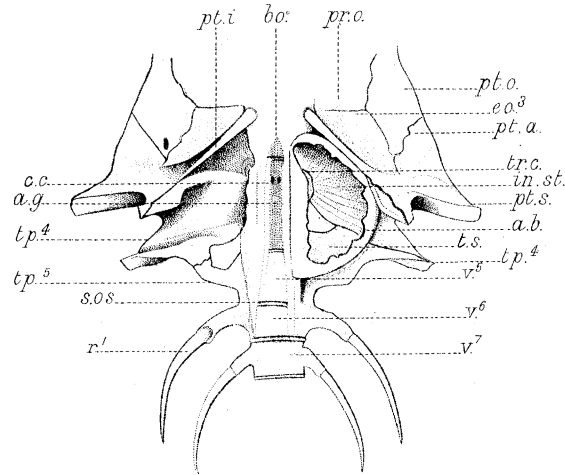
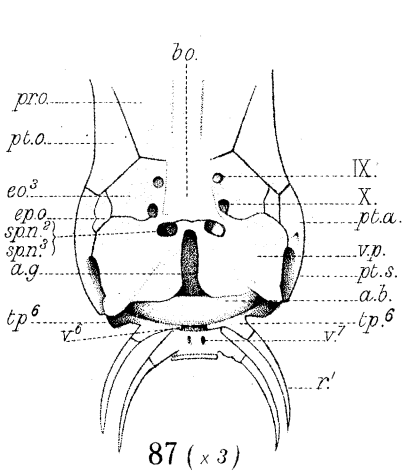

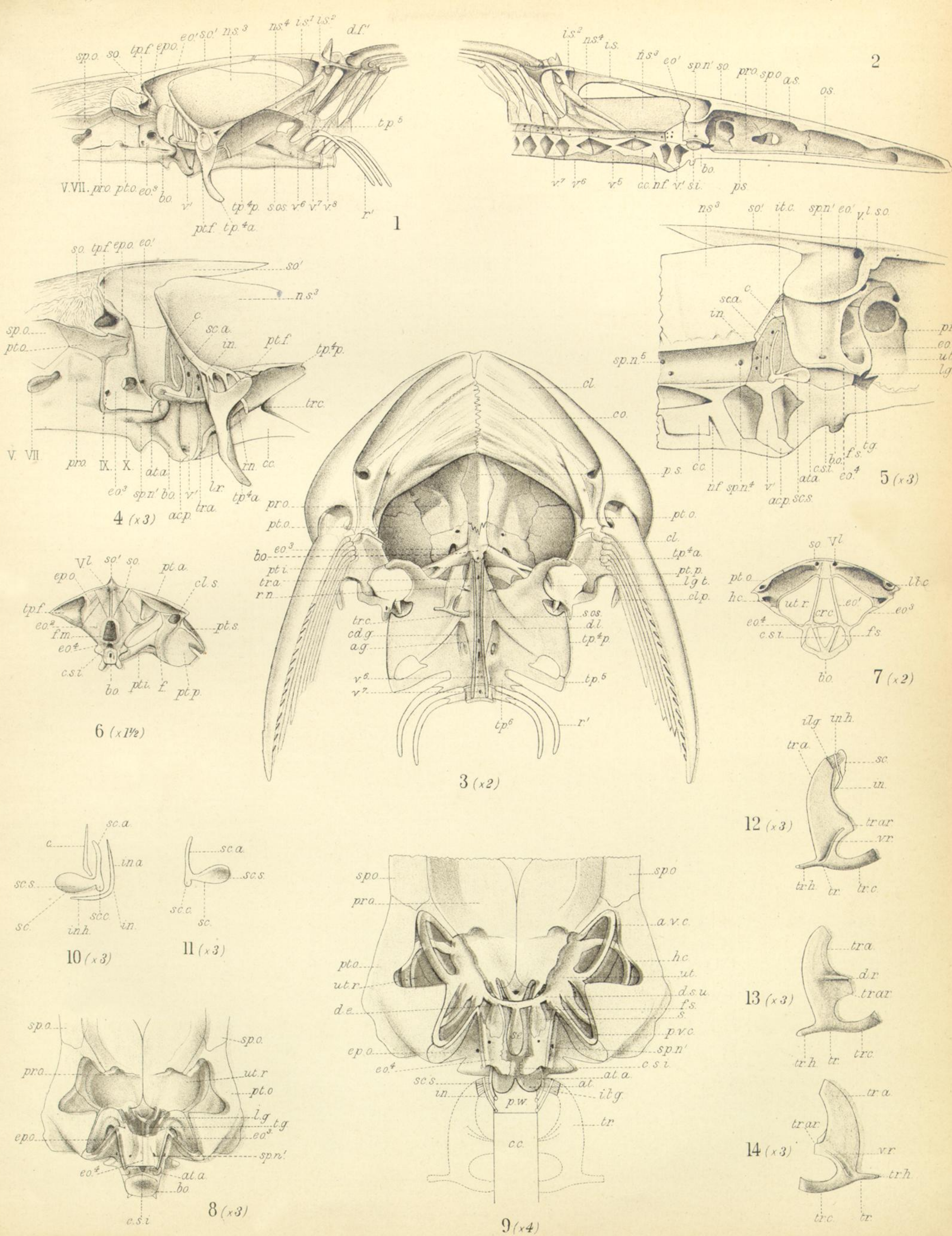

PLATE XI.

Figs. 1-6 and 8-24.—*Macrones nemurus*.

- Fig. 1. Lateral view of the skull and anterior vertebrae.
- Fig. 2. Vertical longitudinal section.
- Fig. 3. Ventral view of hinder part of skull and the anterior vertebrae;  
× 2.
- Fig. 4. Lateral view; × 3.
- Fig. 5. Vertical longitudinal section of the hinder part of the skull, and of  
the first and complex vertebrae; × 3.
- Fig. 6. Posterior face of the skull and the post-temporal of the left side;  
× 1½.
- Fig. 7. Transverse section through the occipital region of the skull of  
*Macrones aor*; × 2.
- Fig. 8. View of the cranial floor and auditory capsules, the roof of the skull  
having been removed; × 3.
- Fig. 9. A similar view, but with the membranous labyrinth *in situ*, so as  
to show the relations of the latter to the Weberian ossicles;  
semi-diagrammatic; × 4.
- Fig. 10. The Weberian ossicles; external lateral view, × 3.
- Fig. 11. The scaphium; internal view; × 3.
- Fig. 12. The Weberian ossicles; ventral view; × 3.
- Fig. 13. The tripus; dorsal view; × 3.
- Fig. 14. The tripus; ventral view; × 3.

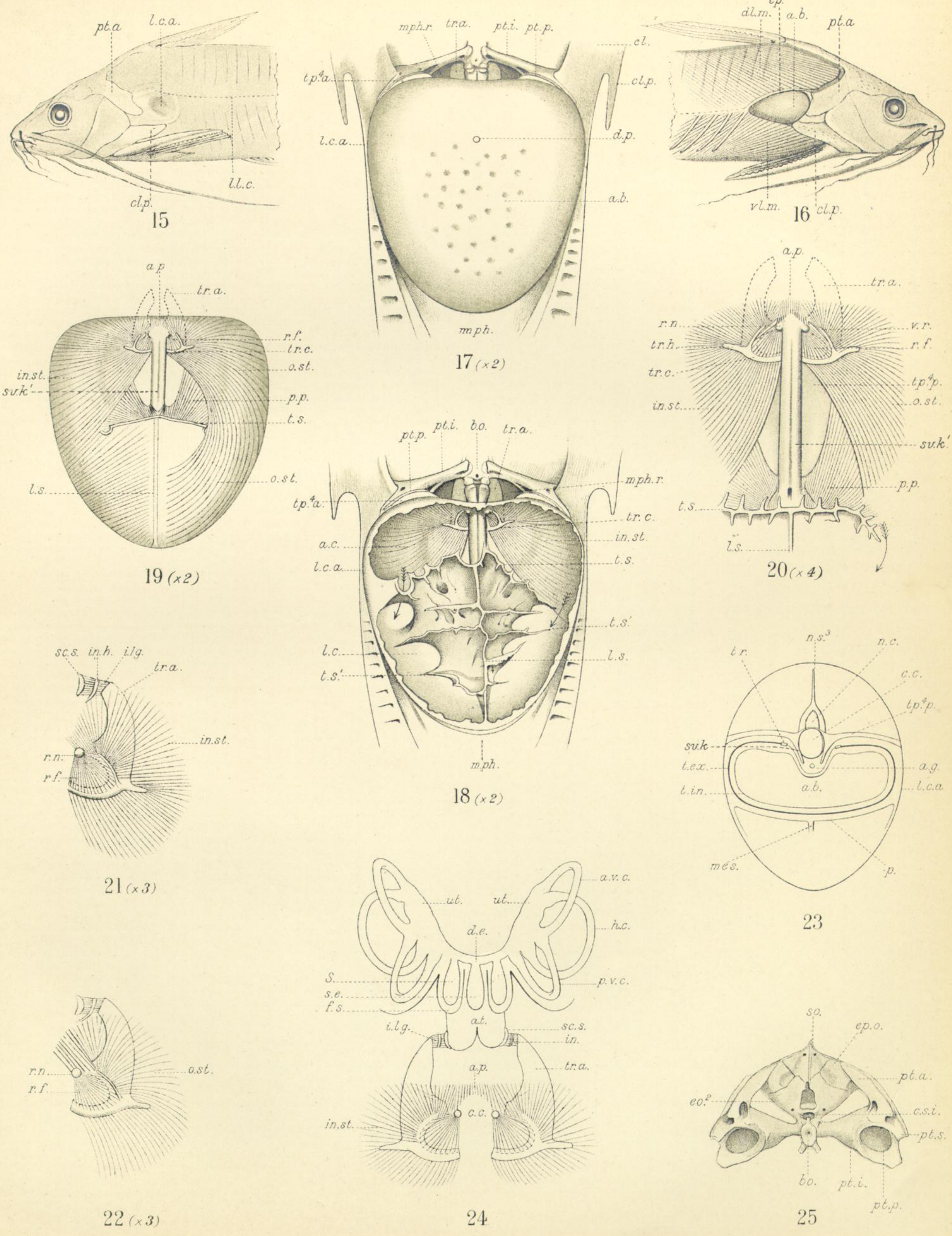

PLATE XII.

- Fig. 15. Lateral view of the head and anterior portion of the trunk.  
 Fig. 16. Lateral view of the head and anterior portion of the trunk, after the removal of the external skin on the right side.  
 Fig. 17. Ventral view of the air-bladder *in situ*;  $\times 2$ .  
 Fig. 18. Ventral view of the air-bladder *in situ*; after the removal of its ventral wall;  $\times 2$ .  
 Fig. 19. The dorsal and lateral walls of the air-bladder, showing the arrangement of the fibres forming the outer and inner strata of the tunica externa; their relations to the tripodes, and the anterior and posterior pillars of the anterior chamber; semi-diagrammatic;  $\times 2$ .  
 Fig. 20. Similar view of part of the dorsal wall of the anterior chamber;  $\times 4$ .  
 Fig. 21. Weberian ossicles; ventral view, showing the attachment of the fibres of the inner stratum of the tunica externa to the left tripus, and also the radial fibres;  $\times 3$ .  
 Fig. 22. Similar view of the attachment of the fibres of the outer stratum;  $\times 3$ .  
 Fig. 23. Transverse section through the body in the region of the anterior chamber of the air-bladder; semi-diagrammatic.  
 Fig. 24. Diagrammatic representation of the relations of the auditory organ, the cavum sinus imparis, and the atrial cavities to the Weberian ossicles and air-bladder.

Fig. 25.—*Macrones aor.* View of the posterior face of the skull with the post-temporals *in situ*.



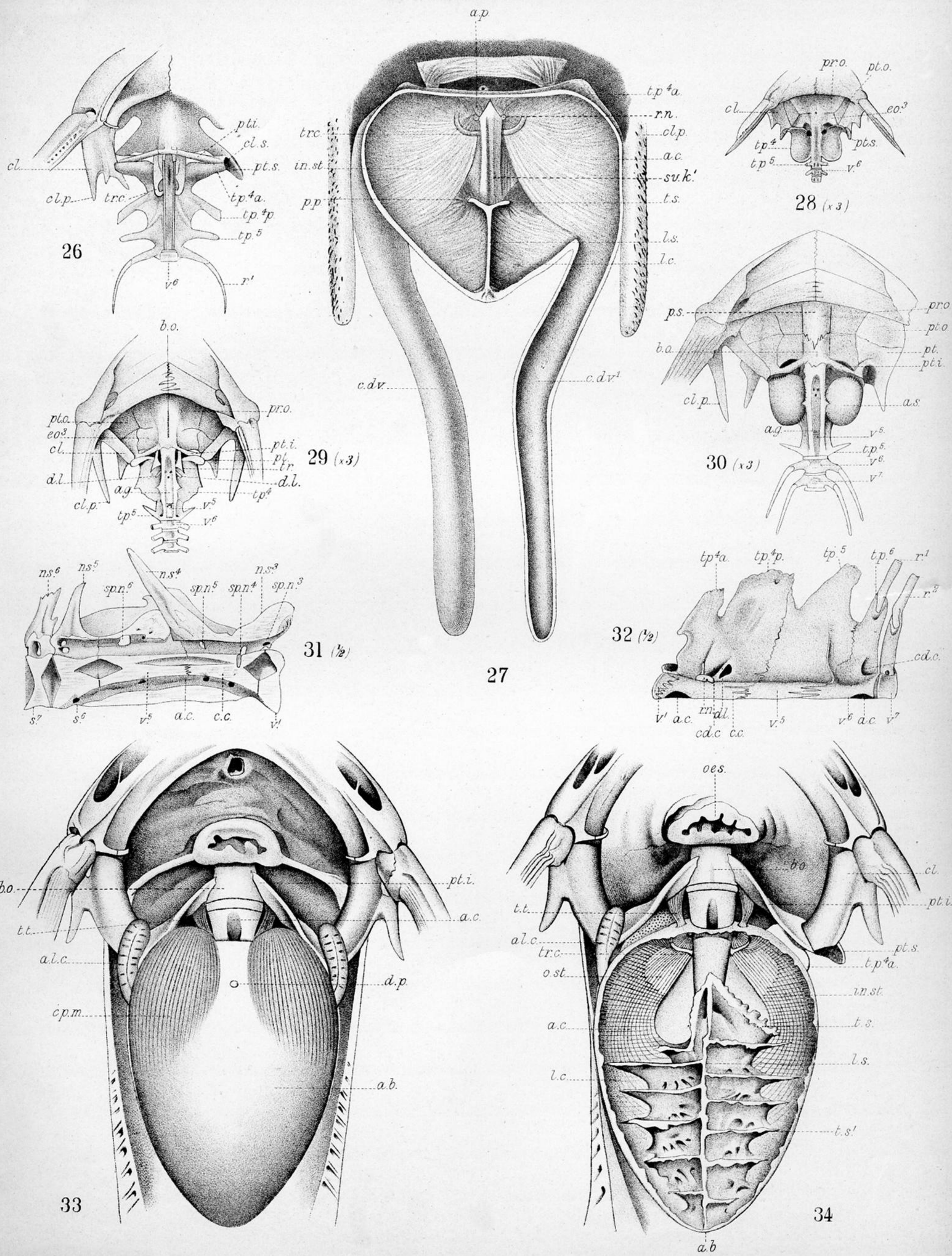

PLATE XIII.

Fig. 26.—*Pseudobagrus brachysoma*. Ventral view of the anterior vertebræ and the modified transverse processes.

Fig. 27.—*Rita crucigera*. Ventral view of the cavity of the air-bladder.

Fig. 28.—*Acrochordonichthys pleurostigma*. Base of the skull, and the modified anterior vertebræ; ventral view;  $\times 3$ .

Figs. 29 and 30.—*Akysis variegatus*.

Fig. 29. Base of the skull, and the anterior vertebræ; ventral view;  $\times 2$ .

Fig. 30. Ventral view of the air-sacs *in situ*;  $\times 3$ .

Figs. 31–34.—*Platystoma tigrinum*.

Fig. 31. Vertical longitudinal section through the anterior vertebræ;  $\frac{1}{2}$  nat. size.

Fig. 32. Ventral view of the left halves of the anterior vertebræ and their processes;  $\frac{1}{2}$  nat. size.

Fig. 33. Ventral view of the air-bladder *in situ*.

Fig. 34. Interior of the air-bladder; ventral view.

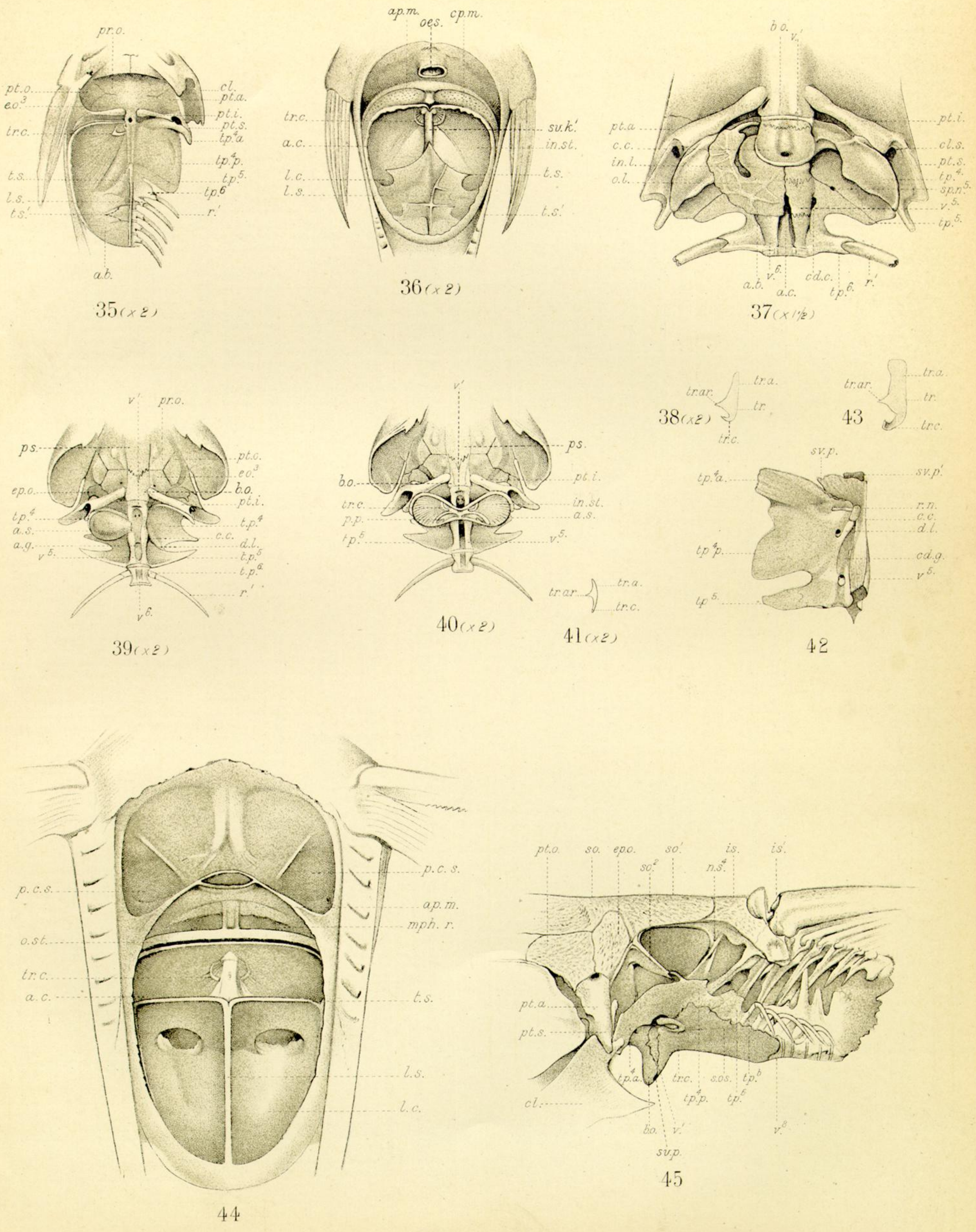

PLATE XIV.

Fig. 35.—*Piramutana piramuta*. Ventral view of the base of the skull and of the anterior vertebræ; the interior of the right half of the bladder is also shown;  $\times 2$ .

Fig. 36.—*Pimelodus ornatus*. Interior of the air-bladder; ventral view;  $\times 2$ .

Figs. 37, 38.—*Pimelodus sape*.

Fig. 37. Ventral view of the right half of the bladder and the left osseous capsule; the ventral part of the right capsule has been removed;  $\times 1\frac{1}{2}$ .

Fig. 38. The left tripus; ventral view;  $\times 3$ .

Figs. 39-41.—*Pimelodus pulcher*.

Fig. 39. Base of the skull, the right air-sac, the left osseous capsule, and the modified anterior vertebræ;  $\times 2$ .

Fig. 40. Ventral view of the interior of the two air-sacs;  $\times 2$ .

Fig. 41. Ventral view of the left tripus;  $\times 2$ .

Figs. 42-44.—*Auchenoglanis biscutatus*.

Fig. 42. Ventral view of the right halves of the anterior vertebræ and their processes.

Fig. 43. The left tripus; ventral view.

Fig. 44. Ventral view of the interior of the air-bladder.

Figs. 45-49.—*Arius pidada*.

Fig. 45. Lateral view of the hinder part of the skull and the anterior vertebræ.



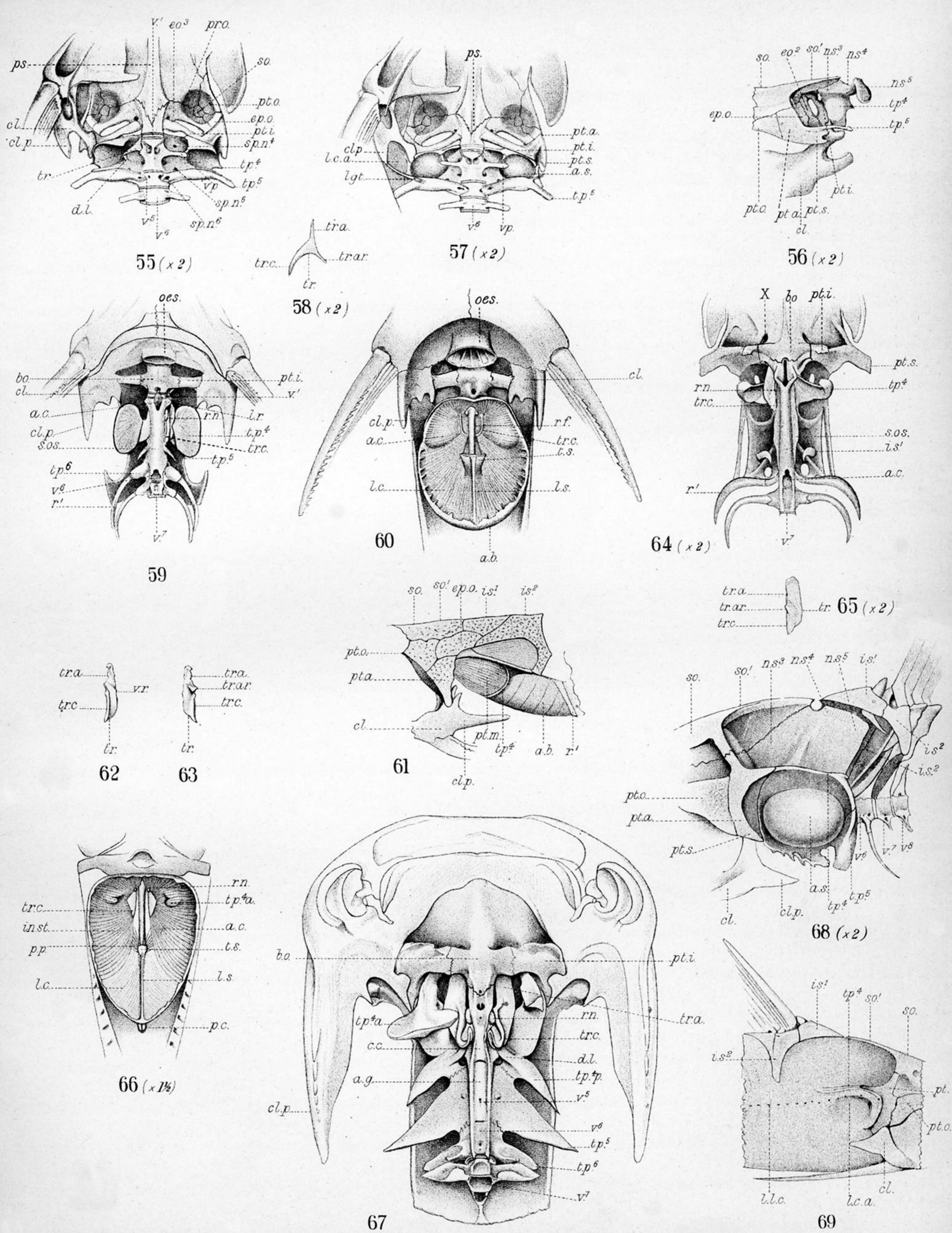

PLATE XVI.

Figs. 55-58.—*Glyptosternum platypogon*.

Fig. 55. The base of the skull, the anterior vertebræ, and the bony capsules for the air-sacs; ventral view;  $\times 2$ .

Fig. 56. Lateral view of the hinder part of the skull, the pectoral girdle, and the neural spines of the anterior vertebræ;  $\times 2$ .

Fig. 57. Ventral view of the two air-sacs, showing their relations to the osseous capsules;  $\times 2$ .

Fig. 58. The right tripus;  $\times 2$ .

Figs. 59-63.—*Auchenipterus nodosus*.

Fig. 59. Ventral view of the anterior vertebræ and the "elastic-spring" apparatus.

Fig. 60. Similar view of the interior of the air-bladder.

Fig. 61. Lateral view of the air-bladder and skull, showing the left protractor muscle of the mechanism.

Fig. 62. Ventral view of the right tripus.

Fig. 63. Dorsal view.

Figs. 64-66. *Oxydoras brevis*.

Fig. 64. Ventral view of the anterior vertebræ and the "elastic-spring" mechanism;  $\times 2$ .

Fig. 65. The left tripus; ventral view;  $\times 2$ .

Fig. 66. Ventral view of the interior of the air-bladder;  $\times 1\frac{1}{2}$ .

Fig. 67.—*Synodontis schal*. Ventral view of the anterior vertebræ and the "elastic-spring" apparatus.

Figs. 68-70.—*Callomystax gagata*.

Fig. 68. Side view of the anterior vertebræ, showing the left osseous capsule and its air-sac, the lateral cutaneous area of that side having been removed;  $\times 2$ .

Fig. 69. Lateral view of the anterior portion of the trunk.

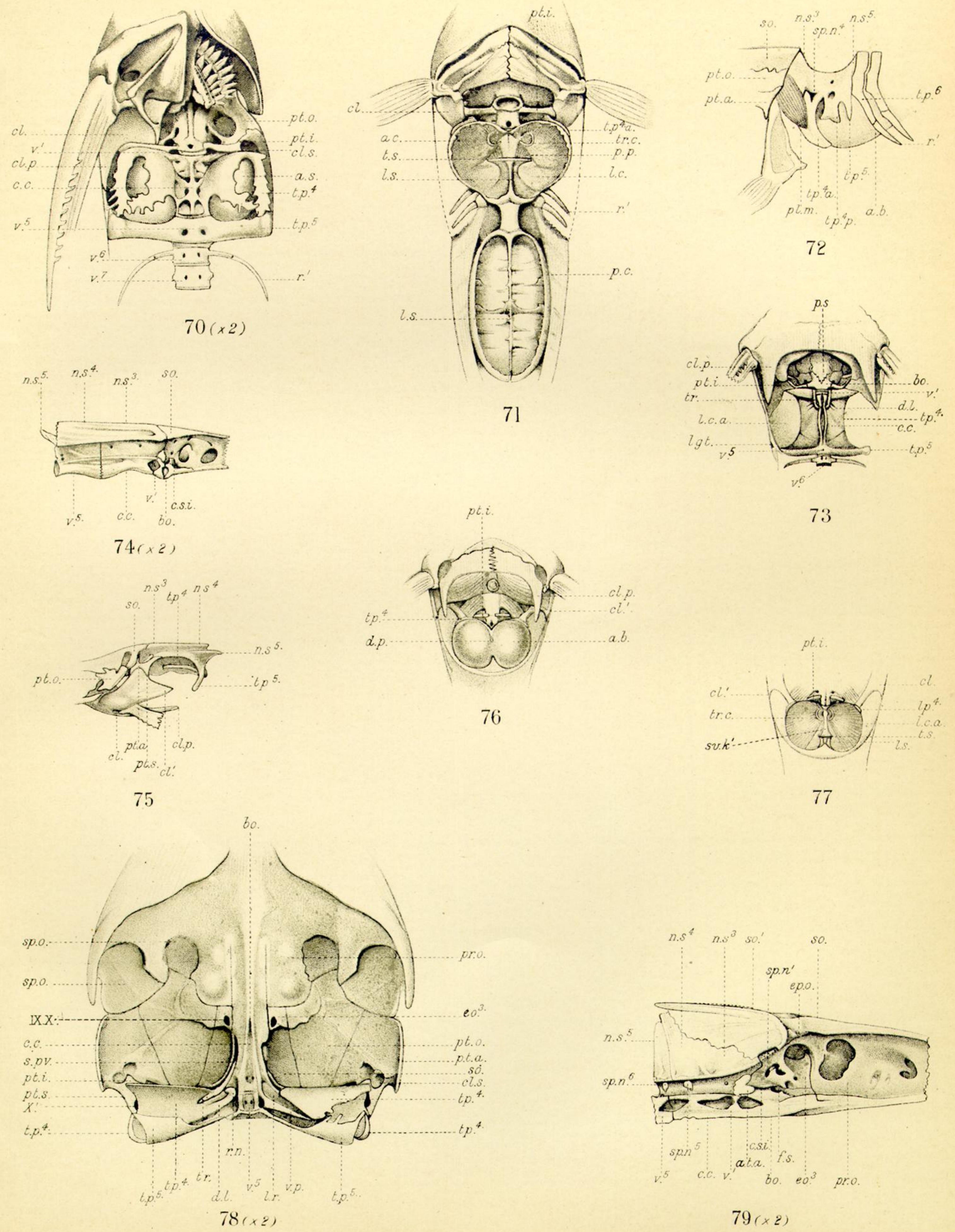

PLATE XVII.

Fig. 70. Ventral view of the osseous capsules and their contained air-sacs;  $\times 2$ .

Figs. 71, 72.—*Malapterurus electricus*.

Fig. 71. Interior of the air-bladder; ventral view.

Fig. 72. Side view of the hinder part of the skull and the anterior vertebræ, showing the left elastic-spring and its protractor muscle.

Figs. 73–77. *Aspredo cotylophorus*.

Fig. 73. Base of the skull and the anterior vertebræ; ventral view.

Fig. 74. Vertical longitudinal section of the hinder part of the skull and the anterior vertebræ;  $\times 2$ .

Fig. 75. Lateral view of the hinder part of the skull, the pectoral girdle, and the first, the complex, and the fifth vertebræ;  $\times 2$ .

Fig. 76. Ventral view of the two air-sacs *in situ*.

Fig. 77. Ventral view of the interior of the two air-sacs.

Figs. 78–81.—*Clarias Nieuhofii*.

Fig. 78. The base of the skull, the anterior vertebræ, and the two osseous capsules;  $\times 2$ .

Fig. 79. Vertical longitudinal section of the hinder part of the skull and the anterior vertebræ;  $\times 2$ .

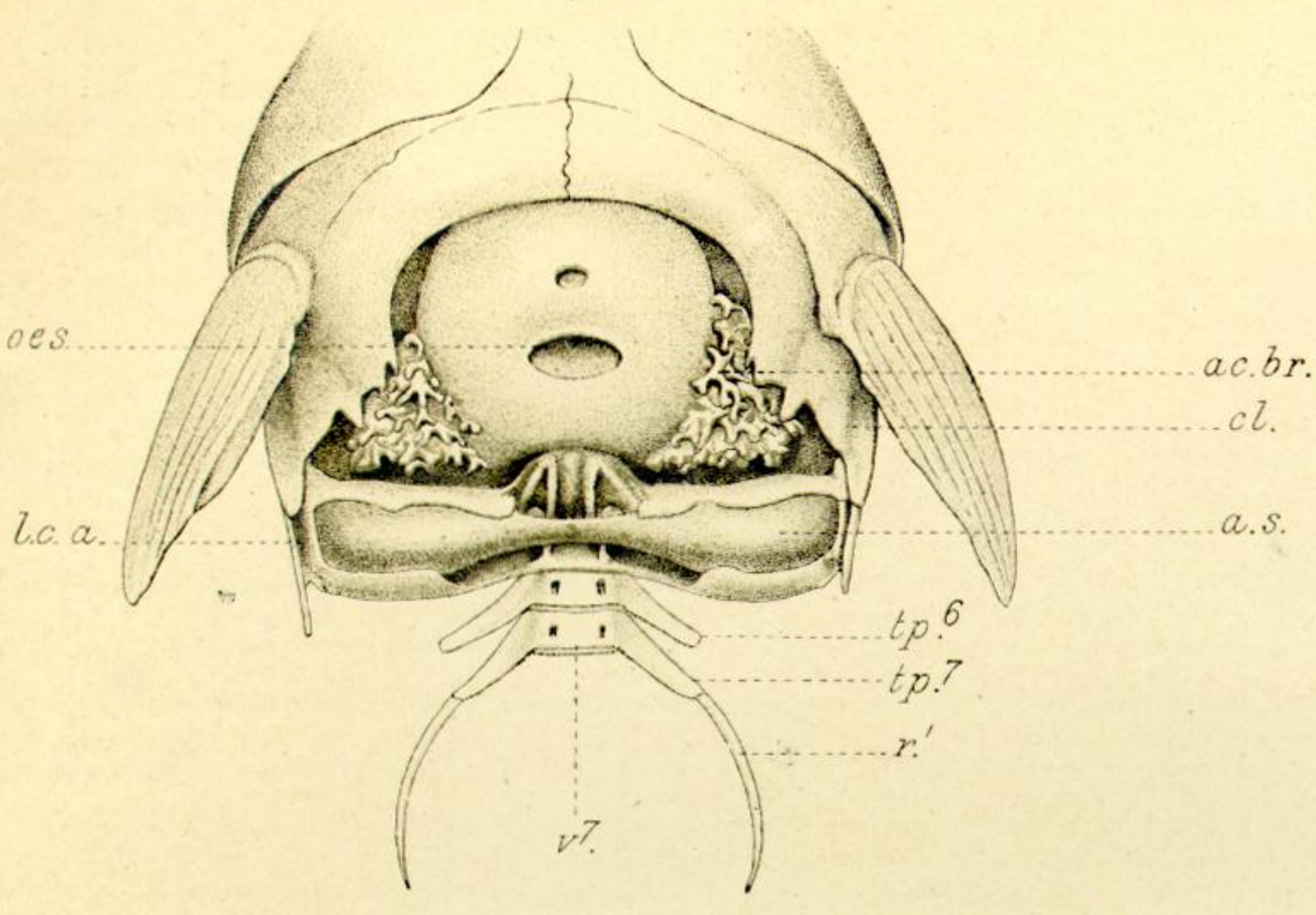

80

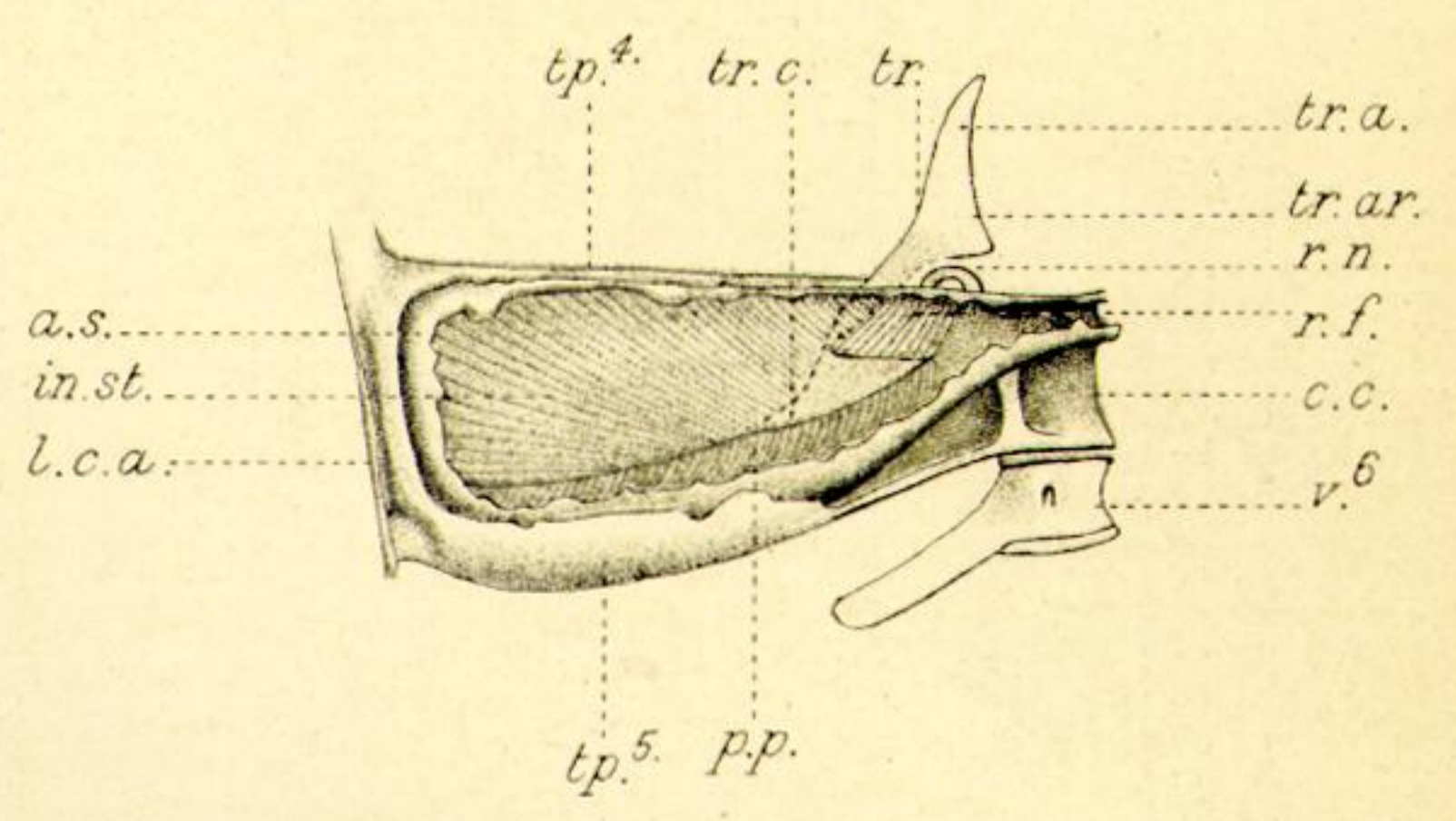

81 (x 2)

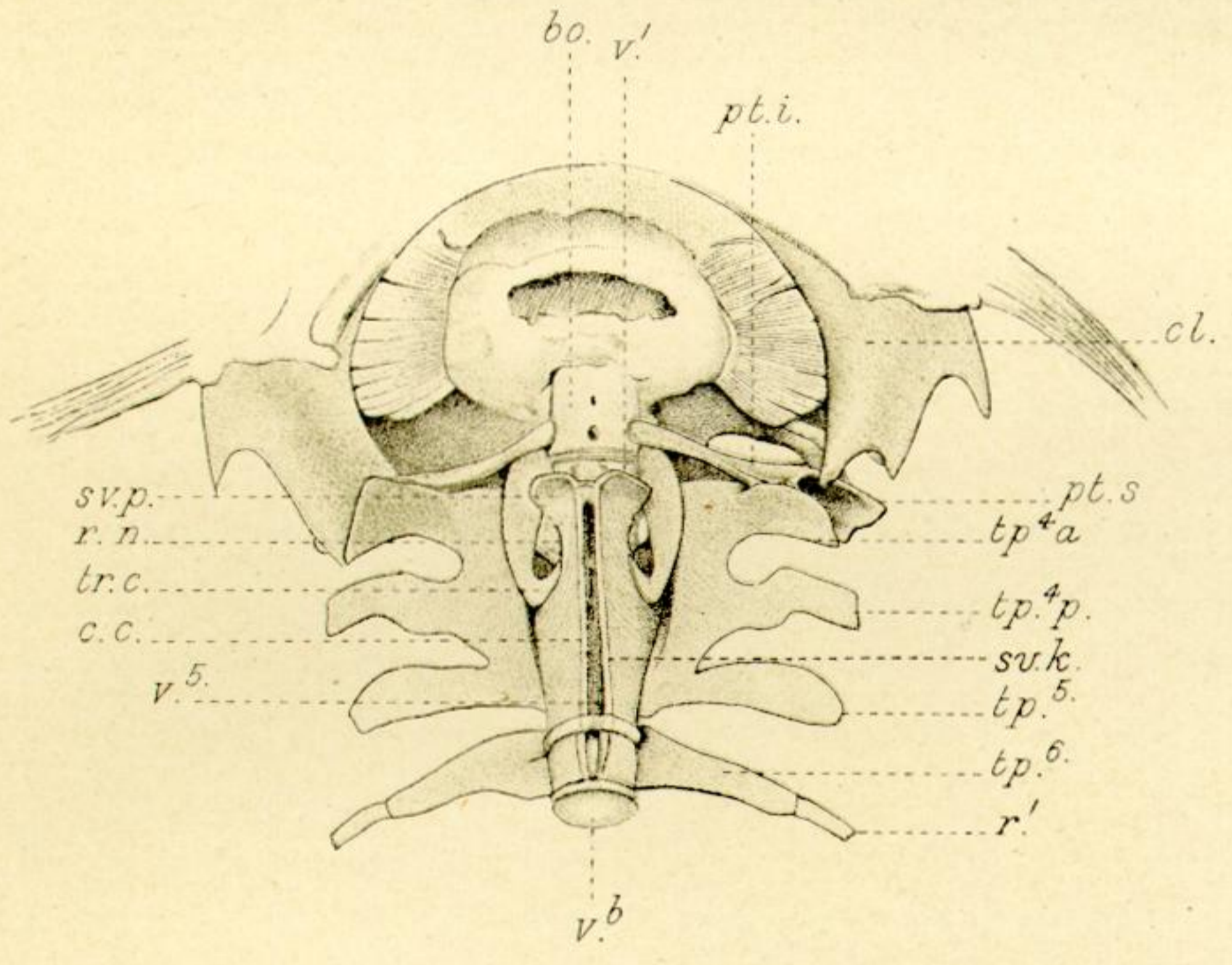

82 (x 1 1/2)

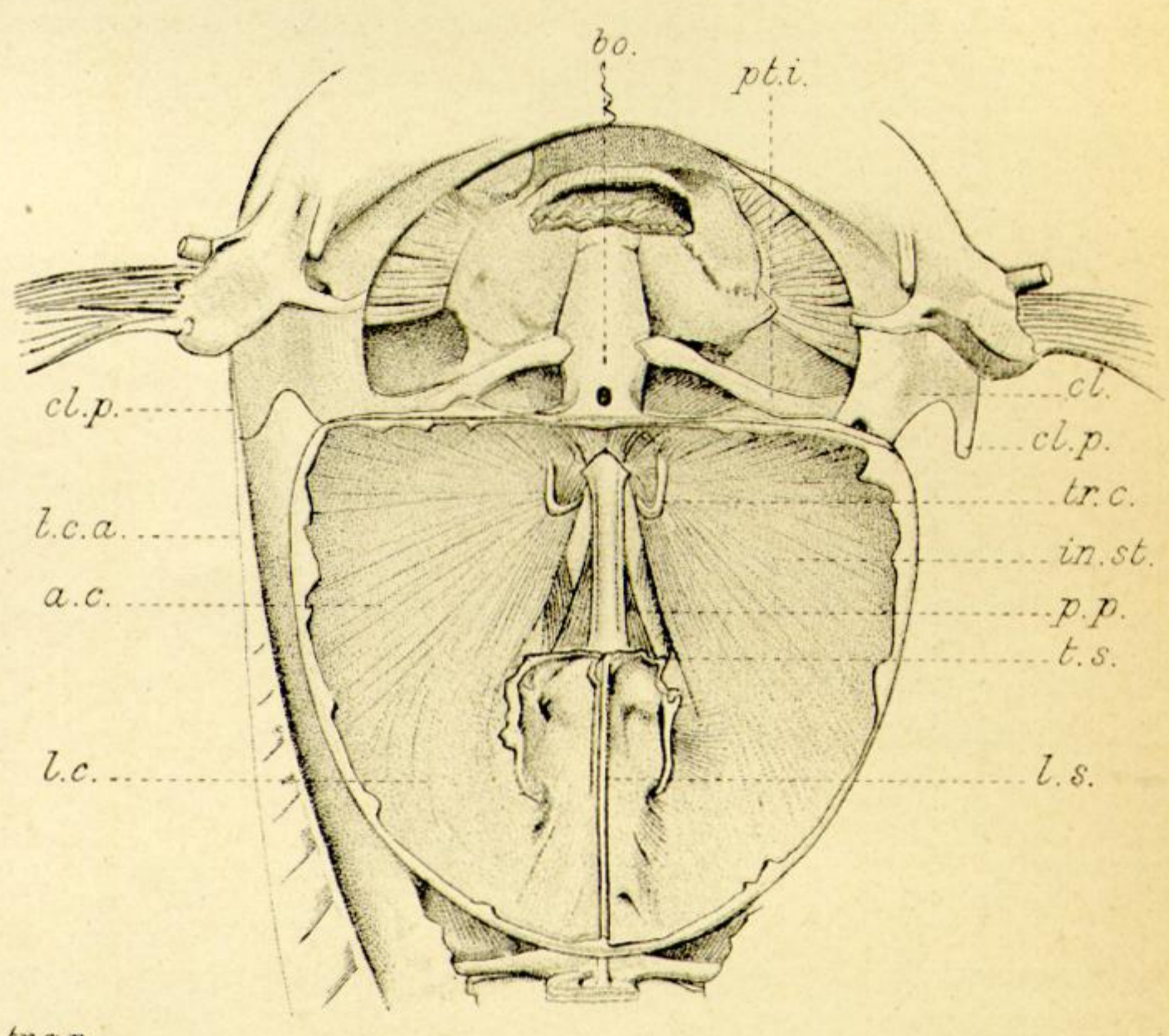

83 (x 2)

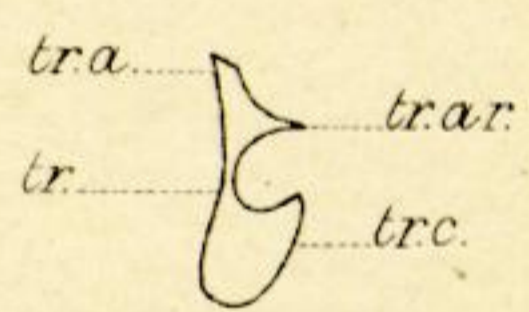

83a (x 1 1/2)

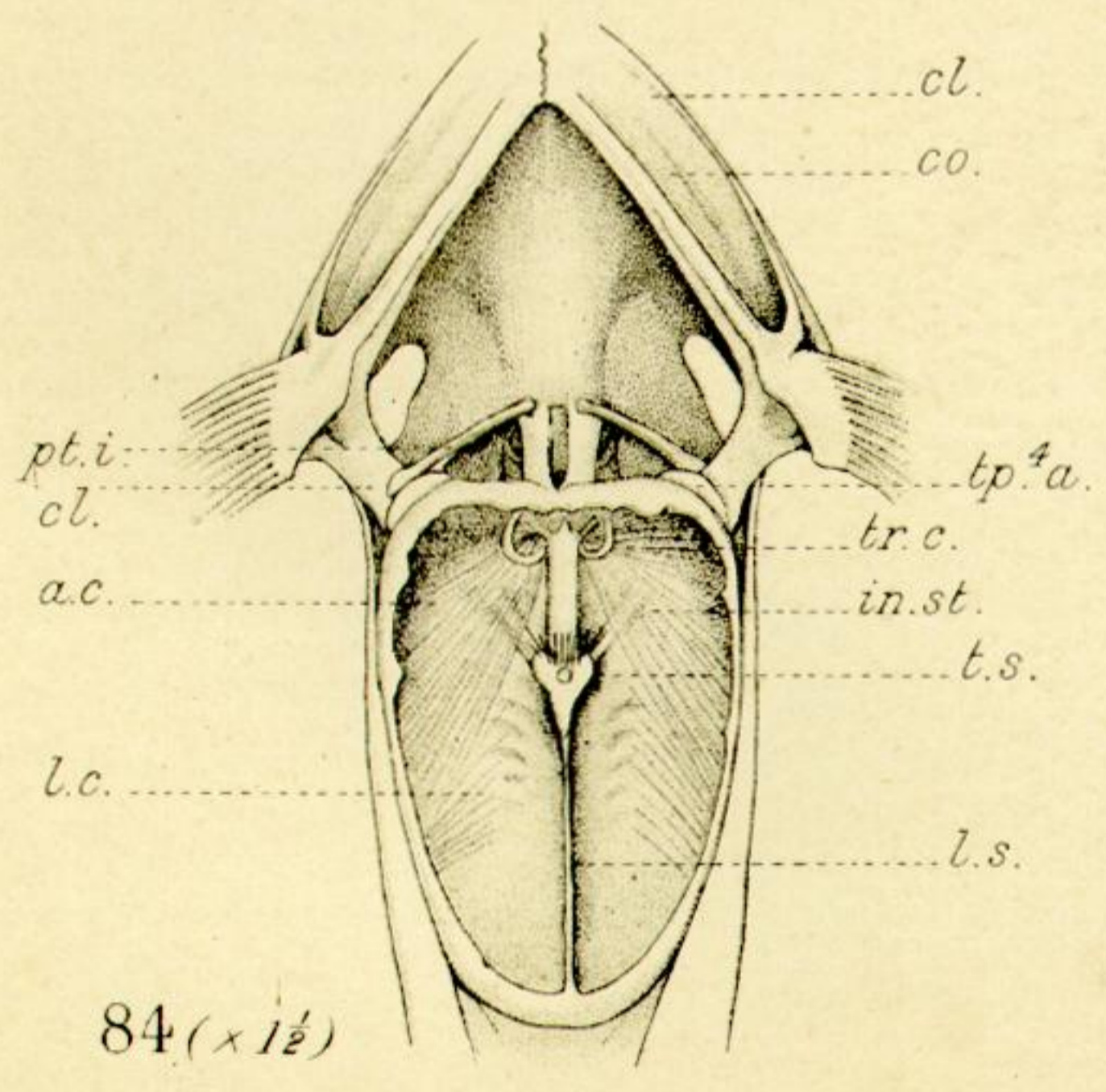

84 (x 1 1/2)

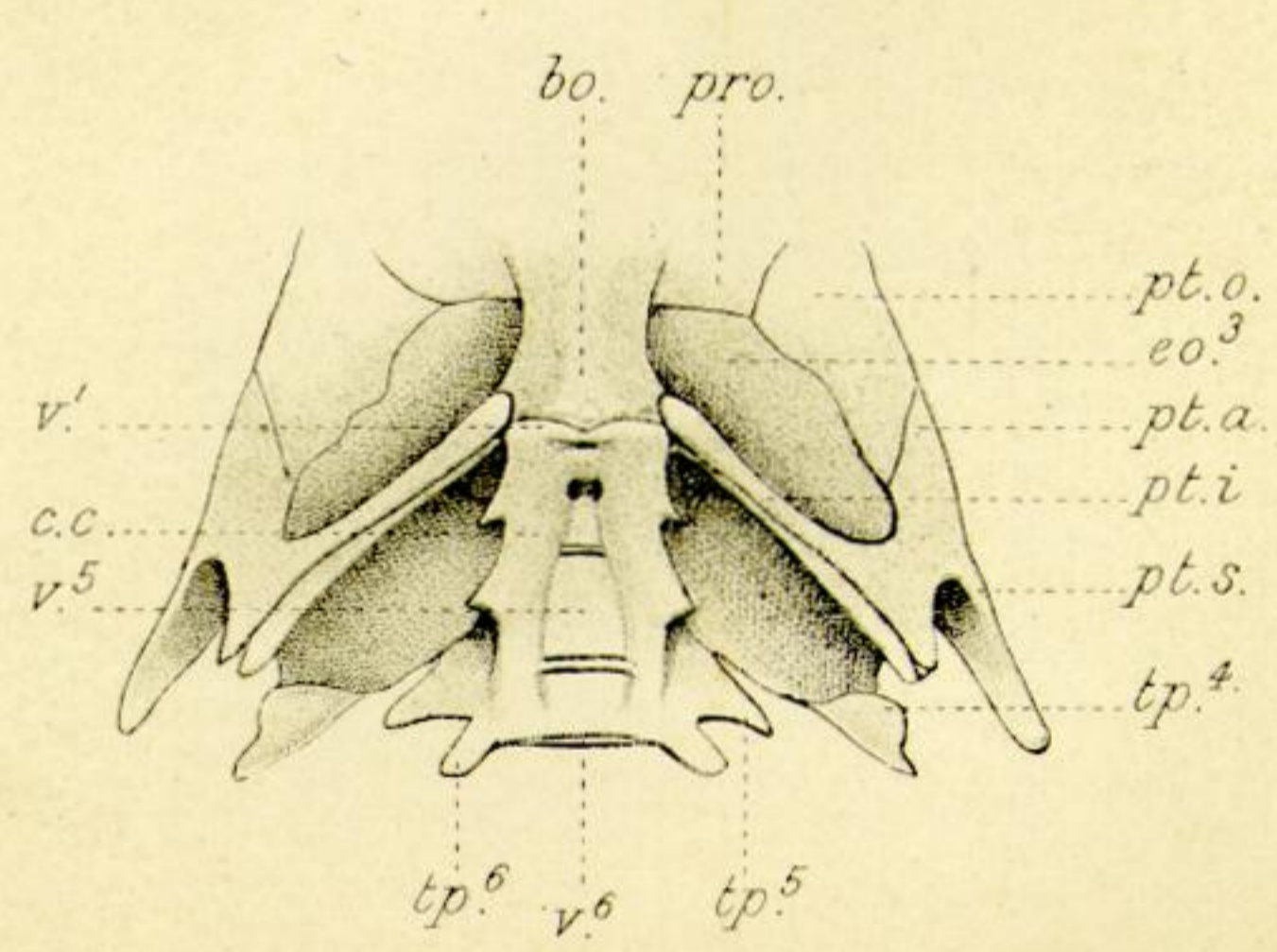

85 (x 2)

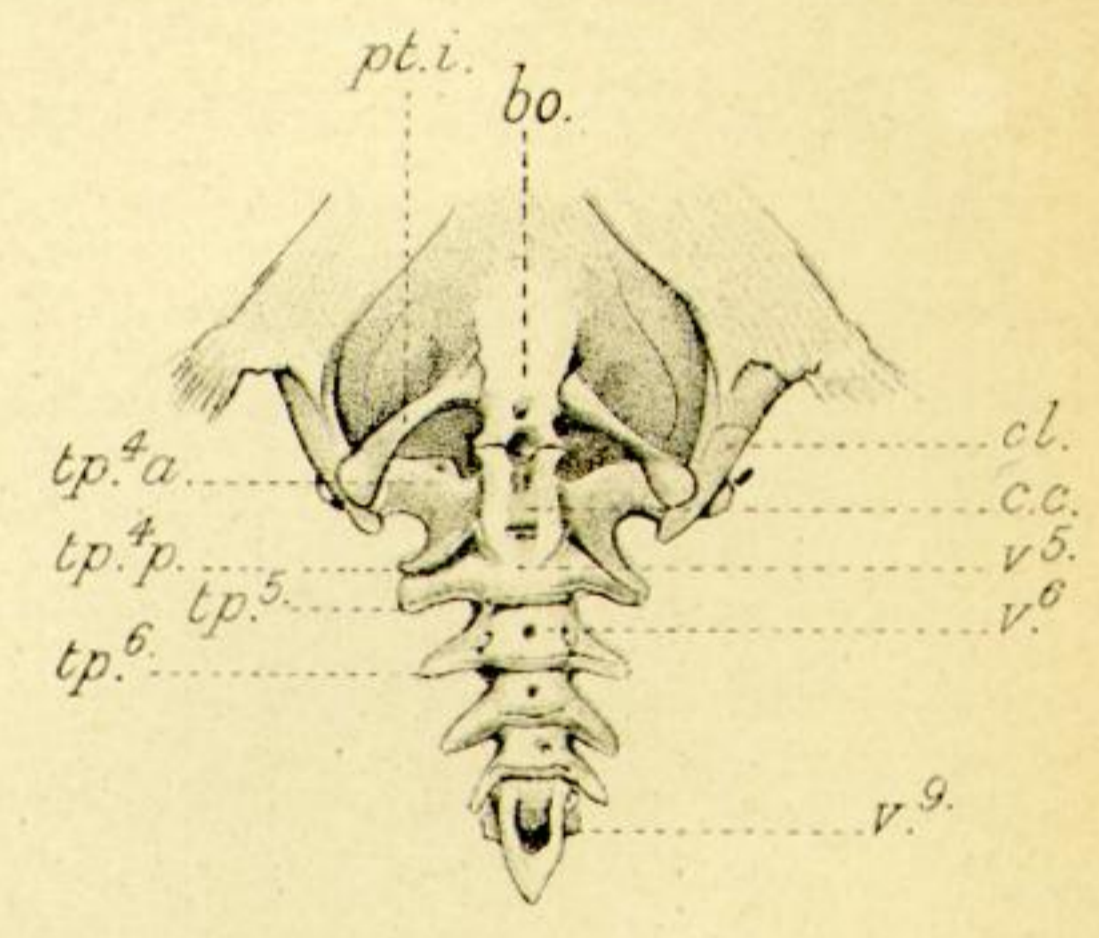

86 (x 2)

PLATE XVIII.

Fig. 80. Ventral view of the two air-sacs *in situ*.

Fig. 81. Ventral view of the interior of the right air-sac, showing the fibres of the dorsal wall and their relations to the tripodes; x 2.

Figs. 82, 83.—*Plotosus canius*.

Fig. 82. Ventral view of the anterior vertebræ and the tripodes; x 1 1/2.

Fig. 83. Interior of the air-bladder; ventral view; x 2.

Fig. 83A.—*Saccobranchus fossilis*. Ventral view of tripus; x 1 1/2.

Fig. 84.—*Silurus glanis*. Interior of the air-bladder; ventral view; x 1 1/2.

Fig. 85.—*Eutropiichthys vacha*. The base of the skull, the bony capsules, and the anterior vertebræ; x 2.

Fig. 86.—*Cryptopterus hexapterus*. Ventral view of the anterior vertebræ and their processes; x 2.

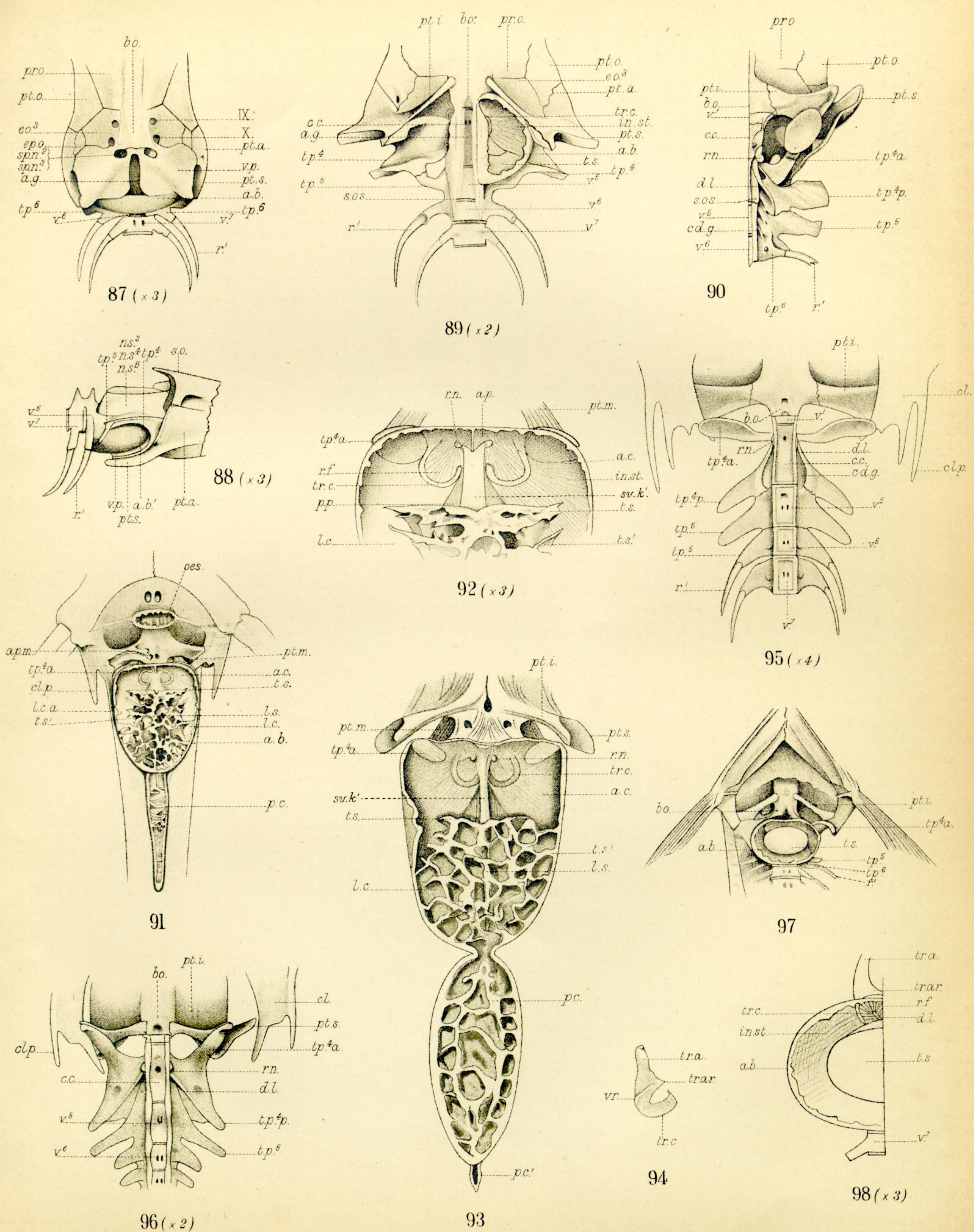

PLATE XIX.

Figs. 87, 88.—*Ailia bengalensis*.

Fig. 87. The base of the skull and the osseous recesses for the tubiform air-bladder; ventral view;  $\times 3$ .

Fig. 88. Lateral view;  $\times 3$ .

Fig. 89.—*Schilbichthys garua*. Ventral view of the base of the skull, the right osseous capsule, and the interior of the left half of the air-bladder;  $\times 2$ .

Figs. 90, 93, 94.—*Pangasius djambal*.

Fig. 90. Ventral view of the left halves of the anterior vertebræ, and the left "elastic-spring."

Fig. 93. Interior of the air-bladder; ventral view.

Fig. 94. The right tripus; ventral view.

Figs. 91, 92.—*Pangasius Buchanani*.

Fig. 91. Interior of the air-bladder; ventral view.

Fig. 92. Ventral view of the anterior chamber;  $\times 3$ .

Fig. 95. *Pangasius juaro*.—Ventral view of the anterior vertebræ, and the "elastic-spring" apparatus;  $\times 4$ .

Fig. 96. *Pangasius micronema*.—Ventral view of the anterior vertebræ and their processes, showing the absence of an "elastic-spring" mechanism; the left clavicle is withdrawn from its socket;  $\times 2$ .

Figs. 97, 98.—*Silondia gangetica*.

Fig. 97. Ventral view of the cavity of the air-bladder.

Fig. 98. Enlarged view of the right half;  $\times 3$ .